

BAST-221C/CH-BW2

Wireless BACnet Communicating Thermostat for Multi-Stage Heating/Cooling/Ventilation

BASstat

Wireless Multi-Stage Thermostat User Manual



UM-15090500-AA3

CONTEMPORARY CONTROLS®

Trademarks

BASautomation, Contemporary Controls, and CTRLink are registered trademarks of Contemporary Control Systems, Inc. BACnet is a registered trademark of the American Society of Heating, Refrigerating and Air-Conditioning Engineers, Inc. Other product names may be trademarks or registered trademarks of their respective companies.

Copyright

© Copyright 2025, by Contemporary Control Systems, Inc. All rights reserved. No part of this publication may be reproduced, transmitted, transcribed, stored in a retrieval system, or translated into any language or computer language, in any form or by any means, electronic, mechanical, magnetic, optical, chemical, manual, or otherwise, without the prior written permission of:

Contemporary Control Systems, Inc.	Tel:	+1-630-963-7070
	Fax:	+1-630-963-0109
	E-mail:	info@ccontrols.com
Contemporary Controls Ltd	Tel:	+44 (0)24 7641 3786
	Fax:	+44 (0)24 7641 3923
	E-mail:	ccl.info@ccontrols.com
Contemporary Controls (Suzhou) Co. Ltd	Tel:	+86 512 68095866
	Fax:	+86 512 68093760
	E-mail:	info@ccontrols.com.cn
Contemporary Controls GmbH	Tel:	+49 (0)341 520359 0
	Fax:	+49 (0)341 520359 16
	E-mail:	ccg.info@ccontrols.com

Disclaimer

Contemporary Control Systems, Inc. reserves the right to make changes in the specifications of the product described within this manual at any time without notice and without obligation of Contemporary Control Systems, Inc. to notify any person of such revision or change.

Contents

- 1 Introduction 3
 - 1.1 Features and Benefits 4
 - 1.2 Product Image and Main Features 5
- 2 Specifications 7
 - 2.1 Inputs 7
 - 2.2 Outputs..... 7
 - 2.3 Communication 7
 - 2.4 Electrical..... 7
 - 2.5 Environmental 8
 - 2.6 Electromagnetic Compatibility 8
 - 2.7 Mechanical (all dimensions are in mm) 9
- 3 Installation 11
 - 3.1 Terminal Block Pin Assignments 11
 - 3.2 Limited Power Source 11
 - 3.3 Power Supply Precautions 12
 - 3.4 Wiring Diagram 12
- 4 Operation 13
 - 4.1 User Mode..... 13
 - 4.2 Control Type..... 15
 - 4.3 Engineering Mode Menu 19
 - 4.4 BACnet Objects and Network Configuration 26
- 5 Warranty..... 40
- 6 Returning Products for Repair..... 41
- 7 Declaration of Conformity 41

1 Introduction

The BAST-221C is a member of the BASstat BACnet Communicating Thermostat series. It provides multi-stage heating and cooling control in an attractive wall-mounted enclosure with a large LCD display. Intended for use with rooftop units (RTUs), the thermostat can control one or two stages of heating and one or two stages of Direct Expansion (DX) cooling. The BASstat is BACnet compliant and BTL listed to ensure seamless integration into BACnet networks. The BAST-221C-BW2 communicates to a BACnet client over Wi-Fi and can be integrated into any 802.11 b/g/n Wi-Fi network. A large, easy to read LCD display indicates setpoint, space temperature and current mode of operation using graphical icons.

The BASstat has a built-in space temperature sensor with provision for remote wired 3k Ω NTC thermistor sensor or temperature value can be sent by another communicating device over the BACnet network. “221CH” thermostat models support relative humidity reading with a built-in sensor which is shown on the display and as a BACnet object, as well as a calculated dew point value as a BACnet object (no control action is taken based on humidity). Both models have five relays – two for stage heating, two for stage cooling and one for fan. The BASstat is configurable locally using the Engineering Menu or via a network connection to a BACnet client. Contemporary Controls’ free [BACnet Discovery Tool \(BDT\): www.ccontrols.com/sd/bdt.htm](http://www.ccontrols.com/sd/bdt.htm) can be used for initial discovery and configuration of the thermostat over BACnet. Control algorithm parameters such as deadband, proportional gain, integral rate, stage trip points and stage widths are all configurable. This BASstat also features configurable short-cycle protection, maximum cycles per hour, fan control and occupancy selection. All states and pending delays are indicated by graphical icons on the thermostat display.

The numerous features available in the BASstat can be configured by the systems integrator to meet user requirements in two different ways. One way is using a button sequence on the thermostat in order to enter the Engineering Menu - which requires physical access to the thermostat. Optionally, the buttons could be locked to limit user access to Engineering Menu after installation is complete. The second method is configuring the thermostat over the BACnet network using a BACnet client device or software such as Contemporary Controls’ free [BACnet Discovery Tool \(BDT\)](http://www.ccontrols.com/sd/bdt.htm). All features available are configurable using both methods.

1.1 Features and Benefits

- Stand-alone thermostat algorithm or fully BACnet network-controllable
- BTL listed with B-ASC device profile for seamless integration into BACnet networks
- 24VAC (+/-10%) power input
- Manual-changeover or Auto-changeover control types
- BACnet/IP over Wi-Fi can be integrated into any 802.11 b/g/n Wi-Fi network
- Suitable for single to multi-stage heat/cool control applications with manual or automatic changeover between heating and cooling modes
- Adjustable algorithm applied to multi-stage step control
- Adjustable minimum on/off time staging for optimizing runtime
- Effective run time accumulation for system runtime for energy consumption metering
- Full configurable control parameters such as deadband, proportional gain, integral rate, stage trip points, and cycle time
- Adjustable minimum/maximum set point ranges
- Three options for temperature reading:
 - Built-in temperature sensor, or
 - Remote sensor (RS) input for wiring in a remote temperature sensor (NTC 3k Ω), or
 - BACnet network temperature override
- Occupancy status can be switched from thermostat buttons by occupants or using BACnet network command.
- Separate adjustable occupied set points for heating and cooling mode
- Separate adjustable unoccupied set points for heating and cooling mode
- Fan can be set to run continuously or automatically depending upon fan mode
- Non-volatile memory (EEPROM) retains user settings during power outage
- Thermostat buttons are selectively lockable to prevent unauthorized control
- °C or °F display
- Control outputs disabled during “OFF” state for safety

1.2 Product Image and Main Features

BASstat 221C-BW2

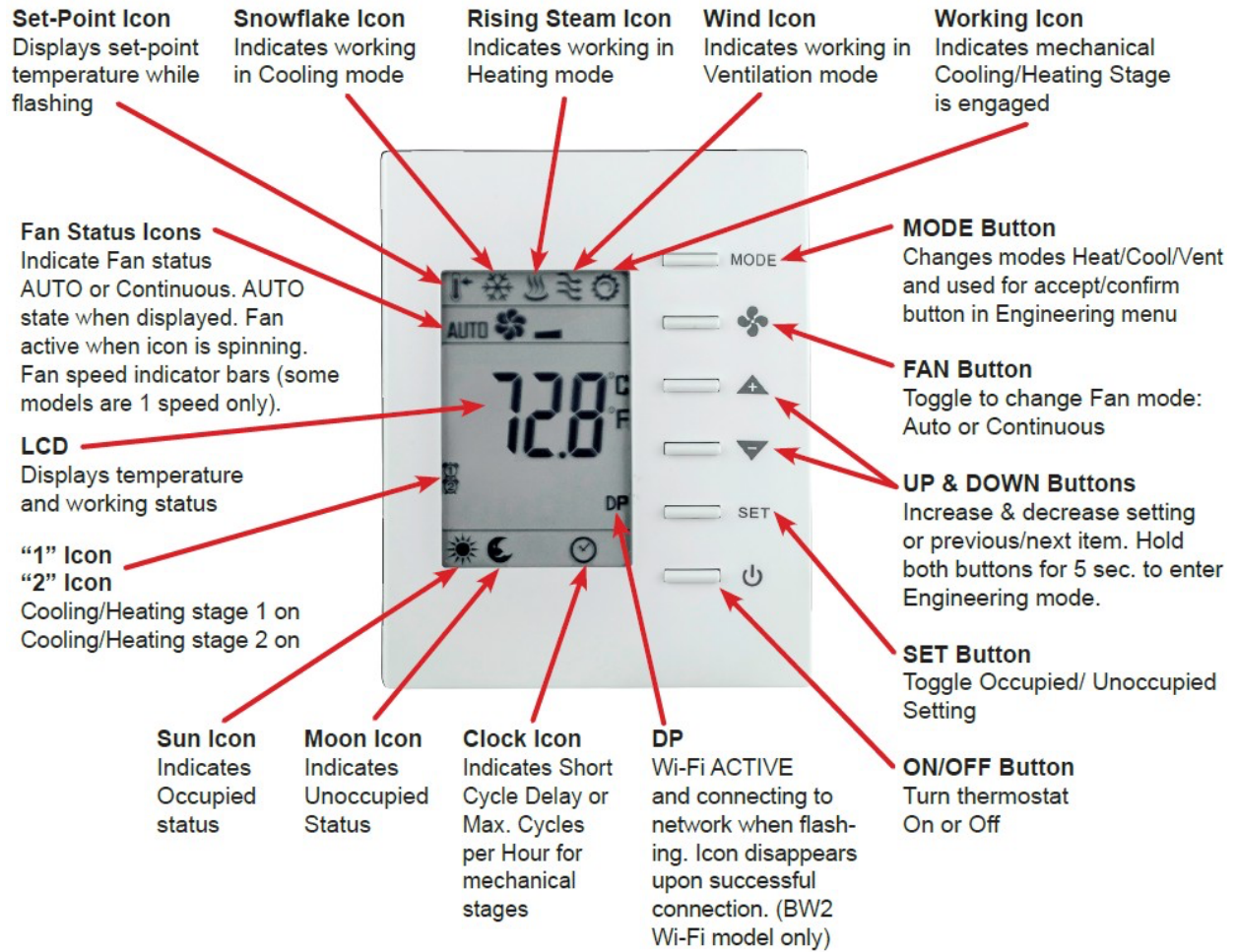

BASstat 221CH-BW2

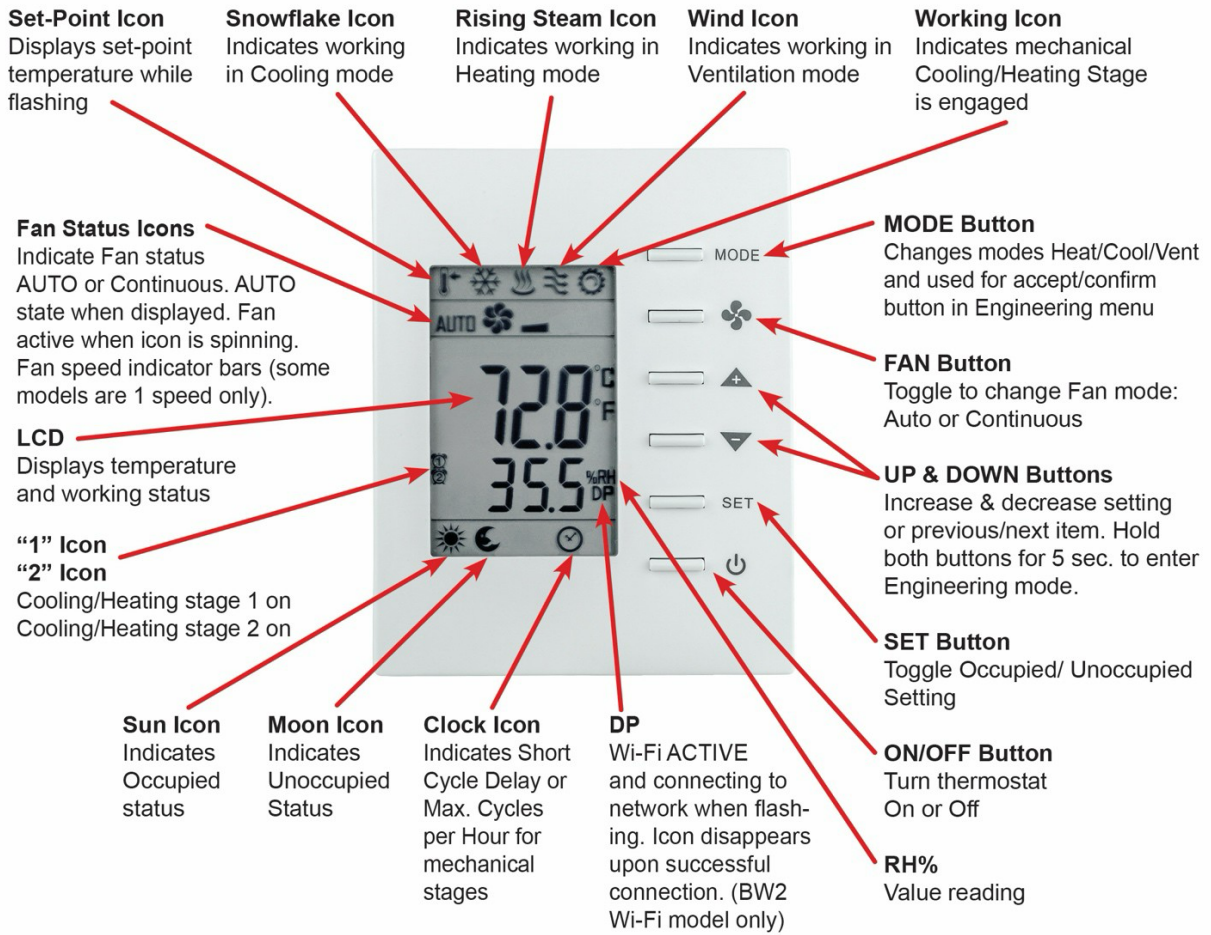

2 Specifications

2.1 Inputs

Item	Description
Temperature Display Range	14 to 140°F (-10 to +60°C)
Temperature Display Resolution	0.1°F (0.1°C)
Temperature Accuracy	±1.8°F (±1.0°C) with all outputs off
Setpoint Range	32 to 122°F (0 to 50°C) in 0.5° (°F or °C) increments
Remote Temperature Sensor	Provision for NTC Type 3kΩ thermistor

2.2 Outputs

Item	Description
Relay Outputs	Heating 1, Heating 2, Cooling 1, Cooling 2, Fan
Contact Rating	SPST 2A at 30 VAC with inductive load
Minimum contact life	100,000 cycles

2.3 Communication

Item	Description
Protocol Compliance	BACnet/IP with B-ASC, BTL Listed
Physical Layer	802.11 b/g/n Wi-Fi network
Cabling	None

2.4 Electrical

Item	Description
Supply Voltage and Current	24 VAC (±10%) 5 VA
Power Source Class	NFPA 70 (NEC) Article 725 Part III Class 2
Internal Power Supply	Half-wave rectified and filtered DC

2.5 Environmental

Item	Description
Operating Temperature	32°F to 122°F (0 to 50°C)
Storage Temperature	14 to 140°F (-10 to +60°C)
Relative Humidity	5 to 95% non-condensing

2.6 Electromagnetic Compatibility

The BAST-221C complies with the following specifications and bears the CE mark in accordance with the provisions of the Electromagnetic Compatibility (EMC) Directive 2004/108/EC based on the following specifications:

Standard	Test Method	Description
EN 61000-6-2	IEC 61000-4-2	Electrostatic Discharge Immunity
EN 61000-6-2	IEC 61000-4-3	Radiated, Radio-Frequency, Electromagnetic Field Immunity
EN 61000-6-2	IEC 61000-4-4	Electrical Fast Transit/Burst Immunity
EN 61000-6-2	IEC 61000-4-5	Voltage Surge Immunity
EN 61000-6-2	IEC 61000-4-6	Immunity to Conducted Disturbances
EN 61000-6-2	IEC 61000-4-8	Power Frequency Magnetic Field Immunity
EN 61000-6-2	IEC 61000-4-11	Voltage Dips and Interruptions
EN 61000-6-3	IEC 61000-3-2	Limits for Harmonic Current Emissions
EN 61000-6-3	IEC 61000-3-3	Limitation of Voltage Fluctuations and Flicker in Low Voltage Supply Systems

2.7 Mechanical (all dimensions are in mm)

Wiring: 14 to 22 AWG wires or 1.5mm² wires

Mounts directly onto wall, panel, standard 65×65mm junction box (hole pitch 60 mm) or standard 2×4-inch vertical junction box (hole pitch 83.5mm)

Width: 94mm Height: 118mm Depth: 34mm

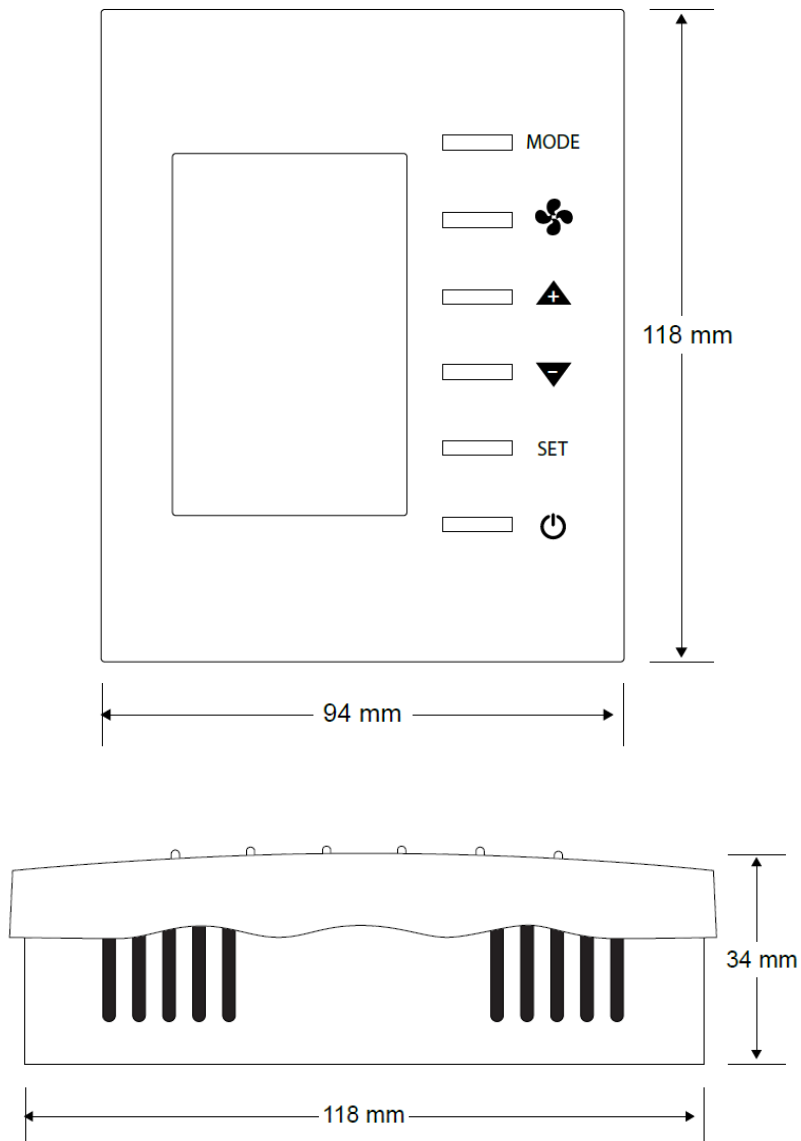

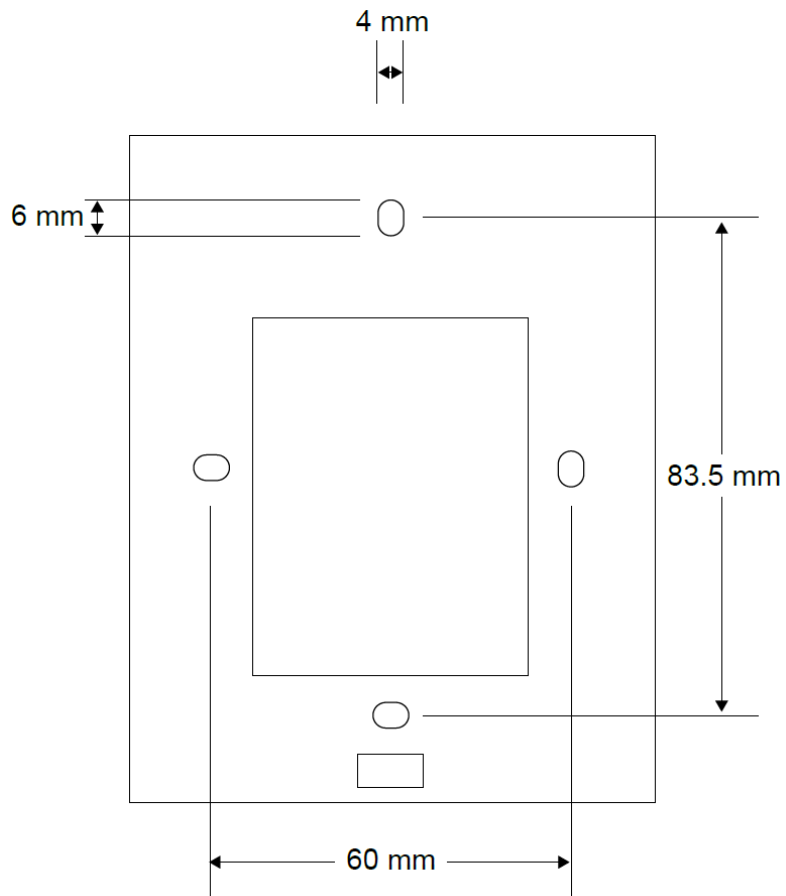
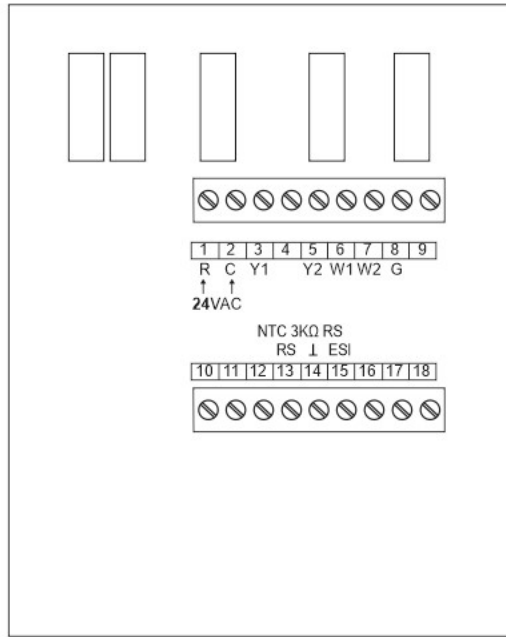

3 Installation

The BASstat is intended for surface-mount installation at eye-level on an interior wall, away from direct sunlight or direct air movement. The display (top half) can be removed from its base by loosening the small Philips screw at the bottom of the display. Once the display is removed from the base, the base can be mounted onto the wall with appropriate fasteners. If a single-gang electrical junction box is to be used, the top and bottom mounting holes will align with the screw holes in the junction box.

3.1 Terminal Block Pin Assignments

Two 9-pin terminal blocks provide for all field connections. Terminal markings for mechanical equipment follow NEMA DC 3-2003 convention. For single-stage operation, connect Y wire to Y1 and W wire to W1. The remote sensor input (RS) is at terminals 13 and 14. The remote occupancy (ESI) input is a dry contact closure input located at terminals 14 and 15. The BASstat is intended to be powered by a Class 2 compliant power source and only accepts 24VAC.

Number	Mark	Comment	Number	Mark	Comment
1	R	24 VAC high-side	10		
2	C	24 VAC common	11		
3	Y1	Cooling Stage 1	12		
4			13	RS	Remote Sensor Input
5	Y2	Cooling Stage 2	14	GND	Ground
6	W1	Heating Stage 1	15	ESI	Energy Saving Input
7	W2	Heating Stage 2	16		
8	G	Fan	17		
9			18		

3.2 Limited Power Source

The BASstat is intended to be powered by a Class 2 compliant power source and only accepts 24VAC with no more than 5VA of power consumption and should be powered by a Class 2 power source complying with the requirements of the National Electric Code (NEC) article 725. The power rating of a Class 2 power source is limited to 100 VA. The transformer or power supply complying with the Class 2 rating must carry a corresponding listing from a regulatory agency such as Underwriters Laboratories (UL).

3.3 Power Supply Precautions

Internally, the BASstat utilizes a half-wave rectifier and can share the same AC power source with other half-wave rectified devices. Sharing AC power with full-wave rectified devices is NOT recommended. AC power sources that power several half-wave devices have a common secondary connection called COMMON, LO, or GROUND. Connect the HOT side of the secondary to the 24 VAC high side input on the BASstat and the LO side to 24 VAC common.

WARNING: Devices powered from a common AC source could be damaged if a mix of half-wave and full-wave rectified devices are both present. If you are not sure of the type of rectifier used by another device, do not share the AC source with it.

3.4 Wiring Diagram

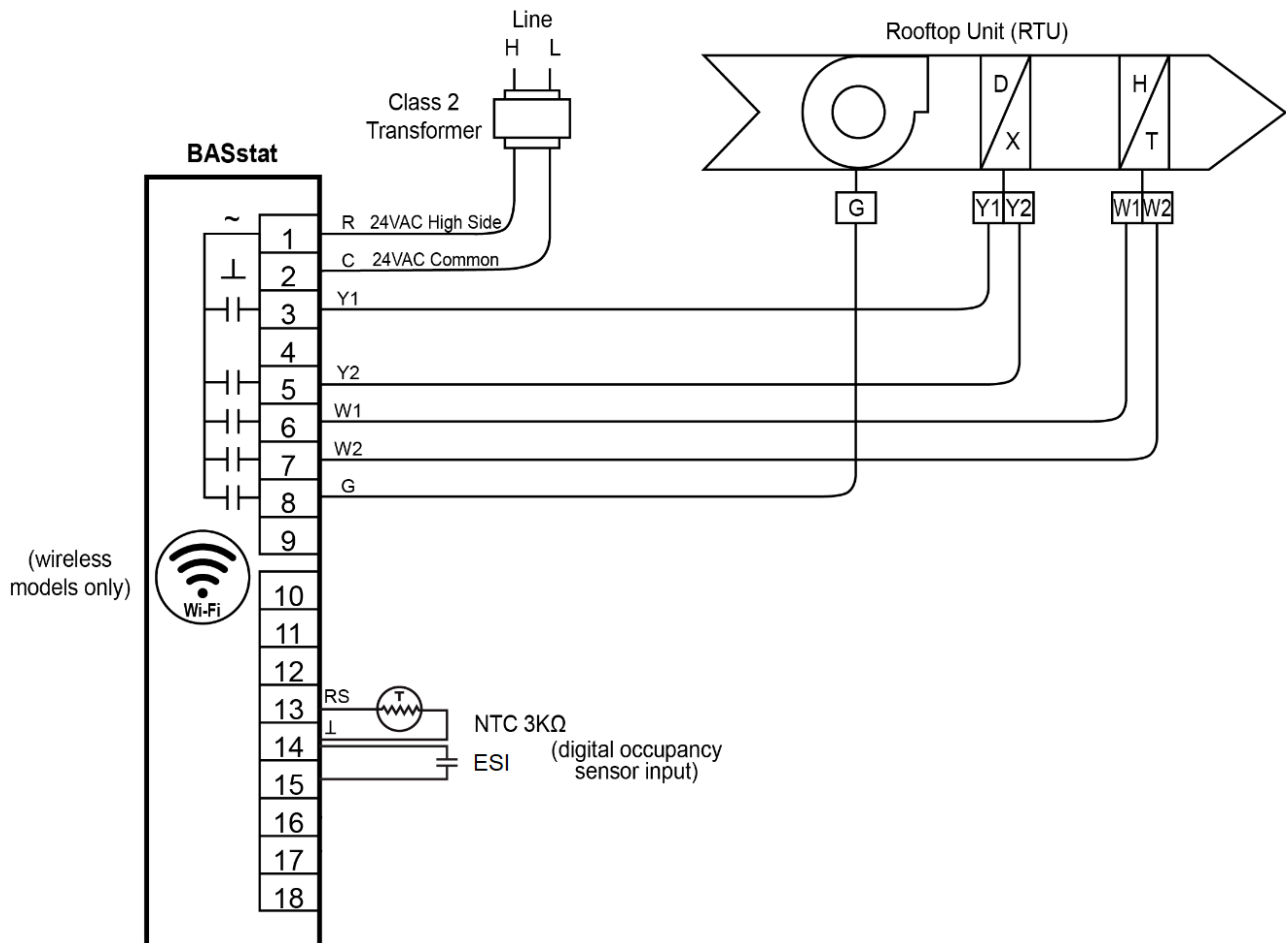

Wiring: 14 to 22 AWG wires or 1.5mm² wires



4 Operation

4.1 User Mode

User-side control is accomplished with six buttons – MODE (Heat, Cool, or Ventilate), FAN (Auto or Continuous), UP, DOWN, SET, and POWER. There are also options to lock select buttons or all buttons on the thermostat to limit user access if so required. A large LCD display indicates setpoint, space temperature, occupancy status, and current mode of operation using graphical icons.



System modes (Cool, Heat, Ventilate) available to the user are dependent on control type chosen from Engineering Menu (tyPE) or BACnet object [MSV7] Control Type. (See section 4.2 *Control Type* of this manual). System modes and button operation may be limited by the installer, especially if the thermostat is completely controlled over BACnet network.

The first tier of operation includes the following settings as shown below. To operate the thermostat:

1. The POWER button  toggles between ON or OFF states to start / stop the thermostat outputs. This will disable control (ON/OFF control can be accomplished over BACnet as well).
2. At power ON, press any button to start the User Mode operation. Press the MODE button  to toggle between different HVAC operating modes such as Cool, Heat, or Ventilate@Cool and Ventilate@Heat.





Press the UP/ DOWN buttons   to increase/decrease temperature

setpoint or rotate the values of a setting. Press the FAN button  to toggle fan modes of AUTO or CONTINUOUS. If no AUTO icon is displayed, the fan is in CONTINUOUS fan mode and it will run continuously until commanded off using button on thermostat or BACnet command. If AUTO icon is flashing, the fan is operating under delay timer and will shut off automatically when delay timer expires.

Press the SET button  and use UP/ DOWN buttons   to toggle the unit between Occupied or Unoccupied states when outside of scheduled operation. Use SET or MODE to apply (SET button can be locked in applications forbidding occupancy state user control).

3. Thermostat will return to normal display with the last known setting if there's no button pressed for 10 seconds.

User Mode Thermostat Operation

#	Item	Description	Remarks
1	Normal Display	Display current room or set-point temperature	Use the (SP) parameter in the Engineering Menu or [MSV6] <i>Display Option</i> for BW2 or [MSV7] <i>Display Option</i> for B2 model to choose Current room or Set-point temperature on display.
2	Temperature Setpoint Setting using Up/Down Arrows 	Set the desired temperature	The [AV0] / [AV3] Cool / Heat Occupied and [AV8] / [AV9] Unoccupied Cool / Heat temperature setpoints BACnet objects can be used to write or force the setpoint to a desired value from BACnet supervisor.
3	Mode Select 	Select the working mode: Cooling (❄), Heating (🔥), or Ventilating (🌀).	After pressing the MODE button, press the UP/ DOWN button to rotate the selections. Dependent on Control Type.
4	Fan Auto/Continuous 	Change the Fan mode between Auto or Continuous.	When AUTO is displayed, the fan is handled automatically. When AUTO is flashing, the fan is working under a delay timer. When FAN icon is spinning but AUTO is not displayed, the fan will run continuously until commanded off.
5	Occupancy Setting 	Press SET, Used UP and DOWN arrows to toggle between the Occupied and Unoccupied setting. Use MODE or SET buttons to apply.	The SET button could be locked for applications forbidding user occupancy state control.

User Mode Flow Chart

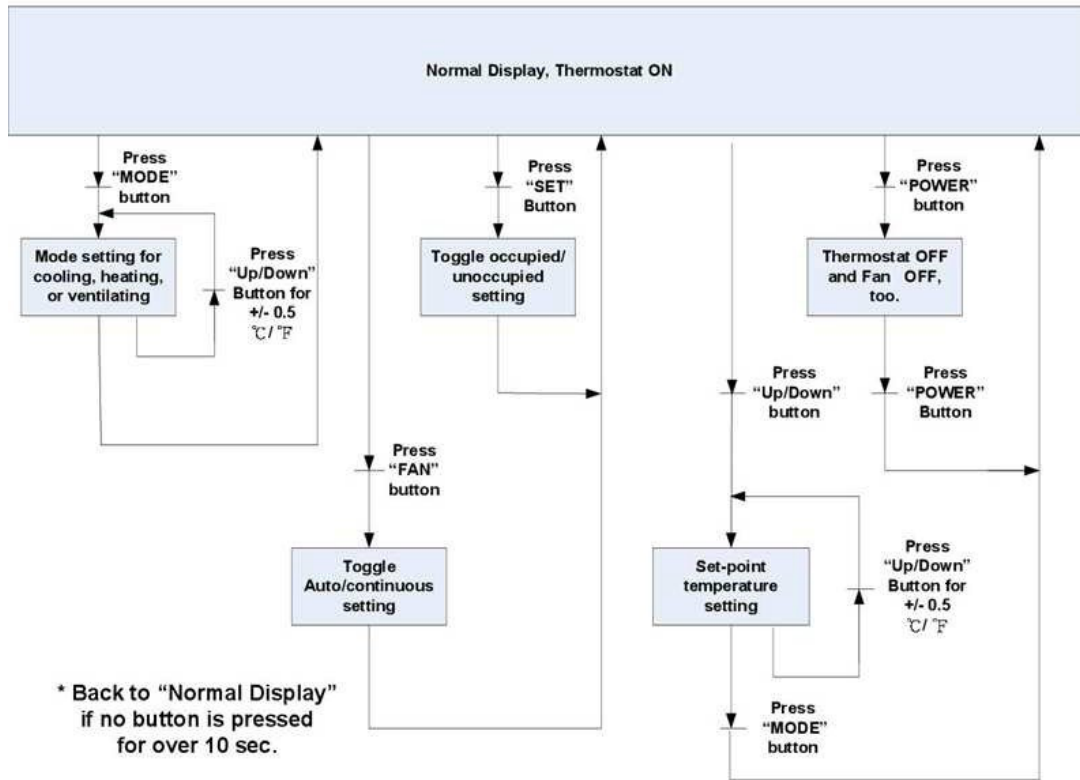

4.2 Control Type

Control Type, System Mode and Algorithm Configuration

The BAST-221C supports two different control types, selectable in Engineering Menu item (tyPE) BACnet object [MSV7].

Control type is only configurable by the installer using Engineering Mode Menu or BACnet supervisor. The installer must decide the control type suitable for the application, set it to a static value, or program the BACnet supervisor to change the control type automatically. The default control type is set to 2-stage Heating and Cooling with Auto Changeover. This is the most common control type. 2-stage Heating and Cooling with Manual Changeover can be used to limit frequent automatic change of system modes (Cool or Heat).

System modes available to the user are dependent on control type chosen from Engineering Menu (tyPE) or BACnet object [MSV7] Control Type.

Dual Stage Heat and Cool with Auto Changeover – This the default control type in this thermostat. Mostly used for standalone operation. The thermostat will switch between Cool and Heat modes automatically. In this control type, the user will be presented with a choice of

Heat or Ventilation@Heat when the thermostat is in *Heat* mode (automatic), and *Cool* or *Ventilation@Cool* when the thermostat is in *Cool* mode (automatic).

Dual Stage Heat and Cool with Manual Changeover – In this control type the thermostat will wait for a command from user or BACnet supervisor to switch between Cool and Heat modes. The user will be presented with a choice of Heat or Ventilation@Heat when the thermostat is in Heat mode, and Cool or Ventilation@Cool when the thermostat is in Cool mode. The user can choose to switch between Cool and Heat modes using the MODE button.

BACnet controlled – In this control scheme, the built-in thermostat algorithm can be bypassed, and the thermostat can be controlled over the BACnet network with commands from the supervisor device. The logic executing in the supervisor (such as Niagara or Sedona logic) can control the thermostat over the BACnet network. To put the thermostat in BACnet network control mode, use the Lock [AV18] object bit 9: Control DOs by thermostat algorithm “0” (default) or BACnet supervisor “1” (add decimal=512).

Cool Only (nullified/disabled in firmware), and Heat Only (nullified/disabled in firmware) control types are listed in the BACnet object and Engineering Menu object but are not available for use.

Fan Output in Heat Mode

By default, the BASstat thermostat will not provide Fan output signal when in Heat Mode since most HVAC comfort systems such as RTU systems provide their own fan control signal based on a delay after a call for heating. This can be configured from Engineering Menu item (F-Ht) or BACnet object [BV15] Fan Output For Heating. The default value is “0”. To enable fan control signal output for heating coming from the BASstat, set this value to “1”.

Algorithm

- A PID adaptive control algorithm is applied to minimize overshoot, in addition to proportional band (Stage Width) and derivative (Differential) calculation.
- When the thermostat is active (either the heating or cooling stage is on), a “Working (🔧)” icon will be shown on the LCD.
- Stage 1 operation will show the icon (🔧¹). Stage 2 operation will display (🔧²).

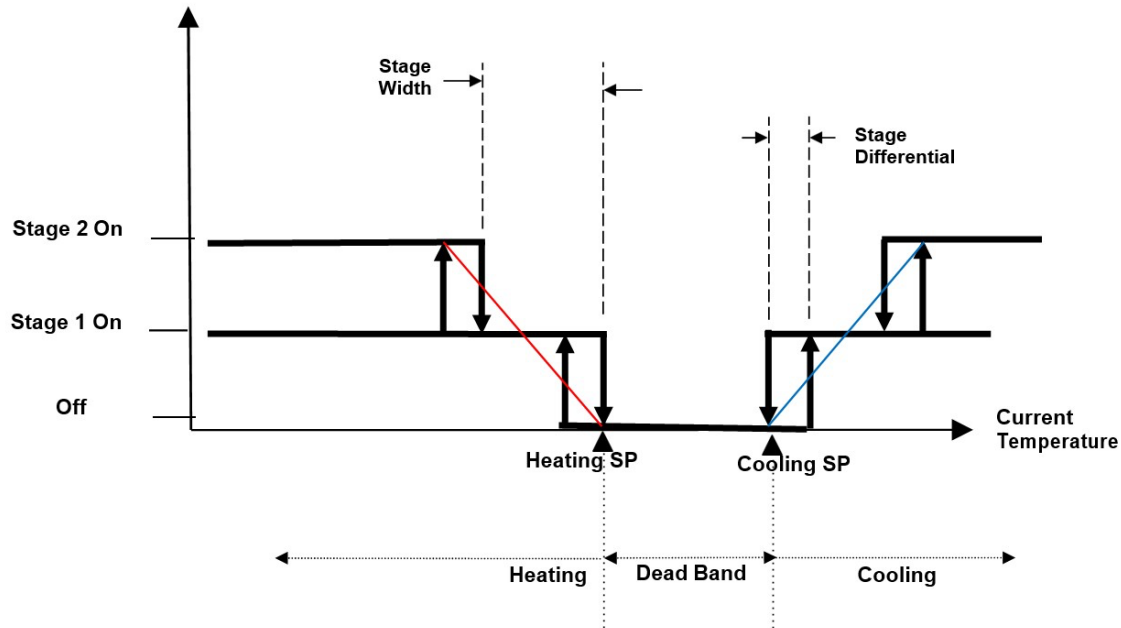

System Mode

- The default control type is 2-stage cooling and heating with automatic changeover. This makes the thermostat operate fully stand-alone. Control Type can be selected in (tyPe) or [MSV7]. Manual Changeover control type allows restriction of mode selection to Cool only or Heat only in applications where necessary.
- Occupied Cooling [AV0] and Heating [AV3] set points and Unoccupied Cooling [AV8] and Heating [AV9] setpoints can be set individually for cooling and heating modes, with either manual or automatic changeover control. Minimum deadband [AV7] can be programmed as well.
- For cooling/ heating with manual changeover control, cooling or heating can be selected by pressing the MODE button or using a BACnet command to object [MSV1]. In application where user control needs to be limited, the lock button function can be used to disable MODE button.

Fan Control Output

- Fan Output for Heating - the fan output for Heat mode is disabled "0" in [BV15] by default. The thermostat lets the RTU circuitry control the fan during Heat mode. Fan output can be enabled "1" for Heat mode if desired [BV15].
- Lowest Fan Speed is the speed the fan will default to after a control action (Heating or Cooling). If the lowest fan speed [MSV4] is set as "Stop (1)", the fan will be automatically shut off after the control action (Heating or Cooling) and a 2-minute fan-off time delay. During this delay time, the AUTO icon will be flashing, and the fan will shut off after the 2-minute time delay expires. If lowest fan speed is set to "Low (2)" the fan will run continuously after a control action.

This feature is useful for thermostat models with multiple fan speeds.

- Fan Mode can be toggled between AUTO or CONTINUOUS by using the FAN button on the thermostat (user) or BACnet object [MSV0] Fan Mode (BACnet supervisor). By default, this value is set to “Auto(1)”, the AUTO icon is displayed, and the fan will be controlled automatically. To put the fan in CONTINUOUS mode set to “Low(2)” this will cause the fan to run continuously (no AUTO icon is displayed). Fan icon spinning when fan is active. Optionally, the FAN button can be locked to limit user access to this feature or the BACnet supervisor can be programmed to default the thermostat to certain state at the end of an occupancy cycle.

Short Cycle and Maximum Cycles per Hour

- There are short cycle and maximum cycles per hour protection for both cooling and heating modes [AV23 – 26] Cooling Short Cycle Delay, Cooling Maximum Cycles per Hour and Heating Short Cycle Delay, Heating Maximum Cycles per Hour.
- The short cycle time (in minutes) will determine the minimum on time and minimum off time of each stage before changing its state. The default setting is 3 minutes.
- Maximum cycles per hour will count the number of cycles in an hour. When the cycle count reaches the maximum cycles in an hour, it won't allow additional cycles until the next hour.
- When a stage change is pending due to a Short Cycle Delay or a Maximum Cycle count, the Clock icon  will appear on the LCD.
- To disable short cycle checking, set the short cycle to 0 minutes. NOTE: Do not use this value unless the heating and cooling equipment is equipped with an internal timer. Damage to equipment may occur.

Floating Deadband

- The Heat and Cool temperature setpoints could be “attached” together. This means that as one setpoint is adjusted and “hits” against the deadband region, it will “push” the deadband region and the other setpoint along the temperature setpoint axis to allow for adjustment while maintaining the configured deadband. If the setpoint is adjusted back the other way, it will “pull” the deadband region and the other setpoint along the temperature setpoint axis.

Minimum Cooling Setpoint and Maximum Heating Setpoint



- Minimum Cooling Setpoint will be confined by set point low limit plus dead band and Minimum cooling setpoint [AV-39] default: 18°C/65°F
- Maximum Heating Setpoint will be confined by set point high limit minus dead band and Maximum heating setpoint [AV-40] default: 25°/77°F

Assigned Current Temperature

A current temperature value can be assigned thru BACnet AV-1 to take place of the onboard temperature sensor value. The assigned value is valid if BACnet communication is driving a flip-flop signal to (BV-16: heartbeat signal) within the (AV-29: Heartbeat Rate time) period (in seconds). Otherwise, the assigned temperature will revert back to the onboard sensor reading.

Occupancy Setting

There are three ways to define thermostat occupancy state. **NOTE:** Occupancy will be detected by ESI contact by default.

- Energy Savings Input (ESI) This is a dry contact input meant for communication from a customer supplied occupancy sensor. (default)
- Occupancy status (occupied/unoccupied) can be set by a BACnet supervisor using writable object *ESI Contact Definition [BV14]*. “0” for occupied, and “1” for unoccupied. E12/AV18 must be set with a value of 64 (disabled) in advance (E12/AV18 is set as 0 by default)
- User control of occupancy state is allowed from the SET button if E12/ AV18 Lock has the ESI Contact disabled. Pressing the SET button and UP/DOWN buttons will toggle the occupancy state. Press SET button to confirm. The SET button can work in conjunction with *BACnet occupancy Command [BV14]* on last-write-wins basis. The SET button could be locked to limit user control (use *Lock [AV18]* BACnet object or (LOC) Engineering Menu item to lock SET button). In this case only the BACnet supervisor can set occupancy states.
- *Occupancy Status [B10]* is a read-only BACnet object indicating current occupancy state - “0” for occupied, and “1” for unoccupied. (AV18 is set as 0 by default).
- When in unoccupied state, a Moon () icon will be displayed on the LCD and the thermostat will change the set-point temperatures to the *Unoccupied Cool* and *Unoccupied Heat* setpoints [AV8 – 9]. When the state changes back to occupied, the thermostat will return to the occupied set-point values for *Cooling* and *Heating Temperature Setpoint [AV0, AV3]* and a sunlight icon () will be displayed to indicate occupied state on LCD.

4.3 Engineering Mode Menu

Thermostat configuration can be performed using the Engineering Mode Menu described below or BACnet objects using a BACnet client tool such as Contemporary Controls free BACnet Discovery Tool (BDT). It is highly suggested that Engineering Mode be operated by trained installers only, because it is related to system parameters that will affect the control results.

Operation of Engineering Menu

- At power “ON”, press and hold both the UP and DOWN buttons simultaneously for 5 seconds to enter Engineering Mode menu.

- Press the UP or DOWN buttons to rotate through the menu items. The last item loops back to first item at the end of items in menu. Press the MODE button to enter a submenu item.
- Press the UP or DOWN button to change the setting in the submenu item or hold to speed up setting value change. Press the MODE button to confirm the setting and return to menu item selection. If no button is pressed for 10 seconds, the display will return to the menu item selection. After another 10 seconds, the display will return back to User mode. Settings are not changed unless confirmed using the MODE button.
- To leave Engineering Mode, rotate till (End) menu item appears and press the MODE button. Alternately, pressing no buttons for 10 seconds will return the thermostat back to User mode. Settings are not changed unless confirmed using the MODE button.

Engineering Menu Flow Chart

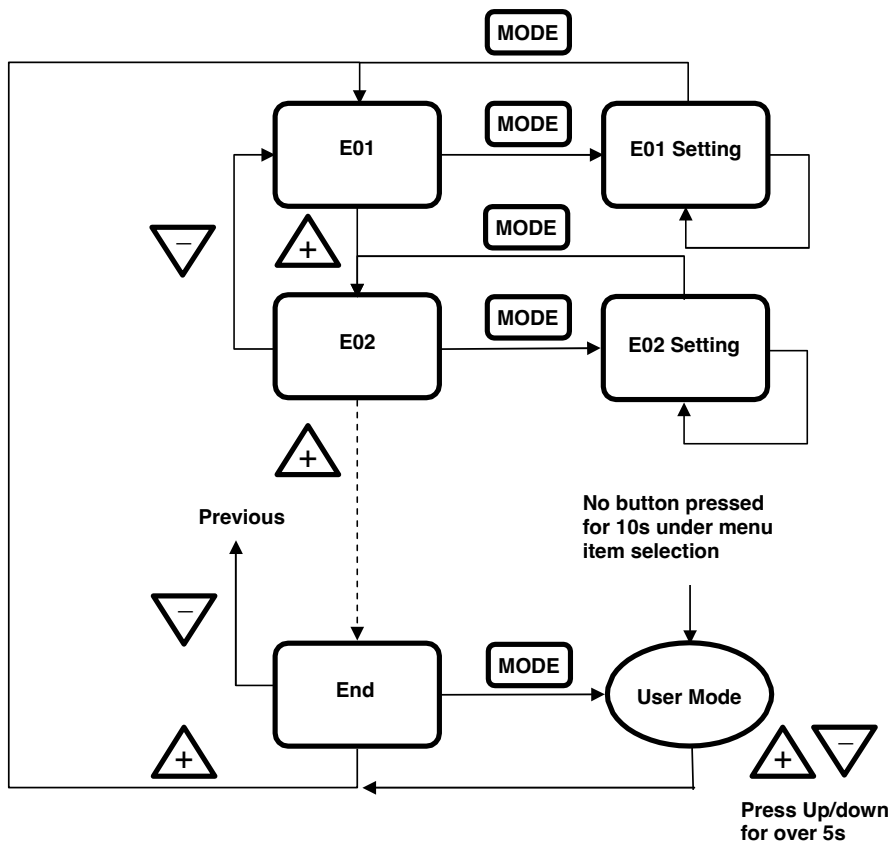

Engineering Menu Items Table

Item	Mnemonic	Description	°C Scale		°F Scale		Step
			Default	Range	Default	Range	
E1	db	Deadband	2.0	0~10	4.0	0~18	0.5 (°C/°F)
E2	ESIC	Unoccupied(ESI) cooling set point	28	25~35	82.5	77~95	1.0 (°C/°F)
E3	ESIH	Unoccupied(ESI) heating set point	15	10.0~22.0	59	50.0~72.0	1.0 (°C/°F)
E4	I-t	Integral Time and Output Cycle Time (seconds)	60	0~500	60	0-500	10 (Sec.)
E5	OPL1	Not used					
E6	SPA1	Not used					
E7	SP-L	Low limit for temperature set point	10	0~50	50	32~122	1.0 (°C/°F)
E8	SP-H	High limit for temperature set point	30	0~50	95	32~122	1.0 (°C/°F)
E9	OFSt	Current temperature offset	0.0	-10.0~10.0	0.0	-18.0~18.0	0.1 (°C/°F)
E10	Pb	Proportional band or stage width	1.5	0~10.0	3.0	0~18.0	0.1 (°C/°F)
E11	diFF	Stage differential	0.5	0.1~1.0	1.0	0.1~1.8	0.1 (°C/°F)
E12	LOC	<p><i>Bit Definition:</i></p> <p>0: MODE button (dec=1)</p> <p>1: Down buttons (dec=2)</p> <p>2: Up button (dec=4)</p> <p>3: FAN SPEED button (dec=8)</p> <p>4: Power On/Off button (dec=16)</p> <p>5: SET (or °C/°F) button (dec=32)</p> <p>6: ESI contact detection (dec=64)</p> <p>7: Door/Window contact detection (dec=128)</p> <p>8: Modification for communication parameters (dec=256) i.e. baud rate, MAC addr, device inst.</p> <p>9: Control DOs by thermostat algorithm (0) or BACnet sup. (1) (dec=512)</p> <p>10~15: reserved/unused</p> <p><i>Bit Value</i></p> <p>0: Unlock / enable</p> <p>1: Lock / disable</p> <p><i>Examples (add dec values to lock multiples)</i></p> <p>Unlock/enable all (0)</p> <p>Lock MODE Button (1)</p> <p>Lock Down Button (2)</p> <p>Lock MODE & Down Buttons (3 = 1+2)</p> <p>Lock Power On/Off button (4)</p> <p>Lock MODE & Power & Down (7 = 1+2+4)</p> <p>Lock SET button (32)</p> <p>Lock MODE & Down & Power & SET (39 = 1+2+4+32)</p> <p>ESI contact disable (64)</p> <p>Lock the modification for communication parameters (256)</p> <p>DOs control commanded by BACnet (512)</p>	64	0-1023	64	0-1023	1

Item	Mnemonic	Description	°C Scale		°F Scale		Step
			Default	Range	Default	Range	
E13	ESI	ESI (DI1) digital sensor contact definition	0	0~1	0	0~1	0: N.O. 1: N.C.
E14	rE-C	Not used					
E15	rE-H	Not used					
E16	rS	Space Temperature Source	0	0~2	0	0~2	0: built-in 1: remote sense 2: assigned through BACnet
E17	-SP-	Display present temperature value of or current set-point for LCD	0	0~1	0	0~1	0: display PV 1: display SP
E18	door	Door or Windows contact definition (not applicable to all models)	0	0~1	0	0~1	0: N.O. 1: N.C.
E19	LFAn	Lowest Fan speed in Auto fan mode	0	0~1	0	0~1	0: stop 1: low
E20	Pct	Output Percentage (not used)	0	0~100	0	0~100	1%
E21	devH	Device instance no. - Hi bytes	100	0~4194	100	0~4194	1
E22	devL	Device instance no. - Low bytes	1	0~999 (if ID-H <=4193) 0~302 (if ID-H = 4194)	1	0~999 (if ID-H <=4193) 0~302 (if ID-H = 4194)	1
E23	UdP	UDP Port Number	47808 (BAC0)	0~65535 (0~FFFF)	47808 (BAC0)	0~65535 (0~FFFF)	1
E24	rHSt	Relative Humidity Offset (221CH models only)	0	-30.0~ 30.0	0	-30.0~30.0	0.1%RH
E25	F-Ht	Fan Output for Heating	0	0/1	0	0/1	0: Disable 1: Enable
E26	dLyC	Cooling Short Cycle Delay	3	1~3	3	1~3	1 (minutes)
E27	cycC	Cooling Maximum Cycles per Hour	4	2~6	4	2~6	1 (cycles/hour)
E28	dLyH	Heating Short Cycle	3	0~3	3	0~3	1 (minutes)
E29	cycH	Heating Maximum Cycles per Hour	4	2~255	4	2~255	1 (cycles/hour)

Item	Mnemonic	Description	°C Scale		°F Scale		Step
			Default	Range	Default	Range	
E30	tyPE	Control Type	2	1~2	2	1~2	0: Cooling Only 1: C&H Manual 2: C&H Auto 3: Heating Only NOTE: Cool only and Heat only types disabled
E31	OPL2	Minimum Output for AO2 <i>(not used)</i>					
E32	SPA2	Span Offset for AO2 <i>(not used)</i>					
E33	Hrtr	Communication Heartbeat Minimum Rate	60	10~3600	60	10~3600	10s
E34	CO2H	CO2 Input High Value <i>(not used)</i>					
E35	C2PB	CO2 Control Output Proportional Band <i>(not used)</i>					
E36	C2SP	CO2 Setpoint <i>(not used)</i>					
E37	C2Lo	CO2 Control Minimum Output <i>(not used)</i>					
E38	AFtH	After Hour Extension Time <i>(not used)</i>					
E39	VALL	Input Low Value of Valve Feedback <i>(not used)</i>					
E40	VALH	Input High Value of Valve Feedback <i>(not used)</i>					
E41	AI-L	Analog Input Low Value <i>(not used)</i>					
E42	AI-H	Analog Input High Value <i>(not used)</i>					
E43	Hrt	Communication Heartbeat Flip-Flop	0	0/1	0	0/1	0: Off 1: On
E44	CSPL	Minimum Cooling Temperature Setpoint	18.0	0.0-50.0	65.0	32.0-122.0	0.1 (°C/°F)
E45	HSPH	Maximum Heating Temperature Setpoint	25.0	0.0-50.0	77.0	32.0-122.0	0.1 (°C/°F)
E46	nFAn	Minimum Fan Output <i>(not used)</i>					
E47	hFAn	Maximum Fan Output <i>(not used)</i>					
E48	FAnL	Low Fan Speed Setting <i>(not used)</i>					
E49	FAn2	Med. Fan Speed Setting <i>(not used)</i>					
E50	FAnH	Hi Fan Speed Setting <i>(not used)</i>					
E51	Run	Modulating Fan Speed Run Type <i>(not used)</i>					
E52	OFFt	Minimum Off Time	180	0~600	180	0~600	5 (seconds)
E53	On-t	Minimum On Time	0	0~600	0	0~600	5 (seconds)
E54	Str	Floating Motor Full Stroke Time <i>(not used)</i>					
E55	Phy1	MAC address 1st & 2nd bytes		hhhh		hhhh	h: 0~F in hex
E56	Phy2	MAC address 3rd & 4th bytes		hhhh		hhhh	h: 0~F in hex

Item	Mnemonic	Description	°C Scale		°F Scale		Step
			Default	Range	Default	Range	
E57	Phy3	MAC address 5th & 6th bytes		hhhh		hhhh	h: 0~F in hex
E58	IP-1	1st byte of IPv4 address	192	0~255	192	0~255	1
E59	IP-2	2nd byte of IPv4 address	168	0~255	168	0~255	1
E60	IP-3	3rd byte of IPv4 address	0	0~255	0	0~255	1
E61	IP-4	4th byte of IPv4 address	1	0~255	1	0~255	1
E62	tEst	Self-Diagnostic – toggle all LCD features and all relays. Use only to test				Use Caution!	Press MODE to engage test
E63	boot	Reset Wi-Fi parameters to factory defaults					Press MODE to reset
E64	rSt	Reset all parameters including communication and control algorithm to the factory defaults				Use Caution!	Press MODE to reset
E65	End	Exit Engineer Mode Menu					Press MODE to exit Engineering Menu

Lock Function Setup and Examples

The 16-bit binary encoded decimal register accessed through Lock [AV17] BACnet object and LOC engineering menu item is used to enable/disable features in the thermostat. The first 10 bits are used (bit 0 ~ bit 9), bits 10~15 are reserved/unused. Bits are represented by their decimal values and are added or subtracted to toggle from “0” to “1”. Add a bit’s decimal value to toggle to “1” or subtract a bit’s decimal value to toggle to “0”. See table below.

Bit Definition:	Decimal Value to Write:	Add decimal values to lock multiples. Bold decimal number is the example value to write to Lock object. Examples:
0: MODE button	(dec=1)	Unlock/enable all (0) – this will also enable ESI DI1 (add 64 to all values below to maintain default occupancy selection over BACnet). Lock MODE button (1) Lock DOWN button (2) Lock MODE & DOWN (3 = 1+2) Lock UP button (4) Lock MODE & DOWN & UP (7 = 1+2+4) Lock FAN SPEED button (8) Lock MODE & DOWN & UP & FAN (15 = 1+2+4+8) Lock POWER button (16) Lock MODE & DOWN & UP & FAN & POWER (31 = 1+2+4+8+16) Lock SET button (32) Lock MODE & DOWN & UP & FAN & POWER & SET (63 = 1+2+4+8+16+32) ESI contact disable (64 – default). When the default value of 64 is maintained, occupancy is set over BACnet and SET user button. Lock MODE & DOWN & UP & FAN & POWER & SET & disable ESI DI1 (127 = 1+2+4+8+16+32+64) Door/Window contact detection (unused) Lock the modification for communication parameters such as baud rate and mac address (256) Lock MODE & DOWN & UP & FAN & POWER & SET & disable ESI DI1 & modification for communication parameters (383 = 1+2+4+8+16+32+64+256) DOs control commanded by BACnet (512)
1: DOWN button	(dec=2)	
2: UP button	(dec=4)	
3: FAN SPEED button	(dec=8)	
4: POWER On/Off button	(dec=16)	
5: SET (or °C/°F) button	(dec=32)	
6: ESI contact detection	(dec=64)	
7: Door/Window contact detection (unused)	(unused)	
8: Modification for communication parameters (i.e., baud rate, MAC addr, device inst.)	(dec=256)	
9: Control DOs by thermostat algorithm (0) or BACnet sup. (1)	(dec=512)	
10~15: reserved/unused	(unused)	
Bit Value:		
0: Unlock / enable		
1: Lock / disable		

4.4 BACnet Objects and Network Configuration

Transmission type

- Physical layer: Wi-Fi 802.11 b/g/n
- Protocol: BACnet/IP
- UDP Port Number: BAC0 (47808)
- MAC address: Wi-Fi chip MAC address found written on the back side of thermostat or in Engineering Menu item (Phy3). This can assist when multiple Wi-Fi thermostats are installed.
- Device Instance: 100001

Initial Configuration

All configuration parameters are settable through use of the buttons on thermostat by entering the Engineer Menu, or once installed on the BACnet network, configuration can also be altered using BACnet commands. Network command-based configuration can also be accomplished on the bench using a Wi-Fi enabled laptop/computer/tablet/smart phone and Contemporary Controls' free [BACnet Discovery Tool](#).

Wi-Fi Communication Configuration

Overview

The BASstat Wi-Fi thermostat is preconfigured with a BACnet Device Instance of 100001 and a UDP Port Number of 47808 (decimal) equivalent to BAC0 (hexadecimal). To alter this configuration, enter the Engineering Menu by holding down the UP and DOWN buttons simultaneously for 5 seconds. Use the UP and DOWN buttons to navigate through the menu and change menu item values. Use the MODE button to enter a menu item and accept/confirm a selected value. To exit the Engineering Menu, navigate to menu item (End) and press MODE, or the menu will exit automatically when not used after 5 seconds.

Addressing

A unique Device Instance Number throughout the entire BACnet internetwork is required to distinguish the device from all other BACnet devices. When more than one BASstat is installed at the same time, their Device Instance Number must be configured prior to connecting to the BACnet/IP network or BACnet communication will fail due to duplicate device instances.

Device instance can be modified in Engineering Menu items (dEVH) – high bytes and (dEVL) – low bytes. Device Instance = (dEVH)*1000+(dEVL). Device Instance example: if (dEVH) is set to 4194 and (dEVL) is set to 7, Device Instance Number = 4194007. Device Instance Number can also be changed by writing to BACnet object [AV21] Device Instance once the thermostat is online. The BACnet UDP Port Number can be configured in Engineering Menu item (UdP).

BACnet/IP Wi-Fi (BW2) model will initially boot up as a Wi-Fi Access Point to allow for IP configuration.

This requires connecting to the thermostat as an access point for initial configuration using a Wi-Fi enabled laptop/computer/tablet/smart phone. Look for the BASstat- 221C-BW2 with its unique SSID of "WiFi-122B-xxxx" and no access point passphrase by default (simply click to connect to Access Point). The digits "xxxx" in "122B-xxxx" are the last 4 digits of the thermostat's Wi-Fi chip MAC address found written on the back side of the Wi-Fi module.

This ensures a unique SSID for discovery and configuration and it can assist in identification of thermostats when multiple Wi-Fi stats are installed on the same site (unique identifier outlined in blue in the image below). This unique identifier can also be viewed in Engineering Menu item (*Phy3*).



Once connected to the thermostat as an access point, open its web page by typing its default address of **192.168.0.1** with **admin** for username and **no password**. Web page pictured below will be presented for IP Network Configuration. The default IP configuration is shown below.

Network Configuration

Device ID: WiFi-122B-1a9f
MAC Address: d0ba-e414-1a9f

Network Mode : Access Point Infrastructure

Device SSID :

Device Passphrase : (None or at least 8 alphanumeric)

Channel : ▼

IP Address :

Network Mask :

Gateway :

As Foreign Device

Save & Restart

After initial connection using laptop or tablet or smart phone, the Wi-Fi mode in the thermostat can be changed to *Infrastructure* mode. The local Wi-Fi router/access point can be selected from the *Available AP* drop-down list, or an *AP SSID* can be entered manually. Enter the *AP Passphrase* to authenticate and connect to the AP.

ATTENTION: Once connected to the Wi-Fi access point, the Wi-Fi thermostat will use the Wi-Fi access point credentials. To ensure a secure connection, when setting up the Wi-Fi router (Access Point) the thermostats will be connected to, make sure you set up a strong access point passphrase (password) and encryption method! This is required for Wi-Fi client devices to connect to the Wi-Fi router securely and it is essential to cyber security. Creating a good Wi-Fi password is the first step in creating a secure environment that is inaccessible to unauthorized parties. Use the following tips when creating a Wi-Fi access point passphrase:

- Passphrase should be a minimum of eight characters (maximum 15 characters), the more random the better. Use a mix of letters (uppercase and lowercase), numbers, and symbols.
- Do not reuse or repeat passwords across router installations or job sites.
- Change WiFi password regularly (not required but very secure). Provides guidelines for building maintenance personnel.
- Disable broadcast of SSID. This is a very simple setting which stops the broadcast of the access point SSID, and only authorized parties who know the SSID can connect to it. This is configured in the Wi-Fi router.
- Store passwords in a safe place, limit access to authorized parties only, and provide instructions for password reset and reconfiguring a strong password in cases of reconfiguring the network in the future.

Choose an option for DHCP addressing using the radio buttons.

Network Configuration

Device ID: WiFi-122B-1a9f
MAC Address: d0ba-e414-1a9f

Network Mode : Access Point Infrastructure

Available AP :

AP SSID

AP Passphrase (None or at least 8 alphanumeric)

DHCP : Enable Disable

Save & Restart

The thermostat supports DHCP addressing and will acquire an IP address from the router/access point automatically if you chose *Enable* next to DHCP. If you chose *Disable*, you must assign an *IP Address*, *Network Mask*, and *Gateway Address* within the Wi-Fi router IP subnet manually.

Network Configuration

Device ID: WiFi-122B-1a9f
MAC Address: d0ba-e414-1a9f

Network Mode : Access Point Infrastructure

Available AP : ▼

AP SSID

AP Passphrase (None or at least 8 alphanumeric)

DHCP : Enable Disable

IP Address :

Network Mask :

Gateway :

A reboot of the thermostat is required for new IP configuration to take effect. Click the *Save & Restart* button to reboot the thermostat, and you will be prompted to confirm the restart. Click *OK* to Save New Settings and Restart or click *Cancel* to revisit IP configuration.

192.168.0.1 says

Save New Settings and Restart WiFi Module?

When *OK* is clicked, a confirmation is displayed to indicate configuration is stored in the thermostat's EEPROM. After reboot, the new thermostat credentials will be *admin* for username and the newly configured Access Point's password for password.

192.168.0.1 says

Save Config Done!

Click OK on the confirmation message and wait 20 seconds for the reboot process to complete.

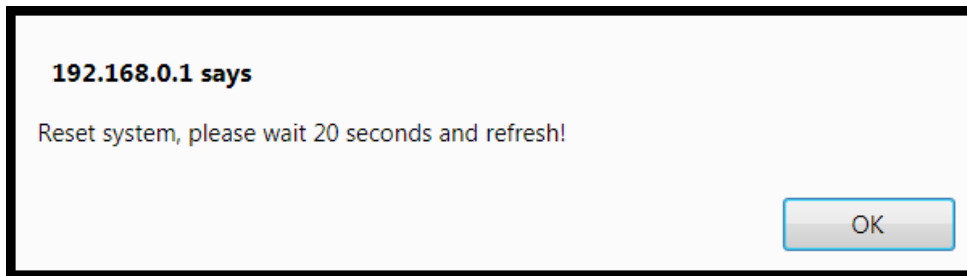

While rebooting, the thermostat will display “DP” icon in the lower right corner to indicate it is in the process of searching and connecting to the AP. Once the “DP” stops flashing, the thermostat has successfully connected to Wi-Fi access point. After reboot of the thermostat, the new *Infrastructure* mode with new IP settings will be used. The thermostat will now be connected to the local Wi-Fi network AP selected in configuration screen and will not show up as an access point itself any more. If you are unsure of the thermostat’s IP address, it could be viewed through the Engineering Menu in items (*IP-1*) for the first octet, (*IP-2*) for the second octet, (*IP-3*) for the third, and (*IP-4*) for the fourth octet of the IP address, or if you have access to the Wi-Fi access point, its “statistics” or “connected devices” web page will show the BASstat BW2’s IP address as well as MAC address (the same address in Engineering Menu items *Phy1*, *Phy2*, and *Phy3* and the printed MAC on the back of the thermostat Wi-Fi module (outlined in blue above).

Reset Settings

The BASstat will store configuration in the event of power loss. If configuration fails or the thermostat needs to be configured to use a different Wi-Fi access point, the thermostat must be reset and reconfigured. There are 2 reset settings options for the Wi-Fi thermostat:

- Boot will restore Wi-Fi communication parameters to default, but it will maintain control algorithm settings. Select (boot) Engineering Menu item and press MODE to confirm.
- Reset will restore all values to default and can be selected from Engineering Menu (rSt).

Foreign Device Registration (FDR)

Communication across IP subnets requires a Broadcast Management Device (BBMD) device or support for Foreign Device Registration (FDR) feature. The BASstat supports the FDR feature to register with a remote BBMD which could be a BACnet client or a BMS headend. To communicate with BACnet clients across subnets, the BAST-221C/CH-BW2 can do FDR registration with a remote BBMD. The BACnet BBMD feature requires a BACnet device with BBMD capability, such as a BACnet router or other, to be installed and configured on the network. BBMD allows discovery of all BACnet/IP devices in the IP subnet instead of just the FDR device.

- Select As Foreign Device.
- The BBMD IP is the address of the BBMD device on the remote network. Enter the address of the BBMD with which the BAST-221C/CH-BW2 will perform Foreign Device Registration (FDR) if there is no local BBMD device in the same subnet as the BAST-21C/CH-BW2 providing communication to the remote subnet.
- Enter the UDP port for BBMD.
- Time to Live is the BBMD registration time. Specify the seconds between successive FDR registrations. Recommended value is 100.

Network Configuration

Device ID: WiFi-122B-1a9f
MAC Address: d0ba-e414-1a9f

Network Mode : Access Point Infrastructure

Device SSID :

Device Passphrase : (None or at least 8 alphanumeric)

Channel :

IP Address :

Network Mask :

Gateway :

As Foreign Device

BBMD IP :

BBMD Port :

Time To Live :

Save & Restart

A reboot of the thermostat is required for new IP configuration to take effect. Click the Save & Restart button to reboot the thermostat, and you will be prompted to confirm the restart. Click OK to Save New Settings and Restart or click Cancel to revisit IP configuration.

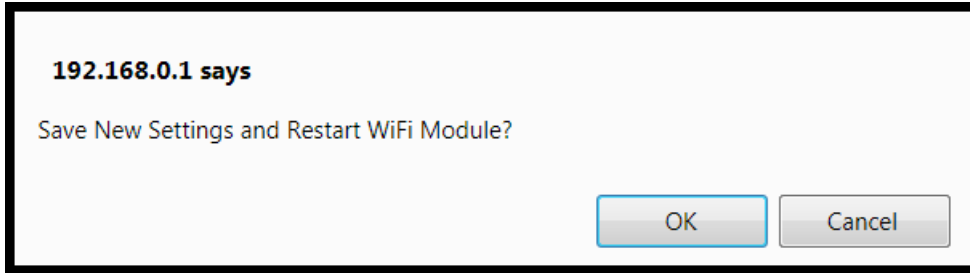

When *OK* is clicked, a confirmation is displayed to indicate configuration is stored in the thermostat's EEPROM. After reboot, the new thermostat credentials will be *admin* for username and the newly configured Access Point's password for password.

Click *OK* on the confirmation message and wait 20 seconds for the reboot process to complete.

BACnet Object Table - Wi-Fi Model (BACnet/IP)

Object name	Type & Instance	Object Property (Readable/Writable)	Range
BACnet Thermostat	Device 100001	Model Name (R)	
		Application Software Version (R)	
		Object Identifier (R)	
		Object Name (R/W)	32 characters (max.)

Object name	Type & Instance	Readable/ Writable	Description	Range and Definition
Current Temperature	AI 0	R	Current Temperature	-999~9999: -99.9~999.9 °C/°F
Active Temperature Setpoint	AI 1	R	Active Temperature Set-Point	°C :0~500 (0.0~50.0°C) °F : 320~1220 (32.0~122.0°F)
Built-in Temperature Sensor	AI 2	R	Built-in Temperature Sensor Reading	-999~9999:-99.9~999.9 °C/°F
Remote Temperature Sensor	AI 3	R	Remote Temperature Sensor Reading	-999~9999:-99.9~999.9 °C/°F
Current Humidity	AI 4	R	Current Humidity (221CH models only)	0~1000: 0.0~100.0%RH

Object name	Type & Instance	Readable/Writable	Description	Range and Definition
Current Dew Point	AI 5	R	Current Dew Point (221CH models only)	-999~9999: -99.9~999.9 °C/°F
Current CO ₂ Reading	AI 6	R	Current CO ₂ Reading	0~3000: 0~3000 ppm
Control Valve Feedback	AI 7	R	Control Valve Feedback	0~1000 (0.0%~100.0%)
Modulating/ Floating Output 1	AI 8	R	Modulating/ Floating Output 1	0~100: 0~100 %
Modulating/ Floating Output 2	AI 9	R	Modulating/ Floating Output 2	0~100: 0~100 %
Modulating Fan Output	AI 10	R	Modulating Fan Output	0~100: 0~100 %
CO ₂ Control Output Percentage	AI 11	R	CO ₂ Control Output Percentage	0~100: 0~100 %
Voltage Input Value	AI 12	R	Voltage Input Value	0~150 (0.0~15.0 VDC)
AI 1 Percentage	AI 13	R	Analog Input 1 Percentage Value	0~1000 (0.0%~100.0%)
AI 2 Percentage	AI 14	R	Analog Input 2 Percentage Value	0~1000 (0.0%~100.0%)
AI 3 Percentage	AI 15	R	Analog Input 3 Percentage Value	0~1000 (0.0%~100.0%)
Cooling Temperature Setpoint	AV 0	R/W	Cooling Temperature Set Point	°C :0~500 (0.0~50.0°C) °F: 320~1220 (32.0~122.0°F)
Space Temperature Via BACnet	AV 1	R/W	BACnet Assigned Current Temperature	-999~9999 (-99.9~999.9°C/°F)
Timer Off	AV 2	R/W	Timer Off (Only for Models with Countdown Timer Function Available).	0~24: 0~24 Hours Count Down 0: Disable
Heating Temperature Setpoint	AV 3	R/W	Heating Temperature Set Point	-999~9999: -99.9~999.9 °C/°F
Hr-Running Time	AV 4	R/W	Running Time of Valve (Hr.)	0~65535 (Hr.) For Reading But 0~30000 (Hr.) For Writing.
M-Running Time	AV 5	R/W	Running Time of Valve (M.)	0~59 (Minute)
Sec-Running Time	AV 6	R/W	Running Time of Valve (Sec.)	0~59 (Sec.)
Deadband	AV 7	R/W	Deadband	°C: 0~100 (0.0~10.0 °C) °F: 0~180 (0.0~18.0 °F)
Unoccupied Cool Setpoint	AV 8	R/W	Unoccupied Cooling Setpoint	°C: 250~300 (25.0~30.0°C) °F: 770~860 (77.0~86.0°F)
Unoccupied Heat Setpoint	AV 9	R/W	Unoccupied Heating Setpoint	°C: 100~220 (10.0~22.0°C) °F: 500~715(50.0~71.5°F)

Object name	Type & Instance	Readable/Writable	Description	Range and Definition
Integral-Cycle Time	AV 10	R/W	Integral Time and Output Cycle Time	0~500 (Sec.)
Analog Minimum Output for AO1	AV 11	R/W	Minimum Output Voltage in Digital Value When Reach Low Limit for AO1	0~125 (LSB)
Span Offset for AO1	AV 12	R/W	Span Offset for AO1	-55~0 (LSB)
Low Setpoint Limit	AV 13	R/W	Low Limit for Set-Point Temperature	°C :0~500 (0.0~50.0°C) °F: 320~1220(32.0~122.0°F)
High Setpoint Limit	AV 14	R/W	High Limit for Set-Point Temperature	°C :0~500 (0.0~50.0°C) °F: 320~1220(32.0~122.0°F)
Temperature Offset	AV 15	R/W	Offset for Current	°C: -100~100 (- 10.0~10.0°C) °F: -180~180 (-18.0~18.0°F)
Proportional Band-Stage Width	AV 16	R/W	Proportional Band or Stage Width	°C :0~100 (00~10.0 °C) °F: 0~180 (00~18.0 °F)
Stage Differential	AV 17	R/W	Stage Differential	°C :1~10 (0.1~1.0 °C) °F: 1~18 (0.1~1.8 °F)
Lock	AV 18	RW	LOCK	<p><i>Bit Definition:</i></p> <ul style="list-style-type: none"> 0: MODE button (dec=1) 1: Down button (dec=2) 2: Up button (dec=4) 3: FAN SPEED button (dec=8) 4: Power On/Off button (dec=16) 5: SET (or °C/°F) button (dec=32) 6: ESI contact detection (dec=64) 7: Door/Window contact detection(dec=128) 8: Modification for communication parameters (dec=256) i.e. baud rate, MAC addr, device inst. 9: Control DOs by thermostat algorithm (0) or BACnet sup. (1) (dec=512) 10~15: reserved/unused <p><i>Bit Value</i></p> <ul style="list-style-type: none"> 0: Unlock / enable 1: Lock / disable <p><i>Examples (add dec values to lock multiples) For more details see Lock Function Setup and Examples section of this manual</i></p>

Object name	Type & Instance	Readable/Writable	Description	Range and Definition
Modulating/floating Control Out Percentage	AV 19	R/W	Percentage of Modulating/Floating Control Output	0~100 (0%~100%)
Device Instance	AV 20	R/W	Device Instance	0~4194302 (NOTE: Changing this value needs to unlock modification for communication parameters in advance. i.e., AV17=0~255 or 512~768. Please refer to LOCK(AV17) for details)
UDP Port No	AV 21	R/W	UDP Port Number	0~65535
Humidity Offset	AV 22	R/W	Humidity Offset Value (221CH models only)	-300~300 (-30.0~30.0 %RH)
Cooling Short Cycle Delay	AV 23	R/W	Cooling Short Cycle Delay	1~3 Minutes
Cooling Maximum Cycles per Hour	AV 24	R/W	Cooling Maximum Cycles per Hour	2~6 Cycles
Heating Short Cycle	AV 25	R/W	Heating Short Cycle Delay	0~3 Minutes
Heating Maximum Cycles per Hour	AV 26	R/W	Heating Maximum Cycles per Hour	2~8 Cycles
Analog Minimum Output for AO2	AV 27	R/W	Minimum Output Voltage in Digital Value When Reach Low Limit for AO2	0~125 (LSB)
Span Offset for AO2	AV 28	R/W	Span Offset for AO2	-55~0 (LSB)
Heartbeat Rate	AV 29	R/W	Communication Heartbeat Minimum Rate	10~3600 s
CO2 Input High	AV 30	R/W	CO2 Input High Value	1000~3000 ppm
CO2 Control Out Proportional Band	AV 31	R/W	CO2 Control Output Proportional Band	100~2000 ppm
CO2 Setpoint	AV 32	R/W	CO2 Setpoint	600~1000 ppm
CO2 Control Minimum Out Percentage	AV 33	R/W	CO2 Control Minimum Output Percentage	0~20%
After Hour Extension Run Time	AV 34	R/W	After Hour Extension Run Time	5~20(0.5~2.0) Hour
Control Valve Feedback Input Low	AV 35	R/W	Input Low Value of Control Valve Feedback	0~1000 (0.0~100.0 %)
Control Valve Feedback Input High	AV 36	R/W	Input High Value of Control Valve Feedback	0~1000 (0.0~100.0 %)
Analog Input Low	AV 37	R/W	Analog Input Low Value	0~1000 (0.0~100.0 %)
Analog Input High	AV 38	R/W	Analog Input High Value	0~1000 (0.0~100.0 %)

Object name	Type & Instance	Readable/ Writable	Description	Range and Definition
Minimum Cooling Temperature	AV 39	R/W	Minimum Cooling Temperature Setpoint	°C:0~500 (0.0~50.0°C) °F: 320~1220 (32.0~122.0°F)
Maximum Heating Temperature Setpoint	AV 40	R/W	Maximum Heating Temperature Setpoint	°C:0~500 (0.0~50.0°C) °F: 320~1220
Minimum Fan Output	AV 41	R/W	Minimum Fan Output at Auto Fan Mode (for Modulating Fan Application)	0%~Reg 51
Maximum Fan Output	AV 42	R/W	Maximum Fan Output at Auto Fan Mode (for Modulating Fan Application)	Reg 50~100%
Low Fan Speed Setting	AV 43	R/W	Low Fan Speed Setting (for Modulating Fan Application)	0%~Reg 53
Med. Fan Speed Setting	AV 44	R/W	Med. Fan Speed Setting (for Modulating Fan Application)	Reg 52~Reg54
Hi Fan Speed Setting	AV 45	R/W	Hi Fan Speed Setting(For Modulating Fan Application)	Reg 53~100%
Minimum Off Time	AV 46	R/W	Minimum Off Time	0~600 seconds
Minimum On Time	AV 47	R/W	Minimum On Time	0~600 seconds
Stroke Time	AV 48	R/W	Stroke time	10~1600 sec.
Set Point for Humidity	AV 49	R/W	Set Point for Humidity Control	0~1000 (0.0~100.0 %RH)
Dew Point Set Point	AV 50	R/W	Dew Point Temperature Set Point	-999~9999: -99.9~999.9 °C/°F
Occupancy Status	BI 0	R	Status of Occupancy	0: Room Occupied 1: Room Unoccupied
Window-Door Status	BI 1	R	Window/ Door Status	0: Door/Window Closed 1: Door/Window Open
Cooling-heating Status	BI 2	R	Status of Cooling/Heating Control Output	0: Close & Off 1: Open & On
Relay 1 Status	BI 3	R	Status of Relay 1 (Cooling Stage 1)	0: Off, 1: On
Relay 2 Status	BI 4	R	Status of Relay 2 (Cooling Stage 2)	0: Off, 1: On
Relay 3 Status	BI 5	R	Status of Relay 3 (Heating Stage 1)	0: Off, 1: On
Relay 4 Status	BI 6	R	Status of Relay 4 (Heating Stage 2)	0: Off, 1: On
Relay 5 Status	BI 7	R	Status of Relay 5	0: Off, 1: On
Relay 6 Status	BI 8	R	Status of Relay 6	0: Off, 1: On

Object name	Type & Instance	Readable/Writable	Description	Range and Definition
Relay 7 Status	BI 9	R	Status of Relay 7 Fan	0: Off, 1: On
DI 1 Status	BI10	R	Status of Digital Input 1	0: Off, 1: On
DI 2 Status	BI11	R	Status of Digital Input 2	0: Off, 1: On
DI 3 Status	BI12	R	Status of Digital Input 3	0: Off, 1: On
DI 4 Status	BI13	R	Status of Digital Input 4	0: Off, 1: On
DI 5 Status	BI14	R	Status of Digital Input 5	0: Off, 1: On
DI 6 Status	BI15	R	Status of Digital Input 6	0: Off, 1: On
DI 7 Status	BI16	R	Status of Digital Input 7	0: Off, 1: On
Fan Status	BI17	R	Fan Status	0: Off, 1: On
Flow Switch Status	BI18	R	Differential Pressure (Air Flow) Switch Status	0: Off, 1: On
Trip Status	BI19	R	Trip Alarm Status	0: Off, 1: On
Filter Status	BI20	R	Filter Dirty Alarm Status	0: Off, 1: On
Smoke/ Fire Alarm Status	BI21	R	Smoke/ Fire Alarm Status	0: Off, 1: On
Local/ Remote Switch Status	BI22	R	Local/ Remote Switch Status	0: Off, 1: On
Disconnect Switch Status	BI23	R	Disconnect Switch Status	0: Off, 1: On
Maintenance Switch Status	BI24	R	Maintenance Switch Status	0: Off, 1: On
Frozen Alarm Status	BI25	R	Frozen Alarm Status	0: Off, 1: On
After Hour Status	BI26	R	After Hour Status	0: Normal Hour 1: After Hour
Occupancy Contact Definition	BV 0	R/W	Occupancy(DI1) Contact Definition (this feature is model specific)	0: N.O. 1: N.C.
Cooling Direct-Reverse Acting	BV 1	R/W	Modulating Cooling Direct/Reverse Signal Output	0: Direct (0 To10v) 1: Reverse (10 To 0V)
Heating Direct-Reverse Acting	BV 2	R/W	Modulating Heating Direct/Reverse Signal Output	0: Direct (0 To10v) 1: Reverse (10 To 0V)
Fan Runs at Set 3 Speeds or Free Speed at Auto Fan Mode(For Modulating Fan)	BV 3	R/W	Fan Runs at Set 3 Speeds or Free Speed between Min and Max Fan Output at Auto Fan Mode(For Modulating Fan Application)	0(Free Speed) ~1(3 Speeds)
Window-Door Contact Definition	BV 4	R/W	Door or Windows(DI2) Contact Definition	0: N.O. 1: N.C.

Object name	Type & Instance	Readable/Writable	Description	Range and Definition
On-Off Control	BV 5	R/W	On/Off Status of Thermostat	0: Off, 1: On
Temperature Scale	BV 6	R/W	°C/ °F	0: °C 1: °F
Relay 1 Control	BV7	R/W	On/Off Control of Relay 1 (Cooling Stage 1)	0: Off, 1: On
Relay 2 Control	BV8	R/W	On/Off Control of Relay 2 (Cooling Stage 2)	0: Off, 1: On
Relay 3 Control	BV9	R/W	On/Off Control of Relay 3 (Heating Stage 1)	0: Off, 1: On
Relay 4 Control	BV10	R/W	On/Off Control of Relay 4 (Heating Stage 2)	0: Off, 1: On
Relay 5 Control	BV11	R/W	On/Off Control of Relay 5	0: Off, 1: On
Relay 6 Control	BV12	R/W	On/Off Control of Relay 6	0: Off, 1: On
Relay 7 Control	BV13	R/W	On/Off Control of Relay 7 Fan	0: Off, 1: On
Occupancy Command	BV 14	R/W	Room Occupancy Setting	0: Occupied, 1: Unoccupied
Fan Output for Heating	BV15	R/W	Disable/ Enable Fan Output for Heating	0: Disable 1: Enable
Heartbeat signal	BV16	R/W	Heartbeat Pulse Signal	0: Off 1: On
Fan Mode	MSV 0	R/W	Fan Mode	1: Auto 1: Low 3: Med.4: Hi
System Mode	MSV 1	R/W	Working Mode: Heat, Cool or Ventilation	1: Cool Mode 2: Heat Mode 3: Ventilation @ Cool Mode 4: Ventilation @ Heat Mode
Sleep	MSV 2	R/W	Sleep (Only for Models with Sleep Function Available).	1: Disable, 2: 0 Hr. Sleep 3: 0.5 Hr. Sleep 4: 1 Hr. Sleep 5: 1.5 Hrs. Sleep, 6: 2 Hrs. Sleep
Temperature Source	MSV3	R/W	Current Temperature Source	1: Built-In Temp. Sensor 2: Remote Temp. Sensor 3: Assigned through BACnet
Lowest Fan Speed	MSV 4	R/W	Lowest Fan speed in Auto Fan mode	1: Stop 2: Low 3: Med. 4: Hi
Fan Speed Status	MSV 5	R	Fan Speed Status	1: Stop 2: Low 3: Med 4: Hi

Object name	Type & Instance	Readable/Writable	Description	Range and Definition
Display Options	MSV 6	R/W	LCD Display Options	1: T & Time (if available) 2: SP & Time (if available) 3: T & CO2 (if available) 4: CO2 & Time (if available) 5: SP & CO2 (if available) 6: T & RH (if available) 7: T & Valve (if available)
Control Type	MSV 7	R/W	Control Type Selection	1: Cooling Only 2: Cooling or Heating Manual Changeover 3: Cooling and Heating Auto Changeover (default) 4: Heating Only NOTE: Cool only and Heat only types disabled

5 Warranty

Contemporary Controls (CC) warrants this product to the original purchaser for two years from the product shipping date. Product returned to CC for repair is warranted for one year from the date the repaired product is shipped back to the purchaser or for the remainder of the original warranty period, whichever is longer.

If the product fails to operate in compliance with its specification during the warranty period, CC will, at its option, repair or replace the product at no charge. The customer is, however, responsible for shipping the product; CC assumes no responsibility for the product until it is received.

CC's limited warranty covers products only as delivered and does not cover repair of products that have been damaged by abuse, accident, disaster, misuse, or incorrect installation. User modification may void the warranty if the product is damaged by the modification, in which case this warranty does not cover repair or replacement.

This warranty in no way warrants suitability of the product for any specific application. IN NO EVENT WILL CC BE LIABLE FOR ANY DAMAGES INCLUDING LOST PROFITS, LOST SAVINGS, OR OTHER INCIDENTAL OR CONSEQUENTIAL DAMAGES ARISING OUT OF THE USE OR INABILITY TO USE THE PRODUCT EVEN IF CC HAS BEEN ADVISED OF THE POSSIBILITY OF SUCH DAMAGES, OR FOR ANY CLAIM BY ANY PARTY OTHER THAN THE PURCHASER.

THE ABOVE WARRANTY IS IN LIEU OF ANY AND ALL OTHER WARRANTIES, EXPRESSED OR IMPLIED OR STATUTORY, INCLUDING THE WARRANTIES OF MERCHANTABILITY, FITNESS FOR PARTICULAR PURPOSE OR USE, TITLE AND NONINFRINGEMENT.

6 Returning Products for Repair

Return the product to the location where it was purchased by following the instructions at the URL:

www.ccontrols.com/rma.htm

7 Declaration of Conformity

Additional compliance documentation can be found on our website: www.ccontrols.com



United States
Contemporary Control
Systems, Inc.

Tel: +1-630-963-7070
Fax: +1-630-963-0109

info@ccontrols.com

China
Contemporary Controls
(Suzhou) Co. Ltd

Tel: +86 512 68095866
Fax: +86 512 68093760

info@ccontrols.com.cn

United Kingdom
Contemporary Controls
Ltd

Tel: +44 (0)24 7641 3786
Fax: +44 (0)24 7641 3923

ccl.info@ccontrols.com

Germany
Contemporary Controls
GmbH

Tel: +49 341 520359 0
Fax: +49 341 520359 16

ccg.info@ccontrols.com

www.ccontrols.com

CONTEMPORARY CONTROLS®