

BAST-321HP-B2

BACnet Communicating Thermostat for 2-stage Heat Pump Operation

BASstat

Heat Pump Thermostat User Manual



UM-15094000-AA0

CONTEMPORARY CONTROLS®

Trademarks

BASautomation, Contemporary Controls, and CTRLink are registered trademarks of Contemporary Control Systems, Inc. BACnet is a registered trademark of the American Society of Heating, Refrigerating and Air-Conditioning Engineers, Inc. Powered by Sedona Framework is a trademark of Tridium, Inc. Other product names may be trademarks or registered trademarks of their respective companies.

Copyright

© Copyright 2021, by Contemporary Control Systems, Inc. All rights reserved. No part of this publication may be reproduced, transmitted, transcribed, stored in a retrieval system, or translated into any language or computer language, in any form or by any means, electronic, mechanical, magnetic, optical, chemical, manual, or otherwise, without the prior written permission of:

Contemporary Control Systems, Inc.
2431 Curtiss Street
Downers Grove, Illinois 60515 USA

Tel: +1-630-963-7070
Fax: +1-630-963-0109
E-mail: info@ccontrols.com

Disclaimer

Contemporary Control Systems, Inc. reserves the right to make changes in the specifications of the product described within this manual at any time without notice and without obligation of Contemporary Control Systems, Inc. to notify any person of such revision or change.

Contents

- 1 Introduction..... 3
 - 1.1 Features and Benefits..... 4
 - 1.2 Product Image and Main Features 5
 - BASstat 321C-B2 5
- 2 Specifications 6
 - 2.1 Inputs 6
 - 2.2 Outputs 6
 - 2.3 Communication..... 6
 - 2.4 Electrical 6
 - 2.5 Environmental..... 7
 - 2.6 Electromagnetic Compatibility..... 7
 - 2.7 Mechanical (all dimensions are in mm)..... 8
- 3 Installation 9
 - 3.1 Terminal Block Pin Assignments 9
 - 3.2 Limited Power Source..... 9
 - 3.3 Power Supply Precautions..... 10
 - 3.4 Wiring Diagram 10
- 4 Operation..... 11
 - 4.1 User Mode 11
 - 4.2 Control Type 13
 - 4.3 Engineering Mode Menu..... 17
 - 4.4 BACnet Objects and Network Configuration 23
- 5 Warranty 31
- 6 Returning Products for Repair 31
- 7 Declaration of Conformity 32

1 Introduction

The BAST-321HP-B2 is a member of the BASstat BACnet Communicating Thermostat series. It provides multi-staged heating and cooling control in an attractive wall-mounted enclosure with a large LCD display. Intended for use with single and multiple stage heat pump units, the thermostat can control 2 reversible DX heat pump compressors, one binary reversing valve, one binary supply fan relay, plus one binary stage of auxiliary heating (gas or electric). This BASstat is BTL listed to ensure seamless integration into a BACnet network, using BACnet/MSTP over 2-wire EIA-485, and can be routed to BACnet/IP clients using a Contemporary Controls BASrouter (BASRT-B). A large, easy to read LCD display indicates setpoint, space temperature and current mode of operation using graphical icons.

The BASstat has a built-in space temperature sensor with provision for remote wired 3k Ω NTC thermistor sensor or temperature value can be sent by another communicating device over the BACnet network. The BASstat is configurable locally using the *Engineering Menu* or via a network connection to a BACnet client. Contemporary Controls' free [BACnet Discovery Tool](#) can be used for initial discovery and configuration of the thermostat over the network. Control algorithm parameters such as deadband, proportional gain, integral rate and trip points are all configurable. This BASstat also features configurable fan control and occupancy selection. Operating states are indicated on the thermostat display.

The numerous features available in the BASstat can be configured by the systems integrator to meet user requirements in two different ways. One way is using a button sequence on the thermostat in order to enter the *Engineering Menu* - which requires physical access to the thermostat. Optionally, the buttons could be locked to limit user access to *Engineering Menu* after installation is complete. The second method is configuring the thermostat over the BACnet network using a BACnet client device or software such as Contemporary Controls' free [BACnet Discovery Tool \(BDT\)](#).

1.1 Features and Benefits

- Stand-alone thermostat algorithm or fully BACnet network-controllable
- BTL listed with B-ASC device profile for integration into BACnet networks
- 24VAC (+/-10%) power input
- BACnet communication -BACnet MS/TP with baud rate selections up to 76.8kbps
- Suitable for single or dual compressor heat pump control applications with manual or automatic changeover
- Adjustable algorithm applied to multiple stage control (2 cooling stages- 3 heating stages)
- Effective run time accumulation for energy consumption metering
- Configurable control parameters such as deadband, proportional gain, integral rate and cycle time
- Adjustable minimum/maximum set point ranges
- Three options for temperature sensing:
 - Built-in temperature sensor, or
 - Remote sensor (RS) input for wiring in a remote temperature sensor (NTC 3k Ω), or
 - BACnet network temperature input
- Occupancy status can be switched (1) locally by the user, (2) by using a separate occupancy sensor, or (3) by using BACnet network command.
- Separate adjustable occupied and unoccupied set points for heating and cooling mode
- Fan can be set to run continuously or automatically
- Non-volatile memory retains user settings during power outage
- Thermostat buttons are lockable to prevent tampering
- °C or °F display
- Energy Savings Input for local occupancy control
- Control outputs disabled during "OFF" state for safety

1.2 Product Image and Main Features

BASstat 321C-B2

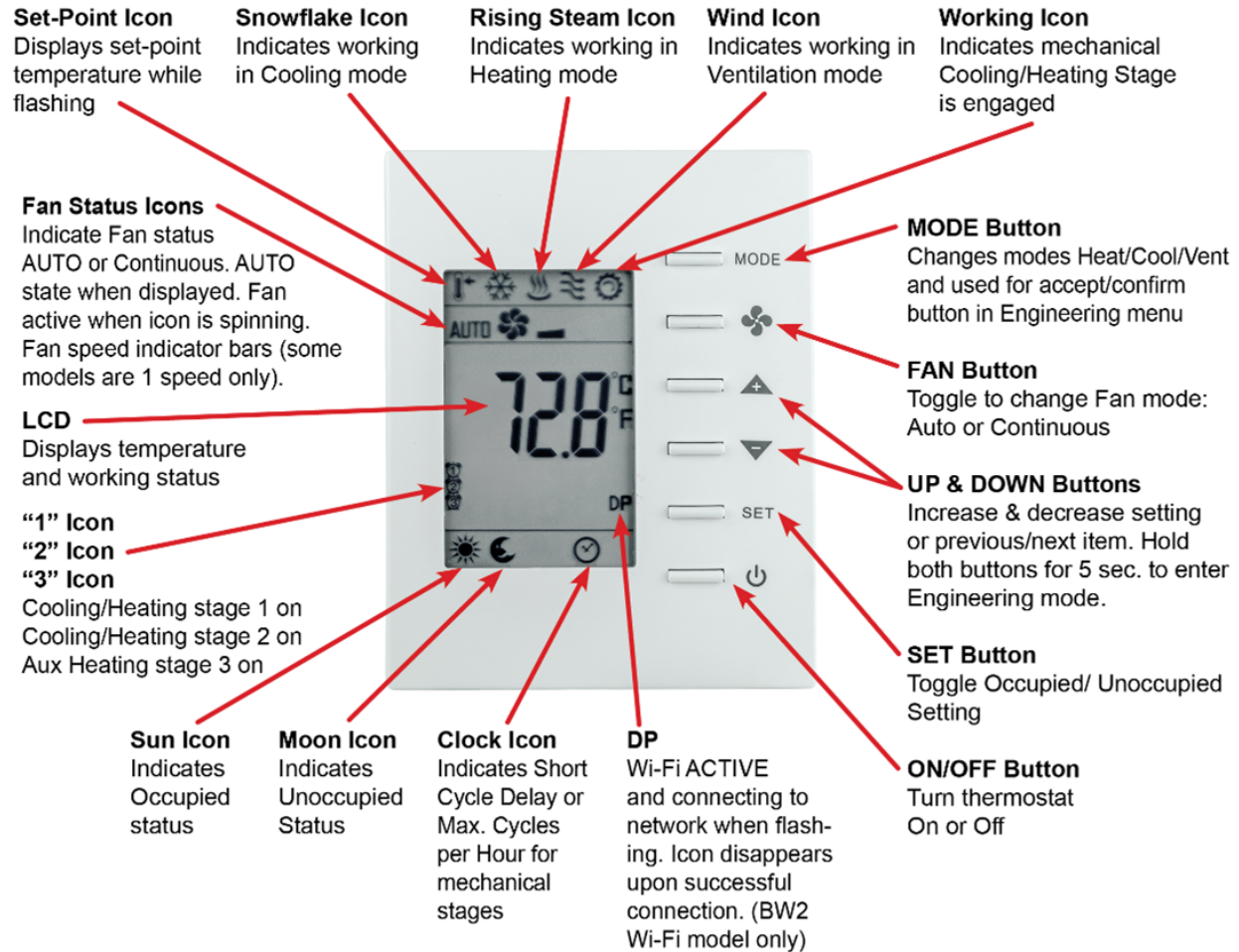

2 Specifications

2.1 Inputs

Item	Description
Temperature Display Range	14 to 140°F (-10 to 60°C)
Temperature Display Resolution	0.1°F (0.1°C)
Temperature Accuracy	±1.8°F (±1.0°C) with all outputs off
Energy Savings Input	Provision for external occupancy sensor
Setpoint Range	32-122°F (0-60°C) in 0.5° (°F or °C) increments
Remote Temperature Sensor	Provision for NTC Type 3kΩ thermistor

2.2 Outputs

Item	Description
Relay Output	Fan, Compressor 1, Compressor 2, O/B Reversing Valve, Auxiliary Heat (stage 3)
Contact Rating	SPST 2A at 30 VAC with inductive load
Minimum contact life	100,000 cycles

2.3 Communication

Item	Description
Protocol Compliance	BACnet MS/TP or BACnet/IP with B-ASC, BTL Listed
Physical Layer	EIA-485 2-wire
Baud Rate	9.6, 19.2, 38.4, 76.8 kbps (default 38.4 kbps), N81 format
Cabling	Shielded single-pair twisted 24 ga AWG

2.4 Electrical

Item	Description
Supply Voltage and Current	24 VAC (±10%) 5 VA
Power Source Class	NFPA 70 (NEC) Article 725 Part III Class 2
Internal Power Supply	Half-wave rectified and filtered DC

2.5 Environmental

Item	Description
Operating Temperature	32°F to 122°F (0 to 50°C)
Storage Temperature	14°F to +140°F (-10°C to 60°C)
Relative Humidity	5 to 95% non-condensing

2.6 Electromagnetic Compatibility

The BAST-321HP-B2 complies with the following specifications and bears the CE mark in accordance with the provisions of the Electromagnetic Compatibility (EMC) Directive 2004/108/EC based on the following specifications:

Standard	Test Method	Description
EN 61000-6-2	IEC 61000-4-2	Electrostatic Discharge Immunity
EN 61000-6-2	IEC 61000-4-3	Radiated, Radio-Frequency, Electromagnetic Field Immunity
EN 61000-6-2	IEC 61000-4-4	Electrical Fast Transit/Burst Immunity
EN 61000-6-2	IEC 61000-4-5	Voltage Surge Immunity
EN 61000-6-2	IEC 61000-4-6	Immunity to Conducted Disturbances
EN 61000-6-2	IEC 61000-4-8	Power Frequency Magnetic Field Immunity
EN 61000-6-2	IEC 61000-4-11	Voltage Dips and Interruptions
EN 61000-6-3	IEC 61000-3-2	Limits for Harmonic Current Emissions
EN 61000-6-3	IEC 61000-3-3	Limitation of Voltage Fluctuations and Flicker in Low Voltage Supply Systems

2.7 Mechanical (all dimensions are in mm)

Mounts directly onto wall, panel, standard 65×65mm junction box (hole pitch 60 mm) or standard 2×4-inch vertical junction box (hole pitch 83.5mm).

Width: 94mm
 Height: 118mm
 Depth: 34mm

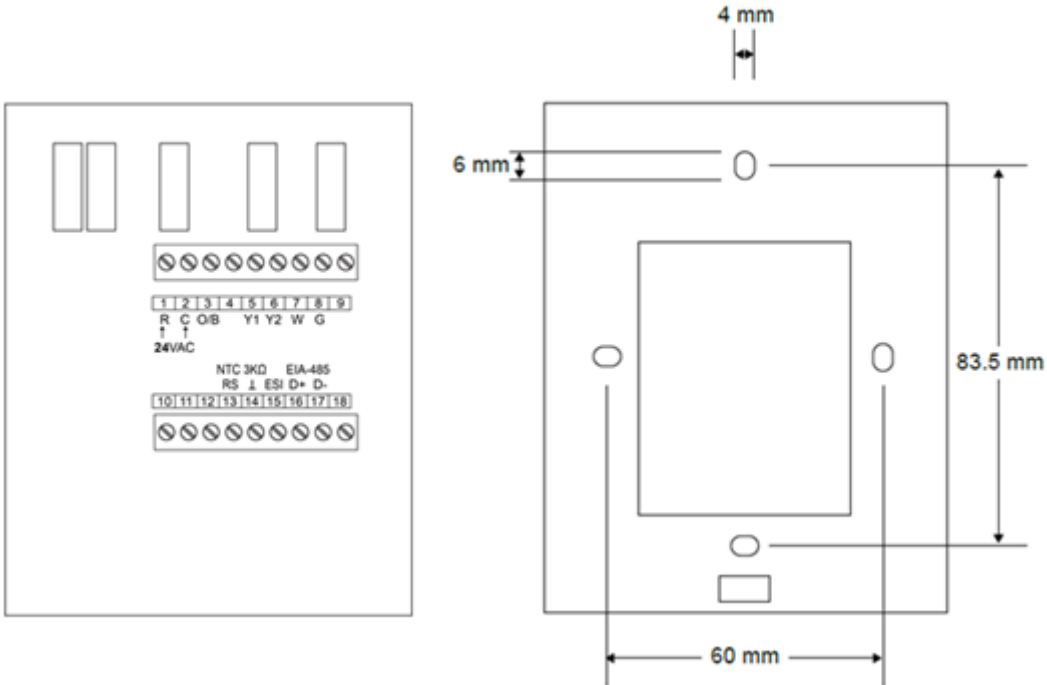
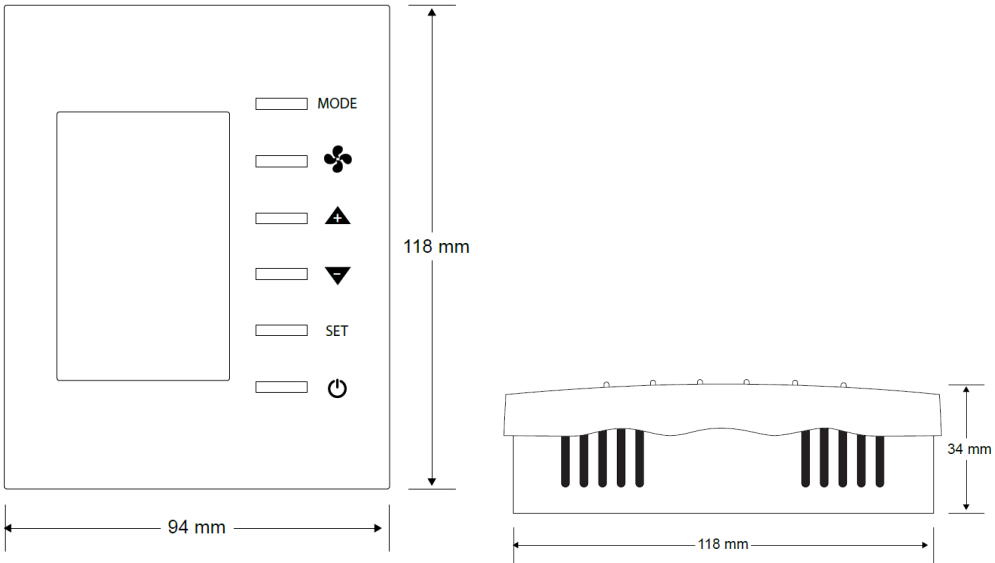

3 Installation

The BAST-321HP-B2 is intended for surface-mount installation on an interior wall, away from direct sunlight or direct air movement. The display (top half) can be removed from its base by loosening the small Philips screw at the bottom of the display. Once the display is removed from the base, the base can be mounted onto the wall with appropriate fasteners. If a single-gang electrical junction box is to be used, the top and bottom mounting holes will align with the screw holes in the junction box.

3.1 Terminal Block Pin Assignments

Two terminal blocks are provided for all field connections. The remote sensor input (RS2) is at terminals 14 and 18. The Local Occupancy (ESI) input is wired to terminals 14 and 15- with a default setting of : Open= Occupied, Closed= Unoccupied. The Outside Air Temperature (OAT) is wired to terminals 13 and 14. RS-485 is wired to terminals 16 and 17.

Number	Mark	Comment	Number	Mark	Comment
1	R	24 VAC high-side	10		
2	C	24 VAC common	11		
3	O/B	Reversing Valve	12		
4			13	RS	Remote Temperature
5	Y1	Compressor 1	14	GND	Ground
6	Y2	Compressor2	15	ESI	Energy Saving Input
7	W	3 rd Stage Auxiliary Heat	16	C+	RS-485 Positive
8	G	Fan	17	C-	RS-485 Negative
9			18		

3.2 Limited Power Source

The BASstat is intended to be powered by a Class 2 compliant power source and only accepts 24VAC with no more than 5VA of power consumption. It should be powered by a Class 2 power source complying with the requirements of the National Electric Code (NEC) article 725. The transformer or power supply complying with the Class 2 rating must carry a corresponding listing from a regulatory agency such as Underwriters Laboratories (UL).

3.3 Power Supply Precautions

Internally, the BASstat utilizes a half-wave rectifier and can share the same AC power source with other half-wave rectified devices. Sharing AC power with full-wave rectified devices is NOT recommended. AC power sources that power several half-wave devices have a common secondary connection called COMMON, LO, or GROUND. Connect the HOT side of the secondary to the 24 VAC high side input on the BASstat and the LO side to 24 VAC common.

WARNING: Devices powered from a common AC source could be damaged if a mix of half-wave and full-wave rectified devices are both present. If you are not sure of the type of rectifier used by another device, do not share the AC source with it.

3.4 Wiring Diagram

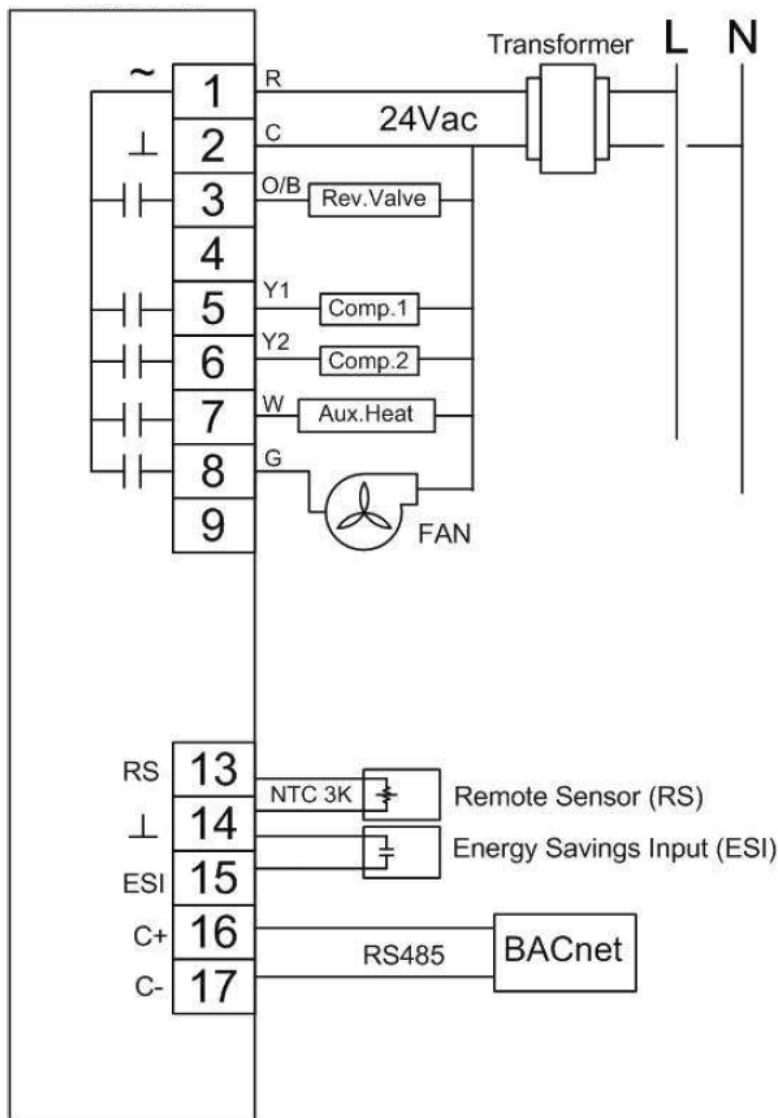

4 Operation



4.1 User Mode



User-side control is accomplished with six buttons – MODE (Heat, Cool, or Ventilate), FAN (Auto or On), UP, DOWN, SET, and POWER. There are options to lock the panel buttons to limit user access if so required. A large LCD display indicates setpoint, space temperature, occupancy status, and current mode of operation using graphical icons.



System modes (Cool, Heat, Ventilate) available to the user are dependent on control type chosen from *Engineering Menu (tyPE)* or BACnet object [*MSV8*] *Control Type*. See section 4.2 *Control Type* of this manual).

System modes and button operation may be limited by installation engineer, especially if the thermostat is completely controlled over BACnet network.

The first tier of operation includes the following settings as shown below. To operate the thermostat:





1. The POWER button  toggles between ON or OFF states to start / stop the thermostat outputs. (ON/OFF control can be accomplished over BACnet as well).
2. At power ON, press any button to start the User Mode operation. Press the MODE button  to toggle between different HVAC operating modes such as Cool, Heat, or Ventilate@Cool and Ventilate@Heat.

Press the UP/ DOWN buttons   to adjust temperature setpoint or rotate the values of a menu setting. Press the FAN button  to toggle fan modes of AUTO or CONTINUOUS On. If no AUTO icon is displayed, the fan will run continuously until commanded off using button on thermostat or BACnet command. If AUTO icon is flashing, the fan is operating under delay timer and will shut off automatically when the end of cycle delay timer expires.

Press the SET button  and use UP/ DOWN buttons   to toggle the unit between Occupied or Unoccupied states when outside of scheduled operation. Use SET or MODE to apply (SET button can be locked in applications forbidding occupancy state user control).

3. Thermostat will return to normal display with the last known setting if no button is pressed for 10 seconds.

User Mode Thermostat Operation

#	Item	Description	Remarks
1	Normal Display	Display current room or set-point temperature.	Use the (SP) parameter in the Engineering Menu or [MSV7] Display to choose Current room or Set- point temperature on display.
2	Temperature Setpoint Setting using Up/Down Arrows 	Set the desired temperature.	The [AV0] / [AV3] Cool / Heat Occupied and [AV8] / [AV9] Unoccupied Cool / Heat temperature setpoints BACnet objects can be used to write or force the setpoint to a desired value from BACnet supervisor.
3	Mode Select 	Select the working mode: Cooling (❄️), Heating (🔥), or Ventilating (🌀)-P[After pressing the MODE button, press the UP/ DOWN button to rotate the selections. Dependent on Control Type.
4	Fan Auto/ Continuous 	Change the Fan mode between Auto or Continuous On.	When AUTO is displayed, the fan is handled automatically. When AUTO is flashing, the fan is working under a delay timer. When FAN icon is spinning but AUTO is not displayed, the fan will run continuously until commanded off.
5	Occupancy Setting 	Press SET, Used UP and DOWN arrows to toggle between the Occupied and Unoccupied setting. Use MODE or SET buttons to apply.	The SET button could be locked for applications forbidding user occupancy state control.

User Mode Flow Chart

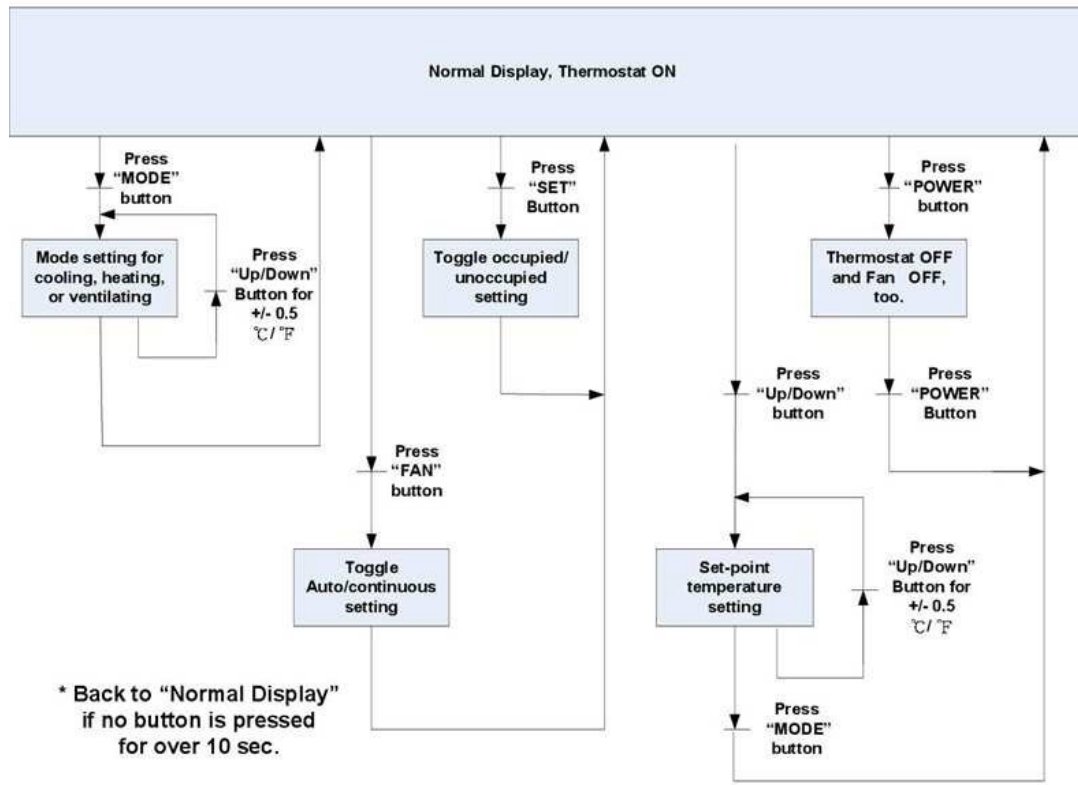

4.2 Control Type

Control Type, System Mode and Algorithm Configuration

System modes available to the user are dependent on control type.

Multi-stage Cooling or Heating with Auto Changeover – This is the default control type in this thermostat. Mostly used for standalone operation. The thermostat will switch between Cool and Heat modes automatically. In this control type, the user will be presented with a choice of *Heat* or *Ventilation@Heat* when the thermostat is in *Heat* mode (automatic), and *Cool* or *Ventilation@Cool* when the thermostat is in *Cool* mode (automatic).





Multi-stage Cooling or Heating with Manual Changeover – In this control type the thermostat will wait for a command from user or BACnet supervisor to switch between Cool and Heat modes. The user will be presented with a choice of *Heat* or *Ventilation@Heat* when the thermostat is in *Heat* mode, and *Cool* or *Ventilation@Cool* when the thermostat is in *Cool* mode. The user can choose to switch between Cool and Heat modes using the MODE button.

BACnet controlled – In this control scheme, the built-in thermostat algorithm can be bypassed, and the thermostat can be controlled over the BACnet network with commands from the supervisor device. The logic executing in the supervisor (such as Niagara or Sedona logic) can control the thermostat over the BACnet network. To put the thermostat in BACnet network control mode, use the Lock [AV18] object bit 9: Control DOs by thermostat algorithm “0” (default) or BACnet supervisor “1” (add decimal=512).

Cool Only (nullified/disabled in firmware), and *Heat Only (nullified/disabled in firmware)* control types are listed in the BACnet object and Engineering Menu object but are not available for use.

Control type is only configurable by the installer using Engineering Mode Menu or BACnet supervisor. The installer must decide the control type suitable for the application, set it to a static value, or program the BACnet supervisor to change the control type automatically. The default control type is set to Cooling or heating with Auto Changeover. This is the most common control type. Manual Changeover can be used to limit frequent automatic change of system modes (Cool or Heat).

Algorithm

- A PID adaptive control algorithm is applied to minimize overshoot, in addition to proportional band (Stage Width) and derivative (Differential) calculation.
- When the thermostat is active (either the heating or cooling stage is on), a “Working ()” icon will be shown on the LCD. Stage 1 will show icon (). Stage 2 will show icon () 3rd stage heat will show icon ().

System Mode

- The default control type is multi-staged cooling and heating with automatic changeover, allowing the thermostat to operate as stand-alone. Manual Changeover allows restriction of mode selection to Cool only or Heat only where necessary. Control Type can be selected in (tyPe) or [MSV8].
- For manual changeover control, cooling or heating system modes can be selected by pressing the MODE button or using a BACnet command to object[MSV1]. In application where user control needs to be limited, the lock button function can be used to disable MODE button.
- Occupied Cooling [AV0] and Heating [AV3] set points and Unoccupied Cooling [AV8] and Heating [AV9] setpoints can be set individually. Minimum deadband [AV7] can be programmed as well.

Short On/Off (Minimum On/Off time) and Maximum cycles per Hour

- There are short on/off (minimum off time and minimum on time of stage engagement) and maximum cycles per hour protection for cooling and heating mode (E29, E31, E54, E55; AV24, AV26, AV46, AV47).
- Short on/off time (in seconds) will check minimum on time and minimum off time of each stage before changing its state.

- Maximum cycles per hour will check cycle times in a particular hour. When the cycle times reach the setting maximum cycles in that hour, it won't allow more cycles until next hour.
- When the stage state change is pending by Short Cycle Delay or Maximum Cycles, the Clock icon (🕒) will appear on the LCD.

Next Stage Engagement Short Cycle Delay

There needs to be an automatic delay (Short Cycle, default 5 minutes, E28/ AV23 for cooling control, E30/AV25 for heating control) before starting the second stage to prevent possible damage to the DX equipment.

Reversing Valve Polarity

Reversing Valve N.O./N.C. for cooling and heating mode changeover is defined by E53/BV3. The default setting at pin 3 (O/B) is open for cooling and closed for heating.

(2-Stage Cooling and 3-Stage Heating Control, Auto changeover)

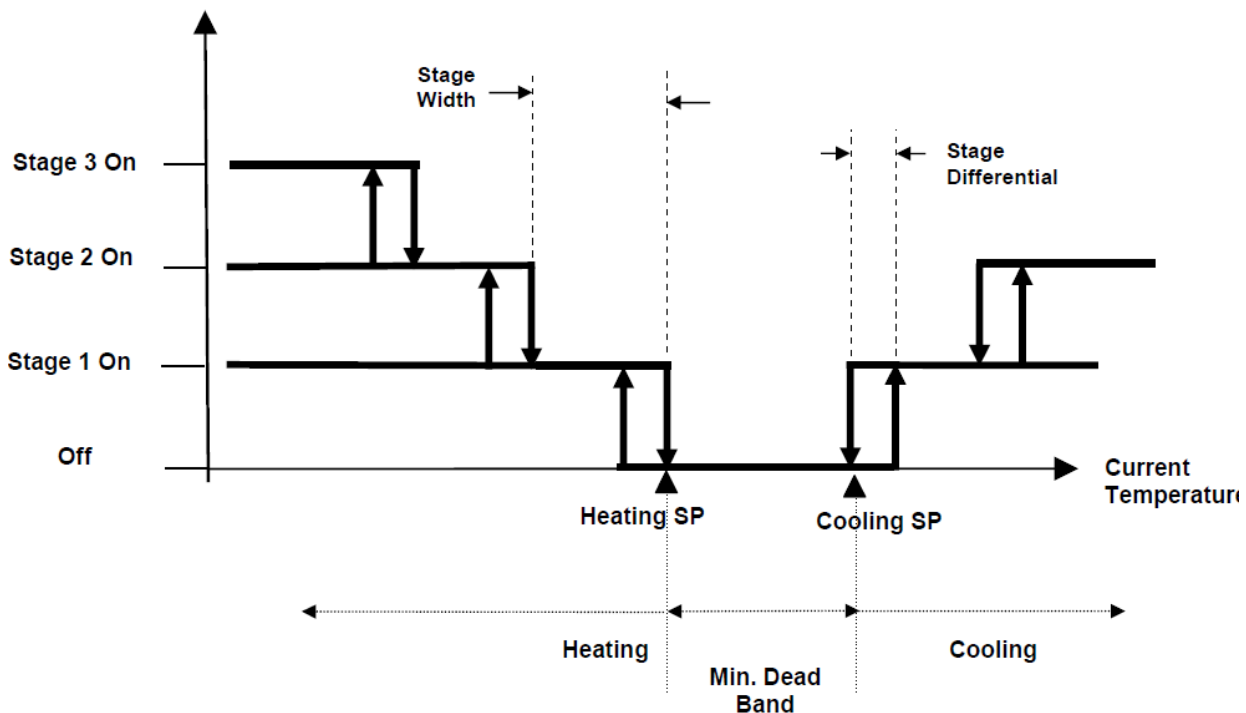

Floating Deadband

The Heat and Cool temperature setpoints could be “attached” together. This means that as one setpoint is adjusted and “hits” against the deadband region, it will “push” the deadband region and the other setpoint along the temperature setpoint axis to allow for adjustment while maintaining the configured deadband. If the setpoint is adjusted back the other way, it will “pull” the deadband region and the other setpoint along the temperature setpoint axis.

Minimum Cooling Setpoint and Maximum Heating Setpoint

- Minimum Cooling Setpoint will be confined by set point low limit plus dead band and Minimum cooling setpoint [E46/AV-39] default: 18°C/ 65°F
- Maximum Heating Setpoint will be confined by set point high limit minus dead band and Maximum heating setpoint [AV-40] default: 25°C/ 77°F

Assigned Current Temperature



A current temperature value can be assigned thru BACnet AV-1 to take place of the onboard temperature sensor value. The assigned value is valid if BACnet communication is driving a flip-flop signal to (BV-16: heartbeat signal) within the (AV-29: Heartbeat Rate time) period (in seconds). Otherwise, the assigned temperature will revert back to the onboard sensor reading.

Fan Control Output

- Lowest Fan Speed is the speed the fan will default to after a control action (Heating or Cooling) with fan in AUTO mode. If the lowest fan speed [MSV4] is set as “Stop (1)”, the fan will automatically shut off after the control action plus a 2-minute fan-off time delay. During this delay, the AUTO icon will flash. If lowest fan speed is set to “Low (2)” the fan will run continuously after a control action
- Fan Mode can be toggled between AUTO or ON by using the FAN button on the thermostat or BACnet object [MSV0] Fan Mode (BACnet supervisor). By default, this value is set to “Auto(1)”, the AUTO icon is displayed, and fan operation will be controlled automatically. To put the fan in ON mode set [MSV0] to “Low(2)”. This will cause the fan to run continuously (no AUTO icon is displayed). Fan icon spins when fan is active. The FAN button can be locked to limit user access to this feature or the BACnet supervisor can be programmed to default the thermostat to certain state at the end of an occupancy cycle.
- During heating operations, the supply fan is controlled by the BASstat. This is enabled by default. (BV15 =1)

Occupancy Setting

There are several ways to define thermostat occupancy state. *Note:* Occupancy will be detected by ESI contact by default.

- Energy Savings Input (ESI) This is a dry contact input meant for communication from a customer supplied occupancy sensor. (default)
- Occupancy status (occupied/unoccupied) can be set by a BACnet supervisor using writable object *ESI Contact Definition [BV14]*. “0” for occupied, and “1” for unoccupied. E12/AV18 must be set with a value of 64 (disabled) in advance (E12/AV18 is set as 0 by default)
- User control of occupancy state is allowed from the SET button if E12/ AV18 Lock has the ESI Contact disabled. Pressing the SET button and UP/DOWN buttons will toggle the occupancy state. Press SET button to confirm. The SET button can work in conjunction with *BACnet occupancy Command [BV14]* on last-write-wins basis. The SET button could be locked to limit user control (use *Lock [AV18]* BACnet object or (*LOC*) engineering menu item to lock SET button). In this case only the BACnet supervisor can set occupancy states.
- *Occupancy Status [B10]* is a read-only BACnet object indicating current occupancy state - “0” for occupied, and “1” for unoccupied. (AV18 is set as 0 by default).
- When in unoccupied state, a Moon () icon will be displayed on the LCD and the thermostat will change the set-point temperatures to the *Unoccupied Cool* and *Unoccupied Heat* setpoints [AV8 – 9]. When the state changes back to occupied, the thermostat will return to the occupied set-point values for Cooling and Heating
Temperature Setpoint [AV0, AV3] and sunlight icon () will be displayed to indicate occupied state on LCD.

4.3 Engineering Mode Menu

Thermostat configuration can be performed using the engineering menu or by controlling BACnet objects using a BACnet client tool such as Contemporary Controls free [BACnet Discovery Tool \(BDT\)](#). It is highly suggested that engineering mode be operated by trained installers only because it is related to system parameters that will affect the control results.

Operation of Engineering Menu

- At power “ON”, press and hold both the UP and DOWN buttons simultaneously for 5 seconds to enter the Engineering Mode menu.
- Press the UP or DOWN buttons to rotate through the menu items. The last item loops back to first item at the end of items in menu. Press the MODE button to enter a submenu item.
- Press the UP or DOWN button to change the setting in the submenu item. Press the MODE button to confirm the setting and return to menu item

Engineering Menu Items Table

Item	Mnemonic	Description	°C Scale		°F Scale		Step
			Default	Range	Default	Range	
E1	db	Deadband	2.0	0~10	4.0	0~18	0.5 (°C/°F)
E2	ESIC	Unoccupied(ESI) cooling set point	28	25~35	82.5	77~95	1.0 (°C/°F)
E3	ESIH	Unoccupied(ESI) heating set point	15	10.0~22.0	59	50.0~72.0	1.0 (°C/°F)
E4	I-t	Integral Time and Output Cycle Time (seconds)	60	0~500	60	0-500	10 (Sec.)
E5	OPL1	Not used					
E6	SPA1	Not used					
E7	SP-L	Low limit for temperature set point	10	0~50	50	32~122	1.0 (°C/°F)
E8	SP-H	High limit for temperature set point	30	0~50	95	32~122	1.0 (°C/°F)
E9	OFSt	Current temperature offset	0.0	10.0~10.0	0.0	18.0~18.0	0.1 (°C/°F)
E10	Pb	Proportional band or stage width	1.5	0~10.0	3.0	0~18.0	0.1 (°C/°F)
E11	diFF	Stage differential	0.5	0.1~1.0	1.0	0.1~1.8	0.1 (°C/°F)
12	LOC	<p>Bit Definition:</p> <p>0: MODE button (dec=1) 1: Down buttons (dec=2) 2: Up button (dec=4)</p> <p>3: FAN SPEED button (dec=8) 4: Power On/Off button (dec=16) 5: SET (or °C/°F) button (dec=32)</p> <p>6: ESI contact detection (dec=64) 7: Door/Window contact detection (dec=128)</p> <p>8: Modification for communication parameters (dec=256) i.e. baud rate, MAC addr, device inst.</p> <p>9: Control DOs by thermostat algorithm (0) or BACnet sup. (1) (dec=512)</p> <p>10~15: reserved/unused</p> <p>Bit Value 0: Unlock / enable 1: Lock / disable</p> <p>Examples (add dec values to lock multiples) Unlock/enable all (0) Lock MODE Button (1) Lock Down Button (2) Lock MODE & Down Buttons (3 = 1+2) Lock Power On/Off button (4) Lock MODE & Power & Down (7 = 1+2+4) Lock SET button (32) Lock MODE & Down & Power & SET (39 = 1+2+4+32) ESI contact disable (64) Lock the modification for communication parameters (256) DOs control commanded by BACnet (512)</p>	64	0-1023	64	0-1023	1

Item	Mnemonic	Description	°C Scale		°F Scale		Step
			Default	Range	Default	Range	
E13	ESI	ESI contact definition	0	0~1	0	0~1	0: N.O. 1: N.C.
E14	rE-C	Not used					
E15	rE-H	Not used					
E16	rS	Space Temperature input from built-in temperature Sensor, remote temperature sensor, or assigned via BACnet	0	0~2	0	0~2	0: built-in 1: remote sense 2: assigned via BACnet
E17	-SP-	Display present temperature value of or current set-point as default for LCD	0	0~1	0	0~1	0: display PV 1: display SP
E18	door	Door or Windows contact definition (not applicable to all models)	0	0~1	0	0~1	0: N.O. 1: N.C.
E19	LFAn	Lowest Fan speed in Auto fan mode	0	0~1	0	0~1	0: stop 1: low
E20	Pct	Output Percentage (not used)	0	0~100	0	0~100	1%
E21	Baud**	Baud Rate	38.4 (depends on Model Number.)	9.6 kbps 19.2 kbps 38.4 kbps 57.6 kbps 76.8 kbps	38.4 (depends on Model Number.)	9.6 kbps 19.2 kbps 38.4 kbps 57.6 kbps 76.8 kbps	
E22	Addr**	MSTP MAC Address	1	0~AdrH (Default: 0~127)	1	0~AdrH (Default: 0~127)	
E23	dEUH**	Device instance no. - Hi bytes	100	0~4194	100	0~4194	1
E24	dEUL**	Device instance no. - Low bytes	1	0~999 (if ID-H <=4193) 0~302 (if ID-H = 4194)	1	0~999 (if ID-H <=4193) 0~302 (if ID-H = 4194)	1
E25	AdrH	Max_Master -- The highest allowable address for master nodes	127	1-127	127	1-127	1
E26	rHSt	Relative Humidity Offset	0		0	-30.0 ~30.0	0.1%RH
E27	F-Ht	Fan Output for Heating	1	0/1	1	0/1	0: Disable 1: Enable
E28	dLyC	Cooling Stage Delay	5	0~10	5	0~10	(minutes)
E29	cycC	Cooling Maximum Cycles per Hour	4	2~6	4	2~6	(cycles/hour)
E30	dLyH	Heating Stage Delay	5	0~10	5	0~10	(minutes)

Item	Mnemonic	Description	°C Scale		°F Scale		Step
			Default	Range	Default	Range	
E31	cycH	Heating Maximum Cycles per Hour	4	2~6	4	2~6	(cycles/hour)
E32	tyPE	Control Type	2	1~2	2	1~2	0: Cooling Only 1: C&H Manual 2: C&H Auto 3: Heating Only NOTE: Cool only and Heat only types disabled
E33	OPL2	Minimum Output for AO2 <i>(not used)</i>					
E34	SPA2	Span Offset for AO2 <i>(not used)</i>					
E35	Hrtr	Communication Heartbeat Minimum Rate	60	10~3600	60	10~3600	10s
E36	rhPb	Humidity Control PB					
E37	rhdF	Humidity Control Diff.					
E38	Pb-2						
E39	CO2F	CO2 Offset Value					
E40	AFtH	After Hour Extension Time <i>(not used)</i>					
E41	AI-L	Input low Value					
E42	AI-H	Input High Value					
E43	OPtS	Options <i>(not used)</i>					
E44	dlAb	DI contact Definition					
E45	Hrt	Communication Heartbeat Flip-Flop	0	0/1	0	0/1	0: Off 1: On
E46	CSPL	Minimum Cooling Temperature Setpoint	18.0	0.0-50.0	65.0	32.0- 100.0	0.1 (°C/°F)
E47	HSPH	Maximum Heating Temperature Setpoint	25.0	0.0-50.0	77.0	32.0-	0.1 (°C/°F)
E48	nFAn	Minimum Fan Output <i>(not used)</i>					
E49	hFAn	Maximum Fan Output <i>(not used)</i>					
E50	FAnL	Low Fan Speed Setting <i>(not used)</i>					
E51	FAn2	Med. Fan Speed Setting <i>(not used)</i>					
E52	FAnH	Hi Fan Speed Setting <i>(not used)</i>					
E53	ObAb	Reversing Valve Polarity	0	0/1	0	0/1	Cooling/ Heating 0: N.O./ N.C.
E54	OFFt	Minimum Off Time	180	0~600	180	0~600	5 (seconds)
E55	On-t	Minimum On Time	0	0~600	0	0~600	5 (seconds)
E56	It-2	Integral Time and Output Cycle Time 2					

E57	tEst	Self Diagnostic					
E58	rSt	Reset all parameters as factory defaults					
E59	End	Exit Engineer Mode					

** Note: 1. Changing these values needs to unlock modification for communication parameters in advance.

Please refer to the parameter LOC(Lock, AV17) for details.

2. Device instance number = “devH” *1000 + “devL” = 0~4194302. ex. If “devH” is 100 and devL” is 001, then the Device instance number = 100001.

Lock Function Setup and Examples

The 16-bit binary encoded decimal register accessed through *Lock* [AV17] BACnet object and LOC engineering menu item is used to enable/disable features in the thermostat. The first 10 bits are used (bit 0 ~ bit 9), bits 10~15 are reserved/unused. Bits are represented by their decimal values and are added or subtracted to toggle from “0” to “1”. Add a bit’s decimal value to toggle to “1” or subtract a bit’s decimal value to toggle to “0”. See table below.

<p>Bit Definition: Decimal Value to Write:</p> <p>0: MODE button (dec=1) 1: DOWN button (dec=2) 2: UP button (dec=4) 3: FAN SPEED button (dec=8) 4: POWER On/Off button (dec=16) 5: SET (or °C/°F) button (dec=32) 6: ESI contact detection (dec=64) 7: Door/Window contact detection (unused) (unused) 8: Modification for communication parameters (dec=256) i.e., baud rate, MAC addr, device inst. 9: Control DOs by thermostat algorithm (0) or BACnet sup. (1) (dec=512) 10~15: reserved/unused (unused)</p> <p>Bit Value:</p> <p>0: Unlock / enable 1: Lock / disable</p>	<p>Add decimal values to lock multiples. Bold decimal number is the example value to write to Lock object. Examples:</p> <p>Unlock/enable all (0) – this will also enable ESI DI1 to control occupancy command by default. (add 64 to all values below to maintain default occupancy selection over BACnet).</p> <p>Lock MODE Button (1) Lock DOWN button (2) Lock MODE & DOWN (3 = 1+2) Lock UP button (4) Lock MODE & DOWN & UP (7 = 1+2+4) Lock FAN SPEED button (8) Lock MODE & DOWN & UP & FAN (15 = 1+2+4+8) Lock POWER button (16) Lock MODE & DOWN & UP & FAN & POWER (31 = 1+2+4+8+16) Lock SET button (32) Lock MODE & DOWN & UP & FAN & POWER & SET (63 = 1+2+4+8+16+32)</p> <p>ESI contact disable (64 – default). When the default value of 64 is maintained, occupancy is set over BACnet and SET user button.</p> <p>Lock MODE & DOWN & UP & FAN & POWER & SET & disable ESI DI1 (127 = 1+2+4+8+16+32+64)</p> <p>Door/Window contact detection (unused)</p> <p>Lock the modification for communication parameters such as baud rate and mac address (256)</p> <p>Lock MODE & DOWN & UP & FAN & POWER & SET & disable ESI DI1 & modification for communication parameters (383 = 1+2+4+8+16+32+64+256)</p> <p>DOs control commanded by BACnet (512)</p>
---	---

4.4 BACnet Objects and Network Configuration

Transmission types

- Physical layer: EIA-485
- Protocol: BACnet MS/TP
- Baud rate: 9600~76800 (38400 bps default)
- MAC address 1 (default)
- Device Instance: 600001 (default)

Initial Configuration

All configuration parameters are settable through use of the buttons on thermostat by entering the *Engineer Menu*, or once installed on the BACnet network, configuration can also be altered using BACnet commands. Network command-based configuration can also be accomplished using a [laptop/computer/tablet and Contemporary Controls' free BACnet Discovery Tool.](#)

Reset Settings

The BASstat will store configuration in the event of power loss.

- Reset will restore all values to default and can be selected from engineering menu (rSt).

BACnet Object Table

Object name	Type & Instance	Object Property (Readable/Writable)	Range
BACnet Thermostat	Device 600001	Model Name (R)	623C
		Application Software Version (R)	JAN 28 2022
		Object Identifier (R)	
		Object Name (R/W)	32 characters (max.)

Object name	Type & Instance	Readable/ Writable	Description	Range and Definition
Current Temperature	AI 0	R	Current Temperature	-999~9999: -99.9~999.9 °C/°F
Active Temperature Setpoint	AI 1	R	Active Temperature Set-Point	°C :0~500 (0.0~50.0°C) °F : 320~1220 (32.0~122.0°F)
Built-in Space Temperature Sensor	AI 2	R	Built-in Space Temperature Sensor Reading	-999~9999:-99.9~999.9 °C/°F
Remote Temperature Sensor	AI 3	R	Remote Temperature Sensor Reading	-999~9999:-99.9~999.9 °C/°F
Current Humidity	AI 4	R	Current Humidity	0~1000: 0.0~100.0%RH
Current Dew Point	AI5	R	Current Dew Point	-999~9999: -99.9~999.9 °C/°F
Current CO2	AI 6	R	Current CO2 Reading	0~3000: 0~3000 ppm
Control Valve	AI 7	R	Control Valve Feedback	0~1000 (0.0%~100.0%)
Modulating/ Floating Output 1	AI 8	R	Modulating/ Floating Output 1	0~100: 0~100 %
Modulating/ Floating Output 2	AI 9	R	Modulating/ Floating Output 2	0~100: 0~100 %
Modulating Fan Output	AI 10	R	Modulating Fan Output	0~100: 0~100 %
Control Output	AI 11	R	Control Output Percentage	0~100: 0~100 %
Input Valve	AI 12	R	Input Valve	-1000~1000 (-100.0~100.0)
Analog Input Valve	AI 13	R	Analog Input Valve	-1000~1000 (-100.0~100.0)
2 nd Remote Temperature Sensor	AI 14	R	2 nd Remote Temperature Sensor Reading Value	-999~9999:-99.9~999.9°C
3 rd Remote Temperature Sensor	AI 15	R	3 rd Remote Temperature Sensor Reading Value	-999~9999:-99.9~999.9°C

Object name	Type & Instance	Readable/ Writable	Description	Range and Definition
Cooling Temperature Setpoint	AV 0	R/W	Cooling Temperature Set Point	°C :0~500 (0.0~50.0°C) °F: 320~1220 (32.0~122.0°F)
Space Temperature via Network	AV 1	R/W	Space Temperature Via Network	-999~9999 (-99.9~999.9°C/°F)
Timer Off	AV 2	R/W	Timer Off (Only for Models with Countdown Timer Function Available).	0~24: 0~24 Hours Count Down 0: Disable
Heating Temperature Setpoint	AV 3	R/W	Heating Temperature Set Point	-999~9999: -99.9~999.9 °C/°F
Hr-Running Time	AV 4	R/W	Running Time of Valve (Hr.)	0~65535 (Hr.) For Reading But 0~30000 (Hr.) For Writing.
M-Running Time	AV 5	R/W	Running Time of Valve (M.)	0~59 (Minute)
Sec-Running Time	AV 6	R/W	Running Time of Valve (Sec.)	0~59 (Sec.)
Deadband	AV 7	R/W	Deadband	0-18° 4°min. recommended
Unoccupied Cool Setpoint	AV 8	R/W	Unoccupied Cooling Setpoint	°C: 250~300 (25.0~30.0°C) °F: 770~860 (77.0~86.0°F)
Unoccupied Heat Setpoint	AV 9	R/W	Unoccupied Heating Setpoint	°C: 100~220 (10.0~22.0°C) °F: 500~715(50.0~71.5°F)
Integral-Cycle Time	AV 10	R/W	Integral Time and Output Cycle Time	0~500 (Sec.)
Analog Minimum Output for AO1	AV 11	R/W	Minimum Output Voltage in Digital Value When Reach	0~125 (LSB)
Span Offset for AO1	AV 12	R/W	Span Offset for AO1	-55~0 (LSB)
Low Setpoint Limit	AV 13	R/W	Low Limit for Set-Point Temperature	°C :0~500 (0.0~50.0°C) °F: 320~1220(32.0~122.0°F)
High Setpoint Limit	AV 14	R/W	High Limit for Set-Point Temperature	°C :0~500 (0.0~50.0°C) °F: 320~1220(32.0~122.0°F)
Temperature Offset	AV 15	R/W	Offset for Current Temperature	°C: -100~100 (-10.0~10.0°C) °F: -180~180 (-18.0~18.0°F)
Proportional Band-Stage Width	AV 16	R/W	Proportional Band or Stage Width	°C :0~100 (00~10.0 °C) °F: 0~180 (00~18.0 °F)
Stage Differential	AV 17	R/W	Stage Differential	°C :1~10 (0.1~1.0 °C) °F: 1~18 (0.1~1.8 °F)

Object name	Type & Instance	Readable/Writable	Description	Range and Definition
Lock	AV 18	RW	LOCK	<p>Bit Definition:</p> <p>0: MODE button (dec=1) 1: Down button (dec=2) 2: Up button (dec=4) 3: FAN SPEED button (dec=8) 4: Power On/Off button (dec=16) 5: SET (or °C/°F) button (dec=32) 6: ESI contact detection (dec=64) 7: Door/Window contact detection (dec=128) 8: Modification for communication parameters (dec=256) i.e. baud rate, MAC addr, device inst. 9: Control DOs by thermostat algorithm (0) or BACnet sup. (1) (dec=512) 10~15: reserved/unused</p> <p>Bit Value 0: Unlock / enable 1: Lock / disable</p> <p>Examples (add dec values to lock multiples) For more details see Lock Function Setup and Examples section of this manual</p>
Control Out	AV 19	R/W	Percentage of Modulating/ Floating Control Output	0~100 (0%~100%)
MAC Address	AV 20	R/W	MAC Address	0~127
Device Instance	AV 21	R/W	Device Instance	0~4194302 (Note: Changing this value needed to unlock modification for communication parameters in advance. i.e. AV17=0~255 or 512~768. Please refer to LOCK(AV17) for details)
Humidity Offset	AV 22	R/W	Humidity Offset Value	-300~300 (-30.0~30.0 %RH)
Cooling Short Cycle	AV 23	R/W	Cooling Short Cycle Delay	0~10 Minutes

Object name	Type & Instance	Readable/Writable	Description	Range and Definition
Cooling Maximum Cycles per Hour	AV 24	R/W	Cooling Maximum Cycles per Hour	2~6 Cycles
Heating Short Cycle	AV 25	R/W	Heating Short Cycle Delay	0~10 Minutes
Heating Maximum Cycles per Hour	AV 26	R/W	Heating Maximum Cycles per Hour	2~8 Cycles
Analog Minimum Output for AO2	AV 27	R/W	Minimum Output Voltage in Digital Value When Reach Low Limit for AO2	0~125 (LSB)
Span Offset for AO2	AV 28	R/W	Span Offset for AO2	-55~0 (LSB)
Heartbeat Rate	AV 29	R/W	Communication Heartbeat Minimum Rate	10~3600 s
Humidity Proportional Band-Stage Width	AV 30	R/W	Proportional Band or Stage Width for Humidity Control Output	0~1000 (0.0~100.0) %RH
Humidity Stage Differential	AV 31	R/W	Stage Differential for Humidity Control Output	0~1000 (0.0~100.0) %RH
Proportional Band for stage width 2	AV 32	R/W	Stage Diff for humidity control	0-18
CO ₂ Offset	AV 33	R/W	CO ₂ Offset Value	-1000~2000 ppm
After Hour Extension Run Time	AV 34	R/W	After Hour Extension Run Time	5~20(0.5~2.0) Hour
Input Low Value	AV 35	R/W	Input Low Value	-1000~1000 (-100.0~100.0 %)
Input High Value	AV 36	R/W	Input High Value	-1000~1000 (-100.0~100.0 %)
Options	AV 37	R/W	Options	Bit Definition --- Bit 0: T or SP Bit 1~15: Reserved
DI Contact Definition	AV 38	R/W	DI Contact Definition	Bit Definition --- Bit 0: DI-1 1: DI-2 Bit 2~15: Reserved *Bit value:0-NO, 1-NC
Minimum Cooling Temperature Setpoint	AV 39	R/W	Minimum Cooling Temperature Setpoint	°C:0~500 (0.0~50.0°C) °F: 320~1220 (32.0~122.0°F)
Maximum Heating Temperature Setpoint	AV 40	R/W	Maximum Heating Temperature Setpoint	°C:0~500 (0.0~50.0°C) °F: 320~1220 (32.0~122.0°F)
Minimum Fan Output	AV 41	R/W	Minimum Fan Output at Auto Fan Mode (for Modulating Fan Application)	0%~Reg 51

Object name	Type & Instance	Readable/Writable	Description	Range and Definition
Maximum Fan Output	AV 42	R/W	Maximum Fan Output at Auto Fan Mode (for Modulating Fan Application)	0%~Reg 51
Low Fan Speed Setting	AV 43	R/W	Low Fan Speed Setting (for Modulating Fan Application)	0%~Reg 53
Med. Fan Speed Setting	AV 44	R/W	Med. Fan Speed Setting (for Modulating Fan Application)	Reg 52~Reg54
Hi Fan Speed Setting	AV 45	R/W	Hi Fan Speed Setting(For Modulating Fan Application)	Reg 53~100%
Minimum Off Time	AV 46	R/W	Minimum Off Time	0~600 seconds
Minimum On Time	AV 47	R/W	Minimum On Time	0~600 seconds
Stroke Time	AV 48	R/W	Integral Time and Output Cycle Time 2	10~1600 sec..
Set Point for Humidity	AV 49	R/W	Set Point for Humidity Control	0~1000 (0.0~100.0 %RH)
Dew Point Set Point	AV 50	R/W	Dew Point Temperature Set Point	-999~9999: -99.9~999.9 °C/°F
Occupancy Status	BI 0	R	Status of Occupancy	0: Room Occupied 1: Room Unoccupied
Window-Door Status	BI 1	R	Window/ Door Status	0: Door/Window Closed 1: Door/Window Open
Cooling-heating Status	BI 2	R	Status of Cooling/Heating Control Output	0: Close & Off 1: Open & On
Relay 1 Status	BI 3	R	Status of Relay 1 (O/B Valve)	0: Off, 1: On
Relay 2 Status	BI 4	R	Status of Relay 2 (Comp 1)	0: Off, 1: On
Relay 3 Status	BI 5	R	Status of Relay 3 (Comp 2)	0: Off, 1: On
Relay 4 Status	BI 6	R	Status of Relay 4 (Aux. Heating Stage 3)	0: Off, 1: On
Relay 5 Status	BI 7	R	Status of Relay 5	0: Off, 1: On
Relay 6 Status	BI 8	R	Status of Relay 6	0: Off, 1: On
Relay 7 Status	BI 9	R	Status of Relay 7 (Fan)	0: Off, 1: On
DI 1 Status	BI 10	R	Status of Digital Input 1	0: Off, 1: On
DI 2 Status	BI 11	R	Status of Digital Input 2	0: Off, 1: On
DI 3 Status	BI 12	R	Status of Digital Input 3	0: Off, 1: On

Object name	Type & Instance	Readable/ Writable	Description	Range and Definition
DI 4 Status	BI 13	R	Status of Digital Input 4	0: Off, 1: On
DI 5 Status	BI 14	R	Status of Digital Input 5	0: Off, 1: On
DI 6 Status	BI 15	R	Status of Digital Input 6	0: Off, 1: On
DI 7 Status	BI 16	R	Status of Digital Input 7	0: Off, 1: On
Fan Status	BI 17	R	Fan Status	0: Off, 1: On
Flow Switch Status	BI 18	R	Differential Pressure (Air Flow) Switch Status	0: Off, 1: On
Trip Status	BI 19	R	Trip Alarm Status	0: Off, 1: On
Filter Status	BI 20	R	Filter Dirty Alarm Status	0: Off, 1: On
Smoke/ Fire Alarm Status	BI 21	R	Smoke/ Fire Alarm Status	0: Off, 1: On
Status	BI 22	R	Current Status	0: Off, 1: On
Valve Status	BI 23	R	Valve Status	0: Off, 1: On
Alarm	BI 24	R	Alarm Status	0: Off, 1: On
Frozen Alarm Status	BI25	R	Frozen Alarm Status	0: Off, 1: On
After Hour Status	BI26	R	After Hour Status	0: Normal Hour 1: After Hour
Occupancy Contact Definition	BV 0	R/W	Occupancy (D1) Contact Definition	0: N.O.= Occupied 1: N.C. = Occupied
Cooling Direct-Reverse Acting	BV 1	R/W	Modulating Cooling Direct/Reverse Signal Output	0: Direct (0 To10v) 1: Reverse (10 To 0V)
Heating Direct-Reverse Acting	BV 1	R/W	Modulating Cooling Direct/Reverse Signal Output	0: Direct (0 To10v) 1: Reverse (10 To 0V)
Reversing Valve Polarity	BV 3	R/W	Reversing Valve Polarity	Cooling/Heating 0: N.O./ N.C. 1: N.C./ N.O.
Window-Door Contact Definition	BV 4	R/W	Door or Windows(DI2) Contact Definition	0: N.O. 1: N.C.
On-Off Control	BV 5	R/W	On/Off Status of Thermostat	0: Off, 1: On
Temperature Scale	BV 6	R/W	°C/ °F	0: °C 1: °F
Relay 1 Control	BV7	R/W	On/Off Control of Relay 1 (O/B Valve)	0: Off, 1: On
Relay 2 Control	BV8	R/W	On/Off Control of Relay 2 (Comp 1)	0: Off, 1: On

Object name	Type & Instance	Readable/Writable	Description	Range and Definition
Relay 3 Control	BV9	R/W	On/Off Control of Relay 3 (Comp 2)	0: Off, 1: On
Relay 4 Control	BV10	R/W	On/Off Control of Relay 4 (Heating Stage 3)	0: Off, 1: On
Relay 5 Control	BV11	R/W	On/Off Control of Relay 5	0: Off, 1: On
Relay 6 Control	BV12	R/W	On/Off Control of Relay 6	0: Off, 1: On
Relay 7 Control	BV13	R/W	On/Off Control of Relay 7 (Fan)	0: Off, 1: On
Occupancy Command	BV 14	R/W	Room Occupancy Setting	0: Occupied, 1: Unoccupied
Fan Output for Heating	BV15	R/W	Disable/ Enable Fan Output for Heating	0: Disable, 1: Enable
Heartbeat	BV16	R/W	Communication Heartbeat Flip-Flop	0: Disable, 1: Enable
Fan Mode	MSV 0	R/W	Fan Mode	1: Auto 2: Low 3: Med. 4: Hi
System Mode	MSV 1	R/W	Working Mode: Heat, Cool, or Ventilation	1: Cool Mode 2: Heat Mode 3: Ventilation @ Cool Mode 4: Ventilation @ Heat Mode
Sleep	MSV 2	R/W	Sleep (Only for Models with Sleep Function Available).	1: Disable 2: 0 Hr. Sleep 3: 0.5 Hr. Sleep 4: 1 Hr. Sleep 5: 1.5 Hrs. Sleep 6: 2 Hrs. Sleep
Temperature Source	MSV3	R/W	Current Temperature Source	1: Built-In Temp. Sensor 2: Remote Temp. Sensor 3: Assigned through BACnet
Lowest Fan Speed	MSV 4	R/W	Lowest Fan speed in Auto Fan mode	1: Stop 2: Low 3: Med. 4: Hi
Fan Speed Status	MSV 5	R	Fan Speed Status	1: Stop 2: Low 3: Med. 4: Hi
Baud Rate	MSV 6	R/W	Baud Rate (BPS for MS/TP)	1: 9600 bps 2: 19200 bps 3: 38400 bps 4: 57600 bps 5: 76800 bps
Display Options	MSV 7	R/W	LCD Display Options	1: T & Time (if available) 2: SP & Time (if available) 3: T & CO2 (if available) 4: CO2 & Time (if available) 5: SP & CO2 (if available) 6: T & RH (if available) 7: T & Valve (if available)

Object name	Type & Instance	Readable/Writable	Description	Range and Definition
Control Type	MSV 8	R/W	Control Type Selection	1: Cooling Only 2: Cooling or Heating Manual Changeover 3: Cooling and Heating Auto Changeover (default) 4: Heating Only NOTE: Cool only and Heat only types disabled

5 Warranty

Contemporary Controls (CC) warrants this product to the original purchaser for two years from the product shipping date. Product returned to CC for repair is warranted for one year from the date the repaired product is shipped back to the purchaser or for the remainder of the original warranty period, whichever is longer.

If the product fails to operate in compliance with its specification during the warranty period, CC will, at its option, repair or replace the product at no charge. The customer is, however, responsible for shipping the product; CC assumes no responsibility for the product until it is received.

CC's limited warranty covers products only as delivered and does not cover repair of products that have been damaged by abuse, accident, disaster, misuse, or incorrect installation. User modification may void the warranty if the product is damaged by the modification, in which case this warranty does not cover repair or replacement.

This warranty in no way warrants suitability of the product for any specific application. IN NO EVENT WILL CC BE LIABLE FOR ANY DAMAGES INCLUDING LOST PROFITS, LOST SAVINGS, OR OTHER INCIDENTAL OR CONSEQUENTIAL DAMAGES ARISING OUT OF THE USE OR INABILITY TO USE THE PRODUCT EVEN IF CC HAS BEEN ADVISED OF THE POSSIBILITY OF SUCH DAMAGES, OR FOR ANY CLAIM BY ANY PARTY OTHER THAN THE PURCHASER.

THE ABOVE WARRANTY IS IN LIEU OF ANY AND ALL OTHER WARRANTIES, EXPRESSED OR IMPLIED OR STATUTORY, INCLUDING THE WARRANTIES OF MERCHANTABILITY, FITNESS FOR PARTICULAR PURPOSE OR USE, TITLE AND NONINFRINGEMENT.

6 Returning Products for Repair

Return the product to the location where it was purchased or follow the instructions at the URL below:

www.ccontrols.com/rma.htm

7 Declaration of Conformity

Additional compliance documentation can be found on our website: www.ccontrols.com



United States	China	United Kingdom	Germany
Contemporary Control Systems, Inc.	Contemporary Controls (Suzhou) Co. Ltd	Contemporary Controls Ltd	Contemporary Controls GmbH
Tel: +1-630-963-7070 Fax: +1-630-963-0109	Tel: +86 512 68095866 Fax: +86 512 68093760	Tel: +44 (0)24 7641 3786 Fax: +44 (0)24 7641 3923	Tel: +49 341 520359 0 Fax: +49 341 520359 16
info@ccontrols.com	info@ccontrols.com.cn	ccl.info@ccontrols.com	ccg.info@ccontrols.com
www.ccontrols.com			

CONTEMPORARY CONTROLS®