

BASpi-Edge

12-Point Cloud Connected BACnet Edge Controllers

BASpi-Edge 6/6 and BASpi-Edge 6/4/2



BACnet™

Sedona



**Microsoft
Azure**

User Manual

UM-18050000-AA2

CONTEMPORARY CONTROLS®

Trademarks

BASautomation, Contemporary Controls, and CTRLink are registered trademarks of Contemporary Control Systems, Inc. BACnet is a registered trademark of the American Society of Heating, Refrigerating and Air-Conditioning Engineers, Inc. Other product names may be trademarks or registered trademarks of their respective companies.

Copyright

© Copyright 2023, by Contemporary Control Systems, Inc. All rights reserved. No part of this publication may be reproduced, transmitted, transcribed, stored in a retrieval system, or translated into any language or computer language, in any form or by any means, electronic, mechanical, magnetic, optical, chemical, manual, or otherwise, without the prior written permission of:

Contemporary Control Systems, Inc.	Tel:	+1-630-963-7070
2431 Curtiss Street	Fax:	+1-630-963-0109
Downers Grove, Illinois 60515 USA	E-mail:	info@ccontrols.com

Contemporary Controls Ltd	Tel:	+44 (0)24 7641 3786
United Kingdom	Fax:	+44 (0)24 7641 3923
	E-mail:	ccl.info@ccontrols.com

Contemporary Controls (Suzhou) Co. Ltd	Tel:	+86 512 6805866
	Fax:	+86 512 68093760
	E-mail:	info@ccontrols.com.cn

Contemporary Controls GmbH	Tel:	+49 (0)341 520359 0
Germany	Fax:	+49 (0)341 520359 16
	E-mail:	ccg.info@ccontrols.com

Disclaimer

Contemporary Control Systems, Inc. reserves the right to make changes in the specifications of the product described within this manual at any time without notice and without obligation of Contemporary Control Systems, Inc. to notify any person of such revision or change.

Contents

1	Introduction	6
1.1	Features and Benefits.....	6
1.2	Product Image and Main Features	8
2	Specifications.....	9
2.2	Networking.....	10
2.3	Universal Inputs (Channels UI1-UI6)	10
2.4	Binary Outputs (Channels BO1–BO6 or BO1–BO4 model dependent).....	11
2.5	Analog Outputs (Channels AO1 and AO2 on BASpi-Edge 6/4/2).....	11
2.6	Power	11
2.7	Display Interface.....	11
2.8	Serial Interface	12
2.9	Audio	12
3	Mechanical Dimensions, Mounting, and Power.....	13
3.1	BASpi-Edge 6/6 – 6 Universal Inputs and 6 Binary Outputs	13
3.2	BASpi-Edge 6/4/2 – 6 Universal Inputs, 4 Binary Outputs, and 2 Analog Outputs.....	13
3.3	Mounting.....	14
3.4	Power	15
4	Typical Wiring Diagrams.....	16
4.1	BASpi-Edge 6/6 – 6 Universal Inputs and 6 Binary Outputs	16
4.2	BASpi-Edge 6/4/2 – 6 Universal Inputs, 4 Binary Outputs, and 2 Analog Outputs.....	17
5	Controller Channel Configuration	18
5.1	Initial Setup and Restoring Defaults	18
5.1.1	Reset of IP Address and Login Credentials	19
5.2	Input/Output Configuration	20
5.2.1	Channel Type Configuration	21
5.2.1.1	Universal Inputs.....	21
5.2.1.2	Analog Input	23
5.2.1.3	Temperature or Resistance Input.....	24
5.2.1.4	Binary Input	27
5.2.1.5	Pulse Input.....	28
5.2.1.6	Analog Output (only available on BASpi-Edge 6/4/2).....	30
5.2.1.7	Binary Output Connections (4 or 6 binary outputs – model dependent).....	31
5.2.2	Analog and Binary Output Web Page Configuration	31

- 5.2.2.1 Analog Output 32
- 5.2.2.2 Binary Output 33
- 6 Controller System Configuration 34
- 6.1 System Configuration Page 34
- 6.1.1 Admin Tab 35
- 6.1.2 Wired Tab 35
- 6.1.3 Wi-Fi Tab..... 36
- 6.1.4 BACnet Tab – BACnet Configuration 38
- 6.1.4.1 Device Instance 38
- 6.1.4.2 Device Object 38
- 6.1.4.3 UDP Port 38
- 6.1.4.4 Broadcast Management Device (BBMD) 38
- 6.1.4.5 Time Transmission Interval 38
- 6.1.4.6 Interface 39
- 6.1.5 BACnet Tab - Client Configuration..... 39
- 6.1.5.1 Poll Delay 39
- 6.1.5.2 Retry Delay 40
- 6.1.6 BACnet Tab - Configure BACnet Servers..... 41
- 6.1.6.1 BACnet Discovery Tool for IP Devices..... 43
- 6.1.6.2 Configuring Routed BACnet MS/TP Server Devices..... 48
- 6.1.6.3 Configuring Routed BACnet non-MS/TP Server Devices 50
- 6.1.6.4 Configuring USB Dongle BACnet MS/TP Devices..... 51
- 6.1.7 The MSTP Tab..... 53
- 6.1.7.1 BACnet MS/TP Setup for EIA-485 to USB Dongle 53
- 6.1.7.2 MAC Address 53
- 6.1.7.3 Max Master Nodes 54
- 6.1.7.4 Max Info 54
- 6.1.7.5 Baud Rate 54
- 6.1.7.6 Tolerance 54
- 6.1.7.7 EIA-485 to USB Dongle for BACnet MS/TP Connection 54
- 6.1.8 Configuring BACnet Server Device Points..... 56
- 6.1.8.1 NetV Component..... 60
- 6.1.8.2 NETVAI4 Component 61
- 6.1.8.3 NETVAO4 Component 61

- 6.1.8.4 NETVAV4 Component..... 62
- 6.1.8.5 NETVBI4 Component..... 63
- 6.1.8.6 NETVBO4 Component 63
- 6.1.8.7 NETVBV4 Component..... 64
- 6.1.8.8 Examples 65
- 6.2 System Status Pages..... 67
 - 6.2.1 MS/TP Status 67
 - 6.2.2 Set Time..... 69
 - 6.2.3 Virtual Points 71
 - 6.2.3.1 Virtual points Web page..... 73
- 6.3 Web Components..... 75
- 6.4 Schedule 76
 - 6.4.1 Default Schedule 77
 - 6.4.2 Current Schedule 77
 - 6.4.3 Events 78
 - 6.4.3.1 New Event 80
 - 6.4.3.2 Adding Schedules to Sedona 83
 - 6.4.3.3 Basic Schedules 84
- 6.5 BACnet Utility 85
- 6.6 Azure IoT Central Cloud..... 87
 - 6.6.1 Overview 87
 - 6.6.2 Cloud Connection Benefits 88
 - 6.6.3 Establish an Account, Pricing and Quotas 88
 - 6.6.4 Establish Cloud Connection 90
 - 6.6.5 Cloud Personas 92
 - 6.6.6 Create your IoT Central application..... 94
 - 6.6.7 Customize the UI 94
 - 6.6.8 Manage your devices..... 95
 - 6.6.9 Dashboards..... 95
 - 6.6.10 Rules and actions..... 95
 - 6.6.11 Jobs..... 95
 - 6.6.12 Integrate with other services 95
 - 6.6.13 Build custom IoT solutions and integrations with the REST APIs 96
 - 6.6.14 Writing data from IoT Central to BASpi-Edge 96

6.7	Weather	98
6.7.1	Overview and Account	98
6.7.2	Establish Weather Server Connection	98
6.7.3	Assign Virtual Points	99
6.8	Email Configuration	103
6.8.1	Overview	103
6.8.2	Establish an Account	104
6.8.3	Creating Messages.....	106
6.8.4	Email Component Configuration	111
6.9	Restart Controller	113
7	Graphical Dashboard	113
7.1	Web-based Setup	114
7.1.1	Begin Dashboard Design.....	114
7.1.2	Add Data Source	115
7.1.3	Name Data Source	117
7.1.4	Dashboard Design	118
7.1.5	Choose Data Sources	121
7.1.6	Create a Widget Pane.....	123
7.1.7	Create Another Pane (Sparkline).....	125
7.1.8	Create Another Pane (Indicator)	126
7.1.9	Create Another Pane (Slider).....	127
7.1.10	Complete Dashboard Examples.....	129
7.2	HDMI Screen Setup	130
7.3	HDMI Touchscreen Human-Machine Interface Setup.....	132
8	Sedona.....	134
9	Software Tools.....	142
9.1	BAScontrol Toolset	142
9.2	Sedona Programming / Data Processing	142
9.3	Project Backup and Restore	143
9.4	BASpi-Edge Emulation	144
10	REST API.....	146

1 Introduction

The BASpi-Edge series are hardened controllers with enhanced features and data processing at the Edge functionality, powered by Raspberry Pi 3. Housed in a compact DIN rail mounted enclosure with 24 VAC/VDC power input and a resilient 8GB pSLC micro SD card gives them performance and convenience advantages, making them suitable for a wide array of applications. The two BASpi-Edge controller models only differ in the makeup of their outputs. The BASpi-Edge 6/6 has 6 universal inputs and 6 relay outputs. The BASpi-Edge 6/4/2 has 6 universal inputs, 4 relay outputs, and 2 analog outputs. BACnet/IP client/server communication over Ethernet or Wi-Fi, and Sedona function block programmable control and data processing at the Edge come standard. Optionally, BACnet MS/TP client/server communication can be accomplished using an EIA-485 to USB dongle (sold separately). BASpi-Edge are fully web page configurable with quick and easy cloud connectivity to Azure IoT Central (SaaS) hosted cloud platform solution. Additional features such as email alarms/notifications, schedules with holidays/exceptions, weather web service, as well as graphical dashboards served over Ethernet, Wi-Fi, or directly out of the resident HDMI port make the BASpi-Edge ideal for standalone or BACnet supervised automation applications. By leveraging open IoT protocols such as MQTT, proven security mechanisms such as Transport Layer Security (TLS), and the robust and easy to use software as a service (SaaS) cloud solution – Azure IoT Central, BASpi-Edge controllers can easily and securely connect to the cloud, effectively making any attached equipment a cloud connected asset. Cloud connectivity is optional, but it provides excellent global asset management and supervision capabilities in multi-site building applications, or multi-branch store or retail chains. Software tools for programming, archiving and emulation of BASpi-Edge controllers are provided for free in the BAScontrol Toolset.

1.1 Features and Benefits

- BACnet/IP client/server over 10/100 Mbps Ethernet or Wi-Fi connections (BACnet client limited to 5 devices/20 points)
- Optional BACnet MS/TP client/server node connection using an optional USB to EIA-485 dongle (USB to EIA-485 dongle sold separately, BACnet client limited to 5 devices/20 points)
- Resident Sedona Virtual Machine (SVM) with function block programming
- Web page configurable over Ethernet or Wi-Fi connections
- Advanced web page configurable schedules with events (holidays/exceptions)
- Email alarms/notifications with point values
- Weather web service with the free openweathermap.org weather server
- Secure connection to Azure IoT Central (SaaS) hosted cloud platform solution
- Customizable graphical dashboards served over Ethernet, Wi-Fi, or direct HDMI output
- Sunrise/sunset calculation based on geolocation
- NTP server, TimeSync or manually settable clock
- Free BAScontrol Toolset for programming, project archiving and emulation
 - Sedona Applications Editor (SAE) – function block programming editor
 - BASbackup – BASpi-Edge project backup/restore utility
 - BASemulator – BASpi-Edge controller emulation on PC for offline or remote programming
- Six configurable universal inputs: analog input (0–10 V or 0–20 mA with 500 Ω external resistor), binary input, resistance input (1 k Ω – 100 k Ω), thermistor input (10 kT2, 10 kT3, 20 k), pulse input (40 Hz max with retention to flash every 30min.)

- Four or six relay outputs (30 V @ 2 A max current) – model dependent
- Two or zero analog outputs (0–10 VDC @ 4 mA max current) – model dependent
- 48 Virtual Points (VT) communicate with BACnet clients and supervisory workstations
- 48 Web Components (WC) communicate with web browser for monitoring and configuration

1.2 Product Image and Main Features

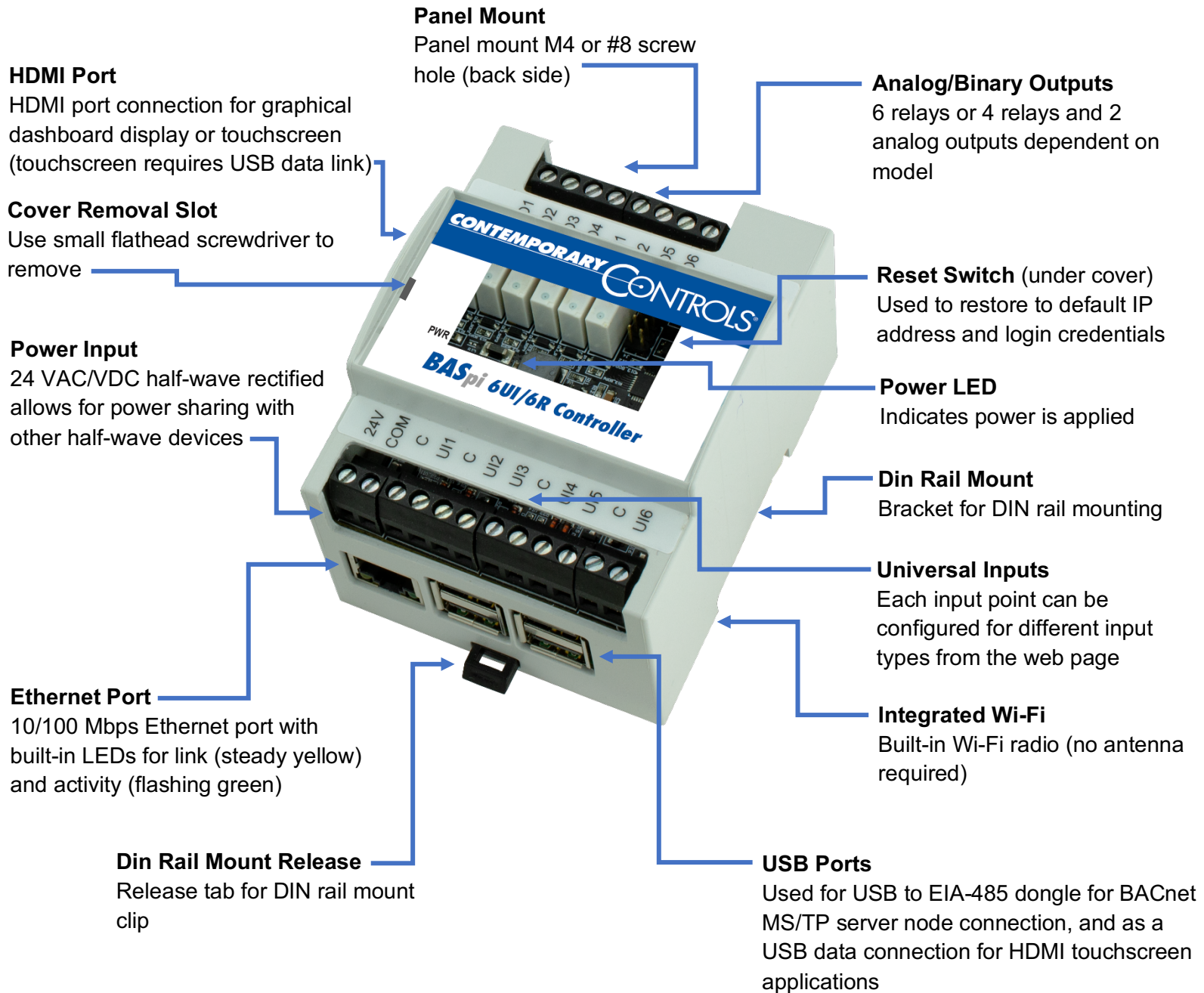

2 Specifications

The BASpi-Edge series of advanced controllers are powered by Raspberry Pi 3 inside, providing ample computing power and robust features with its 1.2 GHz quad-core ARM Cortex A53 (ARMv8) CPU and 1 GB of RAM memory. Built-in 10/100 Mbps Ethernet and Wi-Fi adapters provide fast and convenient IP connectivity for web server configuration, BACnet/IP connectivity, cloud connectivity, Sedona function block programming, and web-based graphical dashboards. The integrated Wi-Fi network adapter is capable of picking up wireless signal without the need for an external antenna – even through walls and other non-metallic obstructions. In addition, the powerful 400 MHz Broadcom VideoCore IV integrated graphics core allows for customizable graphical dashboards displayed directly out of the HDMI port to an LCD/LED screen for monitoring, or touchscreen for monitoring and/or control in human-machine interface (HMI) applications. The USB ports are used for an optional BACnet MS/TP client/server node connection using an EIA-485 to USB dongle, as well as for USB data connection in HDMI touchscreen HMI applications. Our field proven power input and I/O circuit with configurable universal inputs and a mix of binary and analog, or all binary outputs daughterboard is mounted on top of the Raspberry Pi 3 to provide a resilient interface to most standard automation control signals, as well as convenient 24 VAC/VDC power input. To increase resilience of the system, an industrial grade 8 GB pSLC micro SD card is used for storage. A momentary Reset switch can be accessed by removing the top cover using a small flathead screwdriver if resetting of the IP address and login credentials is necessary to access the unit. Large screw terminals allow for convenient wiring. The BASpi-Edge is housed in a compact (72 mm wide) DIN rail or panel mounted enclosure making it suitable for a variety of applications.

2.1 Computing

CPU	Broadcom BCM2837 SoC. Quad Core 1.2GHz 64bit high efficiency processor with 32kB Level 1 and 512kB Level 2 cache memory. ARM Cortex A53 (ARMv8) architecture. Aluminium heat sink installed for increased heat dissipation.
RAM	1GB LPDDR2 (900 MHz).
GPU	Broadcom VideoCore IV (400 MHz).
Storage	8 GB pSLC industrial grade micro SD card for maximum system stability. Pseudo SLC NAND flash (MLC in 1-bit/cell mode, medium trace geometry, 2 voltage states to represent 0 or 1).

2.2 Networking

Ethernet	ANSI/IEEE 802.3 10/100 Mbps Ethernet. 10BASE-T, 100BASE-TX, auto-negotiation of speed and duplex. Auto-MDIX. 100 m maximum segment length. Built-in amber LED for link and flashing green LED for network activity. Protocols Supported: BACnet/IP, SOX, HTTP, MQTT, TLS, REST, SSH, SFTP
Wi-Fi	Broadcom BCM43438 chip provides 2.4GHz IEEE 802.11b/g/n wireless. No external antenna required. Wi-Fi client mode only. Protocols Supported: BACnet/IP, SOX, HTTP, MQTT, TLS, REST, SSH, SFTP
EIA-485 (requires additional hardware sold separately)	EIA-485 to USB dongle with FTDI chip and field terminal connections allows BACnet MS/TP client/server node communication. Web page configurable parameters. Protocol Supported: BACnet MS/TP
Bluetooth	Broadcom BCM43438 chip provides Bluetooth 4.1 Classic, Bluetooth Low Energy. No external antenna required. Currently not used.

2.3 Universal Inputs (Channels UI1-UI6)

Configured As	Limits
Analog Input	0–10 VDC or 0–20 mA (with 500 Ω external resistor). 10-bit resolution. Input impedance 1 M Ω on voltage.
Temperature Input	Type II 10 k Ω thermistor –10° to +190° F (–23.3° to +87.8° C). Type III 10 k Ω thermistor –15° to +200° F (–26.1° to +93.3° C).

	20 k Ω thermistor +15° to +215° F (-9° to +101° C).
Binary Input	Contact Closure Input. Excitation current 0.5 mA. Open circuit voltage 12 VDC. Sensing threshold 3 VDC (low) and 7 VDC (high). Response time 20 ms.
Pulse Input	0–10 VDC for active output devices. 0–12 VDC for passive devices (configured for internal pull-up resistor). 40 Hz maximum input frequency with 50% duty cycle. Adjustable high and low thresholds. Retention of count to flash every 30min.
Resistance	1 k Ω -100 k Ω range.

2.4 Binary Outputs (Channels BO1–BO6 or BO1–BO4 model dependent)

Binary Output	Normally open relay contacts. 30 VAC/VDC 2 A (Class 2 circuits only - requires external power source).
---------------	--

2.5 Analog Outputs (Channels AO1 and AO2 on BASpi-Edge 6/4/2)

Analog Output	0–10 VDC. 10-bit resolution, 4 mA maximum output.
---------------	---

2.6 Power

Input Power	24 VAC/VDC \pm 10%, 47–63 Hz, 8 W/10 VA Green power LED visible through top cover on proper power input.
-------------	---

2.7 Display Interface

HDMI	HDMI Standard Type A port for screen or touchscreen (USB data connection also required for touchscreen) applications. WARNING: HDMI screen cannot be powered by BASpi USB ports and requires a separate power source. USB connection
------	---

	between BASpi and HDMI screen is only used as data connection in touchscreen applications.
--	--

2.8 Serial Interface

USB	<p>4x USB 2.0 Type A ports used for optional EIA-485 to USB dongle for BACnet MS/TP client/server node connection and USB data connection for HDMI port touchscreen/HMI applications.</p> <p>WARNING: BASpi-Edge USB ports are low current and cannot be used to power or charge any auxiliary devices. Attempting to power auxiliary devices from the USB ports could result in insufficient power for proper BASpi-Edge operation.</p>
CSI	Camera Serial Interface. Currently not used.
DSI	Display Serial Interface. Currently not used.

2.9 Audio

Audio-Video Jack	4-pole 3.5mm analogue stereo output and composite video port. Currently not used.
------------------	---

3 Mechanical Dimensions, Mounting, and Power

3.1 BASpi-Edge 6/6 – 6 Universal Inputs and 6 Binary Outputs

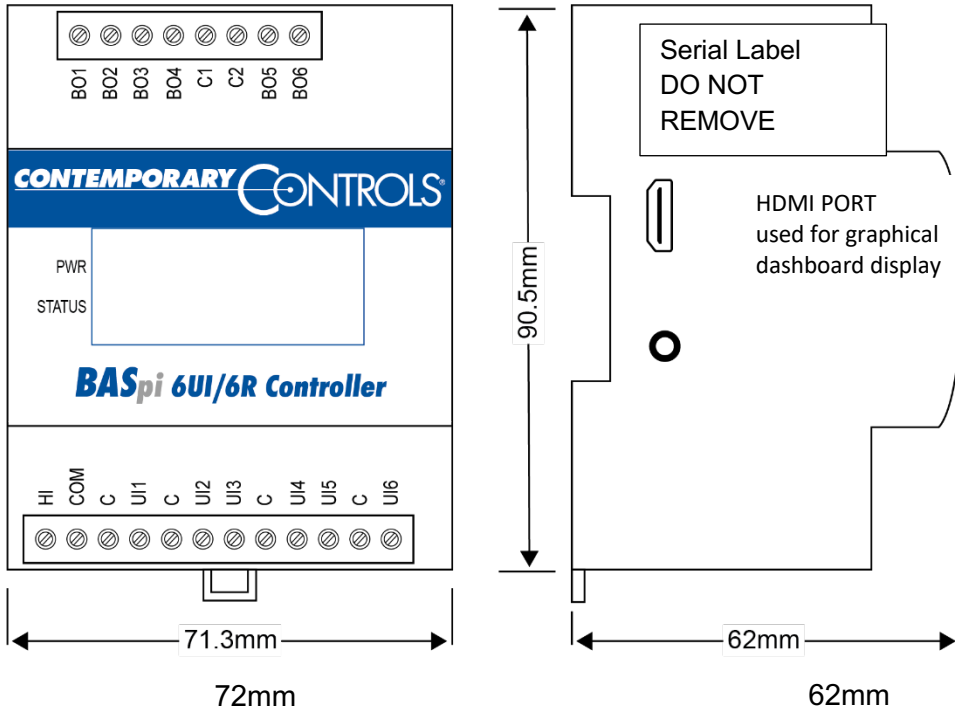

3.2 BASpi-Edge 6/4/2 – 6 Universal Inputs, 4 Binary Outputs, and 2 Analog Outputs

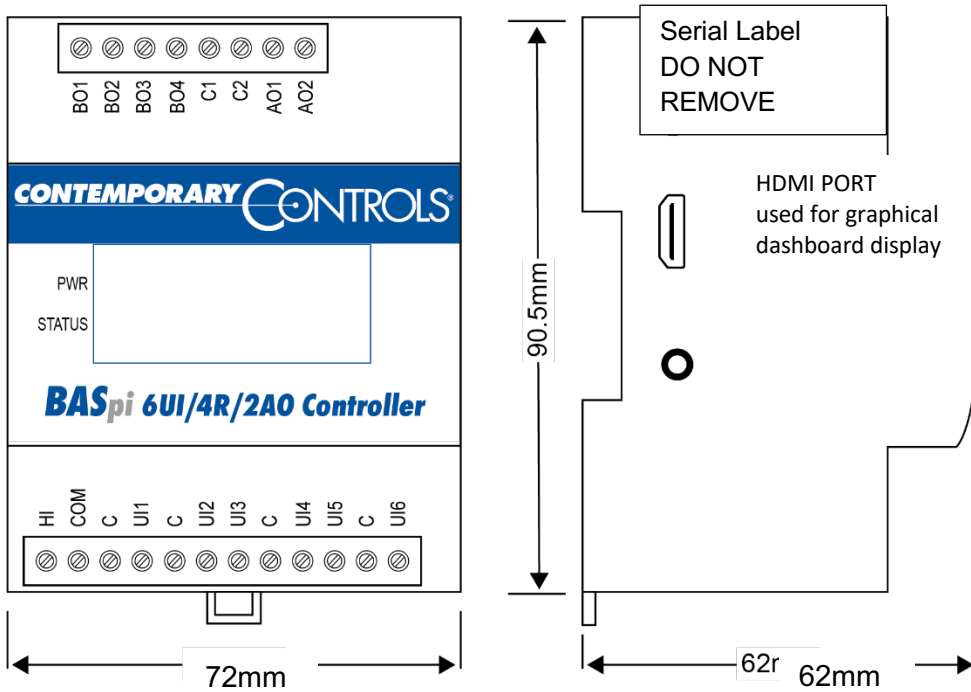

WARNING: Do not remove serial label or micro SD card or BASpi-Edge warranty will be voided.

3.3 Mounting

The BASpi-Edge 4M enclosure allows for DIN rail or panel mounting.

WARNING

To DIN rail mount, simply align and press against the DIN rail. To dismount, use a small flathead screwdriver to pry the DIN rail mount release tab down and pull the unit off the DIN rail.

To panel mount, align the mounting hole on the back of the unit to the screw on the panel (M4 or #8 screw) and slide down. To unmount, slide up and pull the unit off the panel.

For dimensions, refer to the drawing below.

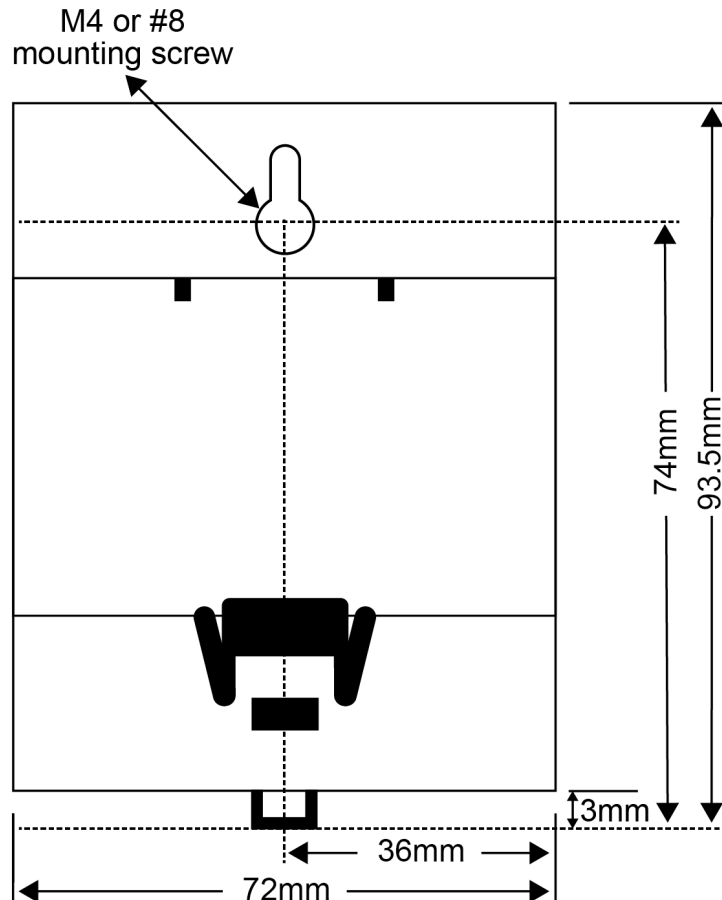

3.4 Power

The BASpi-Edge is 24 VAC/VDC powered through its 2-pin screw terminal while drawing no more than 8 W or 10 VA of power. The recommended conductor size is 16–18 AWG or up to 2x 1.5 mm wires.

WARNING: Internally, this device utilizes a half-wave rectifier and therefore can only share the same AC power source with other half-wave rectified devices. Sharing AC power with full wave rectified devices is NOT recommended. Devices powered from a common AC source could be damaged if a mix of half-wave and full wave rectified devices exists.

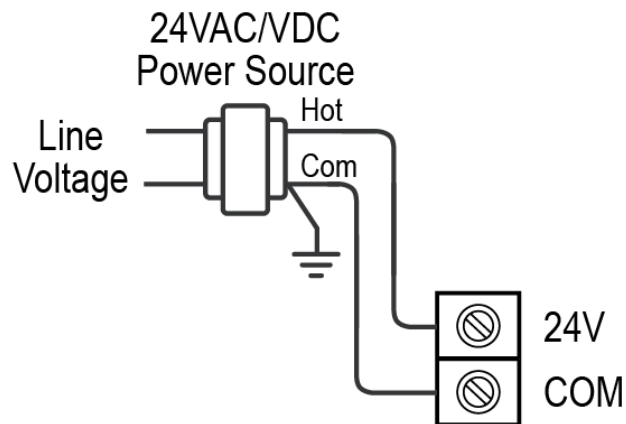

WARNING: BASpi-Edge cannot be powered using a 5 VDC power source through the Raspberry Pi micro USB input. Only use 24 VAC/VDC through the 2-pin screw terminal to power. The 5 VDC micro USB port is covered by the Serial label – do not remove this label or BASpi-Edge warranty will be voided.

WARNING: BASpi-Edge USB ports are low current and cannot be used to power or charge any auxiliary devices. Attempting to power auxiliary devices from the USB ports could result in insufficient power for proper BASpi-Edge operation. Only use as advised.

NOTE: Earth connection of power supply is required when communicating BACnet MS/TP to 2-wire devices not sharing a common power source, which should also have their Earth connections connected.

4 Typical Wiring Diagrams

4.1 BASpi-Edge 6/6 – 6 Universal Inputs and 6 Binary Outputs

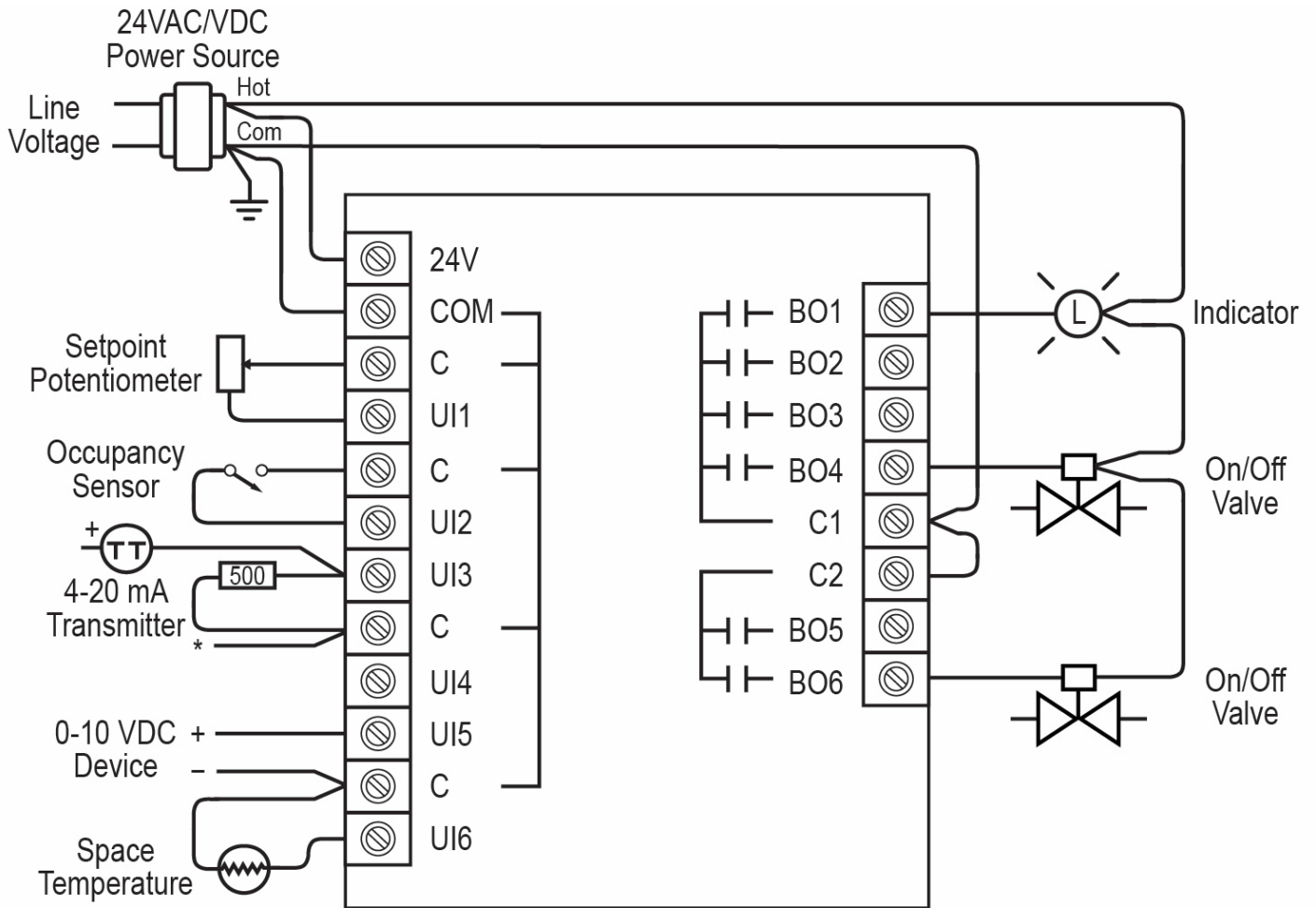

* – 4-20 mA loop power supply must be referenced to common (C)

4.2 BASpi-Edge 6/4/2 – 6 Universal Inputs, 4 Binary Outputs, and 2 Analog Outputs

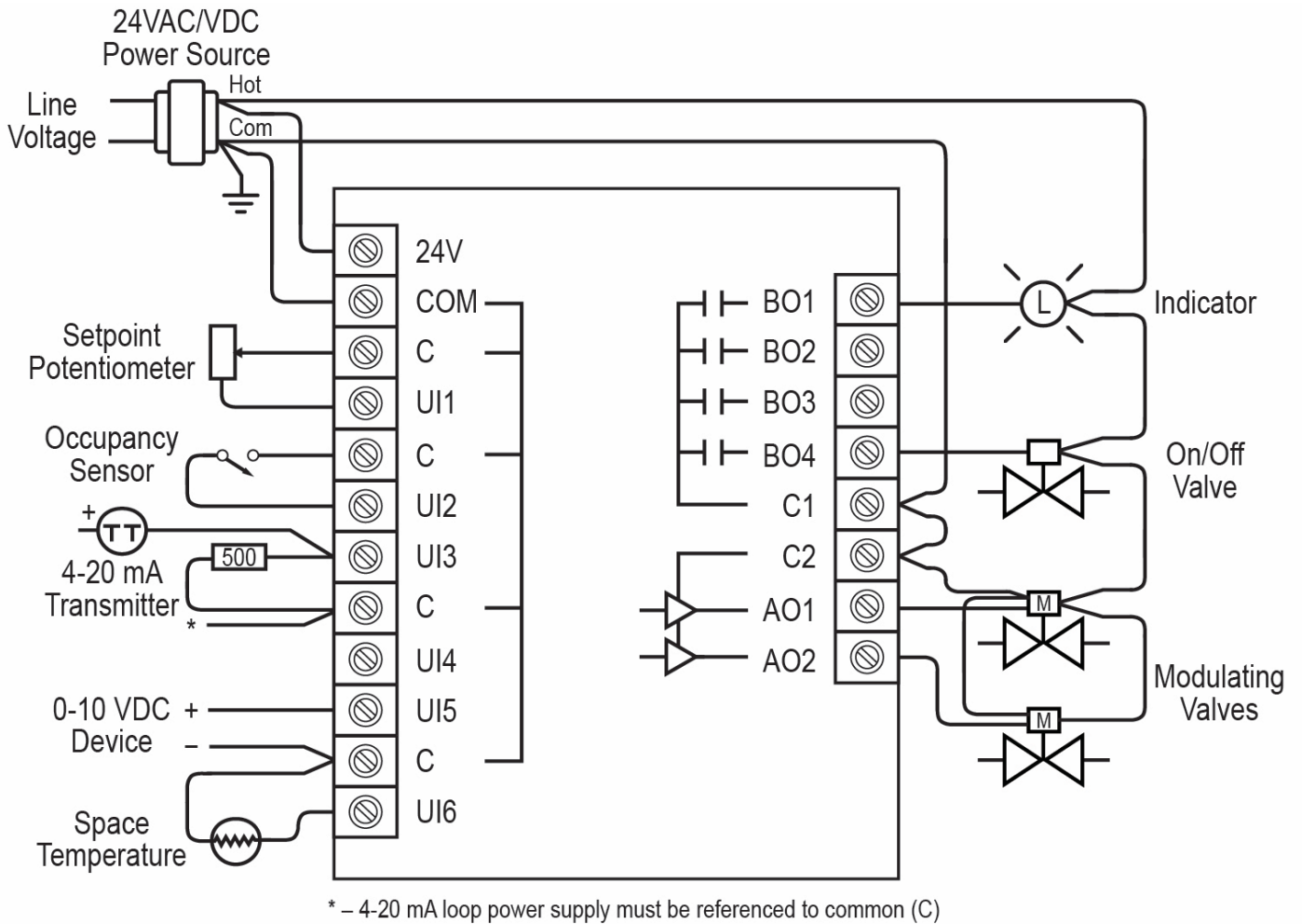

WARNING: C1 is a dedicated common for binary outputs BO1-BO4. C2 is a dedicated common for analog outputs AO1 and AO2. These common ground pins must be used accordingly to avoid damage to the circuit board.

5 Controller Channel Configuration

5.1 Initial Setup and Restoring Defaults

The BASpi-Edge is web page configurable and accessible from any PC with recent versions of most standard web browsers installed. Initially, the BASpi-Edge must be accessed over Ethernet at its default IP address because its Wi-Fi radio is disabled in its factory default condition. To configure, connect it to your PC using an Ethernet cable and set the PC's IP address and subnet mask to the same subnet as the BASpi-Edge.

Factory programmed:

IP Address: **192.168.92.68** Web server (HTTP) port: **80** (does not need to be typed in the browser)
Netmask: **255.255.255.0** Username: **admin**
Gateway: **192.168.92.1** Password: **admin**

ATTENTION: The default login password must be changed before the BASpi-Edge can be used or its system configuration altered. The password must be at least 8 characters long and it must contain at least one letter and one number. This ensures authorized access to the BASpi-Edge only.

To ensure secure access only, you must change the default password on first login. The default login credentials can only be used to login for the very first time and must be changed immediately after logging in. You will be presented with the Update Login web page shown below which will require you to set a new secure password. The password must be at least 8 characters long and must contain at least one letter and one number. Changing the username is optional, but highly recommended for enhanced security. Enter in the new credentials and click Update Login to continue.

CONTEMPORARY
CONTROLS®

Your BASpi-Edge 6/4/2 has an unsecure password.
The default password must be changed before you can continue.
This password must be at least 8 characters long and it must contain at least one letter and one number.

Username:

Password:

Confirm Password:

Confirm does not match

Password is too short

Once secure credentials are set, you will be asked to login again using the new secure credentials. The BASpi-Edge is now ready to configure and use.

5.1.1 Reset of IP Address and Login Credentials

In case you are not able to login to your BASpi-Edge due to unknown IP address or login credentials, remove the clear top cover with label to access the RESET momentary switch (pictured in diagram below). Using a small flathead screwdriver, pry the cover from the small side slot and lift to remove the cover.

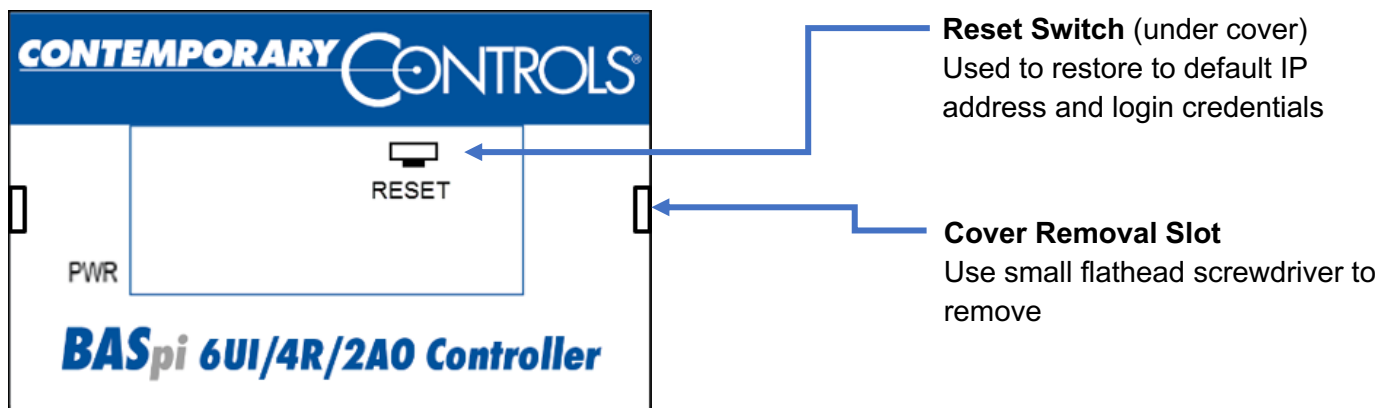

Using your finger, press and hold the RESET switch for 10 seconds – the Ethernet port LEDs will go off after holding it for 10 seconds. Release the RESET switch. Do not remove power from the unit. Wait 30 seconds for the unit to reboot on its own. The unit will be in recovery mode and accessible at its default IP address (192.168.92.68 /24) and login credentials (admin/admin).

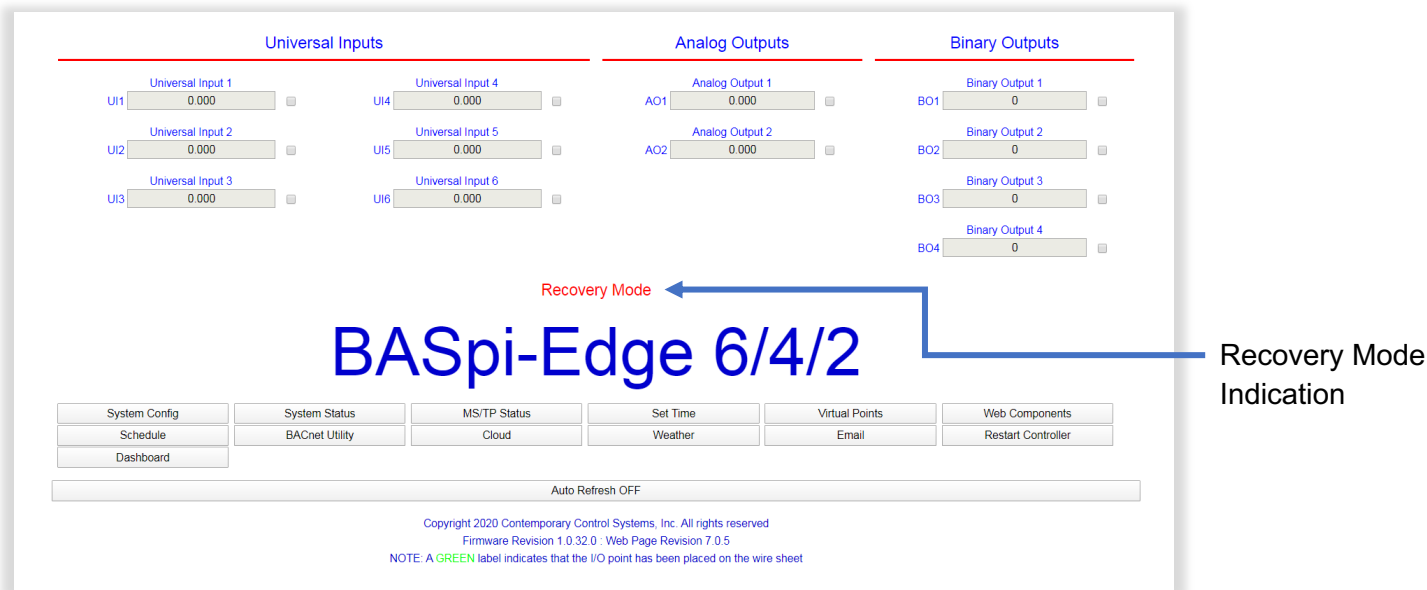

NOTE: The controller will not execute Sedona logic or communicate BACnet while in recovery mode. No configuration will be lost by performing the RESET procedure.

Login to the unit and open the System Configuration page. Your previously configured IP address and login credentials will still be shown in the page and will be used upon reboot if not changed. You can modify the configuration or leave it as is and take note of it. Once done, click the Restart Controller button on the main web page to reboot into normal operation using the configuration shown in the System Configuration web page. The unit will be accessible at the specified address and credentials after reboot.

5.2 Input/Output Configuration

The BASpi-Edge is web page configurable over wired 10/100 Mbps Ethernet connection, or wirelessly over Wi-Fi. Initially, the BASpi-Edge must be accessed over the Ethernet connection at its default IP address because its Wi-Fi radio is disabled in its factory default condition.

The main web page allows for easy system and channel type configuration, live monitoring, and forcing of physical I/O channels, virtual points, and web components. The main web page provides an overview of all physical I/O channels in addition to access buttons to all other configuration web pages.

To observe live updated data for all I/O channels, click the Auto Refresh button to ON state. Its default state is Auto Refresh OFF. Input and/or output channel values can be temporarily or permanently forced by checking the box adjacent to the channel(s) of interest, entering a value into the text box and clicking outside the box. The value will remain forced on the channel until the box is unchecked, or the unit rebooted. To retain forces on channels through reboot or power loss, click the Restart Controller button or right-click and choose Save Configurations to save the forced channel values into memory – this will cause the forced channels to remain forced even if the unit is power cycled or rebooted. Care must be exercised when forcing values into I/O channels because the value will be applied to the physical channel immediately after clicking away from the

The screenshot displays the BASpi-Edge 6/4/2 web interface. At the top, there are three main sections: Universal Inputs, Analog Outputs, and Binary Outputs. Each section contains a list of channels with their current values and checkboxes for forcing them.

Universal Inputs		Analog Outputs		Binary Outputs	
UI1	0.000	UI4	0.000	BO1	0
UI2	0.000	UI5	0.000	BO2	0
UI3	0.000	UI6	0.000	BO3	0
				BO4	0

BASpi-Edge 6/4/2

System Config	System Status	MS/TP Status	Set Time	Virtual Points	Web Components
Schedule	BACnet Utility	Cloud	Weather	Email	Restart Controller
Dashboard					

Auto Refresh OFF

Copyright 2020 Contemporary Control Systems, Inc. All rights reserved
 Firmware Revision 1.0.31.6 : Web Page Revision 7.0.5
 NOTE: A GREEN label indicates that the I/O point has been placed on the wire sheet

value box. These web page I/O overrides take the highest priority and will override physical inputs, Sedona logic, and BACnet commanded values for a given channel.

Points displayed in blue (default) on the web page are not being utilized in the Sedona wire sheet. Once a point is utilized in the Sedona wire sheet, its label is displayed in green to indicate the channel is used in Sedona wire sheet logic.

5.2.1 Channel Type Configuration

To configure an I/O channel, click on its point name on the Main Web Page and a Channel Configuration page will open. Examples of each channel type - Universal Input, Analog Output, and Binary Output are shown below.

5.2.1.1 Universal Inputs

For Universal Input channels, the Channel Type can be configured for: analog input (0–10 V), binary input, resistance input (1 kΩ – 100 kΩ), thermistor input (10 kT2, 10 kT3, or 20 k), pulse input (40 Hz max with retention to flash every 30min). Choose an input type from the Channel Type dropdown menu.

BAS Channel Configuration

Channel Type Analog Input ▼

Analog Input

Binary Input

Therm 10KT2

Therm 10KT3

Therm 20K

Resistance

Pulse Input

U11

BACnet Object Configuration

Object Instance 1

Object Name Universal Input 1

Object Type Analog Input ▼

Object Description Universal Input 1

Units VOLTS ▼

COV Increment 0

CloseSubmit

Object Name, Object Description, and Units can also be configured in the channel configuration page. These values are served over BACnet to clients and supervisors and used in the Azure IoT Central cloud setup.

Object Instance is the BACnet object instance which is not configurable – it is automatically assigned.

The BACnet COV Increment (Change of Value) can be set for each point at the bottom of the channel configuration page. COV Increment is the change of value increment used by BACnet clients/supervisors which support this service. COV only reports changes in value instead of continuously serving the point value (polled). COV can be useful to mitigate traffic on the network or conserve point trend database space in BACnet supervisory devices. All 12 BASpi-Edge physical I/O channels and 48 Virtual Points support COV. For analog points, "0" COV increment means that an analog point will be transmitting its value for any change in its value. COV increment does not apply to binary points and is therefore greyed out on those channels. You do not need to set up COV unless the BACnet client you are using supports this BACnet service.

Units dropdown allows you to specify the units for the channel value. To configure channel units, click on the Units dropdown and select a unit for the point.

BAS Channel Configuration

Channel Type Analog Input ▼

U11

Object Instance

Object Name

Object Type

Object Description

Units

DAY

DEGREES_ANGULAR

DEGREES_CELSIUS

DEGREES_CELSIUS_PER_HOUR

DEGREES_CELSIUS_PER_MINUTE

DEGREES_FAHRENHEIT

DEGREES_FAHRENHEIT_PER_HOUR

DEGREES_FAHRENHEIT_PER_MINUTE

DEGREES_KELVIN

DEGREES_PHASE

DEGREE_DAYS_CELSIUS

DEGREE_DAYS_FAHRENHEIT

DELTA_DEGREES_FAHRENHEIT

DELTA_DEGREES_KELVIN

FARADS

FEET

FEET_PER_MINUTE

FEET_PER_SECOND

FOOT_CANDLES

FURLONGS_PER_FORTNIGHT

Object Name

Object Description

Units ▼

Object Name

Object Description

Units

COV Increment 0

Close

Submit

5.2.1.2 Analog Input

An analog input can measure voltage in the range of 0–10 VDC or it can measure current in the range of 0–20 mA with a 500 Ω external resistor installed. Transmitters that produce an elevated “zero” such as 2–10 VDC or 4–20 mA can be measured as well. Using the web page, configure the input for voltage by selecting Analog Input. When set as a voltage input, the input impedance is 1 M Ω . With voltage measurement, connect the more positive voltage to point UIx (any UI channel) and the less positive to common C. On proportional damper actuators, the output signal is referenced to the damper’s power supply common. That common must be at the same reference as the BASpi-Edge common.

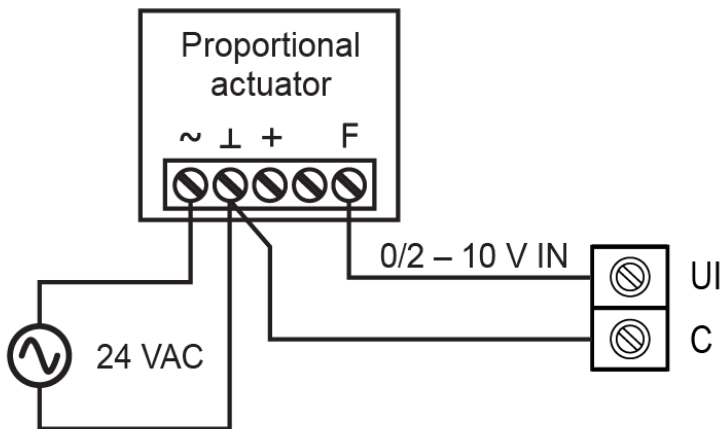

When measuring current from two-wire transmitters, remember the BASpi-Edge sinks current to ground. A 500 Ω external resistor must be applied between points UIx and C on the input. To measure current, it must be driven into point UIx with respect to point C.

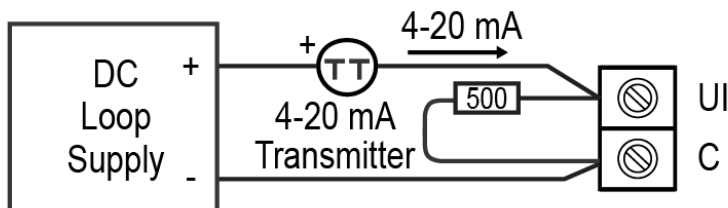

Care should be exercised when connecting to a three-wire current transmitter. These are usually non-isolated devices between the power source and signal output. The BASpi-Edge will sink current from its input to ground so the transmitter must source current from a positive potential to ground. If the three-wire transmitter works in this manner, it can be accommodated. Four-wire transmitters usually have isolation between power supply and signal output so their output stage can usually be treated as a two-wire transmitter.

BAS Channel Configuration

Channel Type

UI1

BACnet Object Configuration

Object Instance

Object Name

Object Type

Object Description

Units

COV Increment

5.2.1.3 Temperature or Resistance Input

The BASpi-Edge has built-in calibration curves for 10 k Ω Type II or Type III thermistors and 20 k Ω thermistors. These devices have a non-linear negative coefficient of resistance to temperature and provide a nominal resistance of 10 k Ω or 20 k Ω at 25° C. Using a web browser, configure an input Channel Type for either Type II or Type III thermistor or 20 k Ω . Connect the two-wire thermistor to points UIx and C. Polarity is not an issue. If averaging of temperature is desired, connect multiple thermistors in a series-parallel combination as shown below so that the nominal resistance remains at 10 k Ω or 20 k Ω . Make sure that all devices are of the same type. The effective range of measurement varies by type. Type II 10 k Ω thermistors range from -10° to +190° F (-23.3° to +87.8° C). Type III 10 k Ω thermistors range from -15° to +200° F (- 26.1° to +93.3° C). 20 k Ω thermistors range from 15° to 215° F (-9° to +101° C). An open input results in a fault condition for that point, however and out of bounds value can be set up.

Two-wire potentiometers used as setpoint stations can be read by the universal input by selecting resistance on the drop-down menu. The resistance range is from 1 k Ω to 100 k Ω . Connections are made just like thermistors, but no non-linear curves are used during resistance measurement. If unique curve-fitting is required, this could be accomplished using the Linearize Sedona component on the wire sheet. For example, a 3 k Ω thermistor can be used to sense a wider range of temperatures (such as outdoor temperature) and its curve can be fitted to the Linearize Sedona component on the wire sheet.

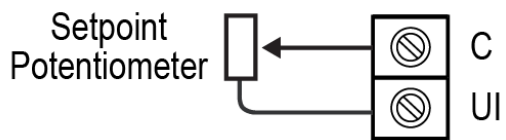
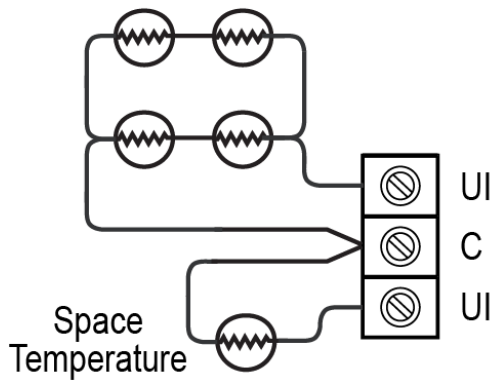

When a Universal Input channel is configured for one of the available thermistor curves (10 kT2, 10 kT3, or 20 k), several additional parameters are revealed. A Temperature Offset can be configured to offset/adjust the actual sensor reading by entering a positive or negative offset value in the box.

Temperature Units can be set for Fahrenheit or Celsius curves.

The Out of Bounds Value is the value which will be used for the channel by Sedona wire sheet logic, BACnet server, graphical dashboards and Azure Cloud in case the attached thermistor provides an out of bounds value such as in sensor failure or open circuit condition. The Out of Bounds Value can be very useful to maintain stable control logic operation until a repair can be performed.

BAS Channel Configuration

UI1

Channel Type

Temperature Offset

Temperature Units Out of Bounds Value

BACnet Object Configuration

Object Instance

Object Name

Object Type

Object Description

Units

COV Increment

BAS Channel Configuration

UI2

Channel Type

Open Circuit Value

BACnet Object Configuration

Object Instance

Object Name

Object Type

Object Description

Units

COV Increment

5.2.1.4 Binary Input

To sense the action of a push-button or relay, the contacts must have no applied energy, and be rated for low-voltage, low-current switching. The BASpi-Edge provides the energy to be sensed. Set the Channel Type to Binary Input and the Units to NO_UNITS. Connect the contacts between points UIx and C. For common mechanical contacts, polarity is not an issue.

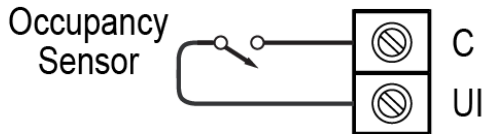

The open-circuit voltage is 12 VDC and the short-circuit current is 0.5 mA. For solid-state switch sensing, it is recommended that an attached solid-state device have an opt isolated open-collector NPN transistor output stage with a collector-emitter output voltage (V_{ce}) of at least 30 V. Output sinking current should be greater than 5 mA. The collector-emitter saturation voltage should be less than 0.2 V when sinking 2 mA. The emitter must be connected to point C and the collector to point UIx (the more positive point). The BASpi-Edge sets the low threshold to 3 V and the high-threshold to 6 V. When a contact is made or the solid-state switch is on (resulting in a saturated output), the voltage at point UIx is close to zero volts. If the contact is opened or the solid-state switch is turned off, the voltage at point C quickly rises towards 12 V. Once the voltage passes the 6 V high threshold, the “off” state is sensed. To return to the “on” state, this voltage must fall below 3 V. The three-volt difference is called hysteresis. There is no need to add an external pull-up resistor when using a contact closure input. Contact closure inputs are sampled every 10 ms and for a change of state to be recognized, the input state must be stable for two consecutive samples. Therefore, contact closure response is 20 ms.

BAS Channel Configuration

Channel Type

UI2

BACnet Object Configuration

Object Instance

Object Name

Object Type

Object Description

Units

COV Increment

5.2.1.5 Pulse Input

When an input is configured for Pulse Input, pulse rate up to 40 Hz can be measured, assuming a 50% duty cycle. The pulse device could have an active output or a passive output requiring a pull-up resistor. Both situations can be accommodated. The input voltage range is 0–10 VDC and the installer can set both the low-threshold and high threshold on the Pulse Input web page. The difference in the two thresholds is the hysteresis. You can detect a sinusoidal input by setting the high threshold below the positive peak and the low threshold above the negative peak. Setting both thresholds well away from the sinusoidal waveform peaks offers some noise immunity. It is not necessary for the input to swing from zero to 10 V. Any substantial swing within this range can be detected. The input impedance using Pulse Input is 100 k Ω when using active sensors. Connect the output of the pulse device to point UIx and the common to point C. If the pulse device has a passive output requiring a pull-up resistor, the BASpi-Edge can provide a 10 k Ω pull up resistor to +12 VDC by selecting Pull Up Resistor from the dropdown on the configuration page. The two threshold values can still be set as needed. Retention of pulse count is stored to flash every 30min.

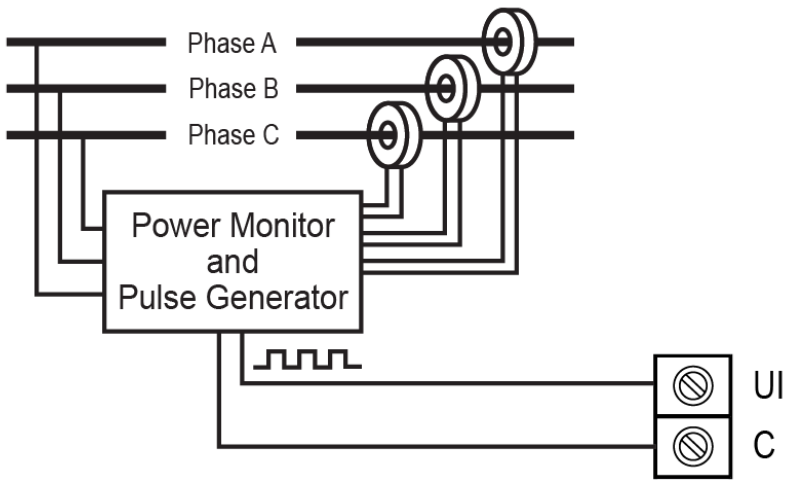

When a Universal Input channel is configured for Pulse Input, several additional configuration parameters are revealed.

Adjustable High and Low Thresholds are configurable in the respective fields.

Maximum Value (16777215 set by default) is the value at which the pulse count will roll over. A Universal Counter (UC) component in the Sedona wire sheet can be used to store roll over counts – these components' values are stored to flash memory every 30 minutes. To enable/disable the pull up resistor, use the Pull Up Resistor dropdown selection.

BAS Channel Configuration

Channel Type	<input type="text" value="Pulse Input"/>	
Maximum Value	<input type="text" value="16777215"/>	High Threshold <input type="text" value="7.5"/>
Pull Up Resistor	<input type="text" value="Enabled"/>	Low Threshold <input type="text" value="2.5"/>

UI3

BACnet Object Configuration

Object Instance	<input type="text" value="3"/>	
Object Name	<input type="text" value="Universal Input 3"/>	
Object Type	<input type="text" value="Analog Input"/>	
Object Description	<input type="text" value="Universal Input 3"/>	
Units	<input type="text" value="NO_UNITS"/>	
COV Increment	<input type="text" value="0"/>	<input type="button" value="Close"/> <input type="button" value="Submit"/>

5.2.1.6 Analog Output (only available on BASpi-Edge 6/4/2)

Voltage in the range of 0–10 VDC can be output by assigning analog outputs AO1 and AO2 (only available on BASpi-Edge 6/4/2). For analog output DC voltage, the output voltage is applied to point AO1 or AO2 with respect to C2 (common). There is no configuration necessary for analog outputs. C2 must be used as the common point for both AO1 and AO2 outputs on BASpi-Edge 6/4/2.

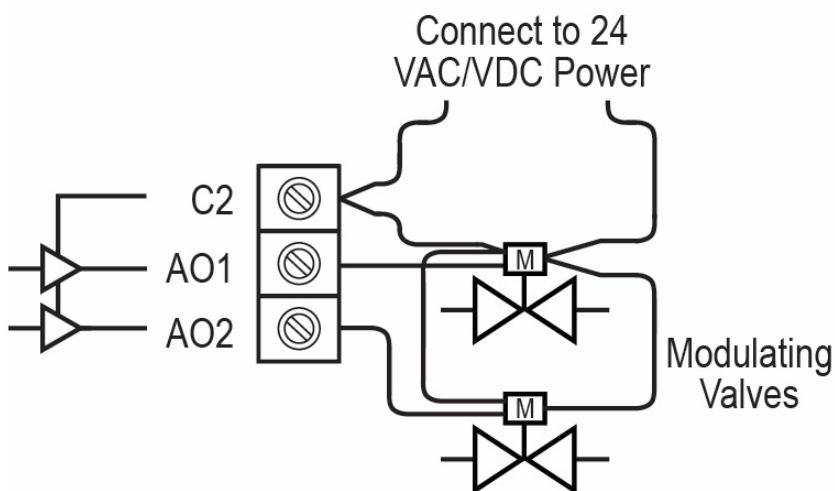

5.2.1.7 Binary Output Connections (4 or 6 binary outputs – model dependent)

Four (BASpi-Edge 6/4/2) or six (BASpi-Edge 6/6) binary outputs are available. Each output requires an external power source. Two types of binary devices can be controlled. The BASpi-Edge provides normally open form “A” relay contacts that are rated at 30 VAC/VDC and 2 A max current. Each binary output relay point BO1 through BO4 is engaged (shorted) or disengaged (opened) with respect to point C1 (BASpi-Edge 6/4/2). Each binary output relay point BO1 through BO4 is engaged (shorted) or disengaged (opened) with respect to point C1, BO5 and/or BO6 points are engaged (shorted) or disengaged (opened) with respect to point C2 (BASpi-Edge 6/6). Binary outputs are intended for Class 2 circuits only. BASpi-Edge 6/6 diagram shown below.

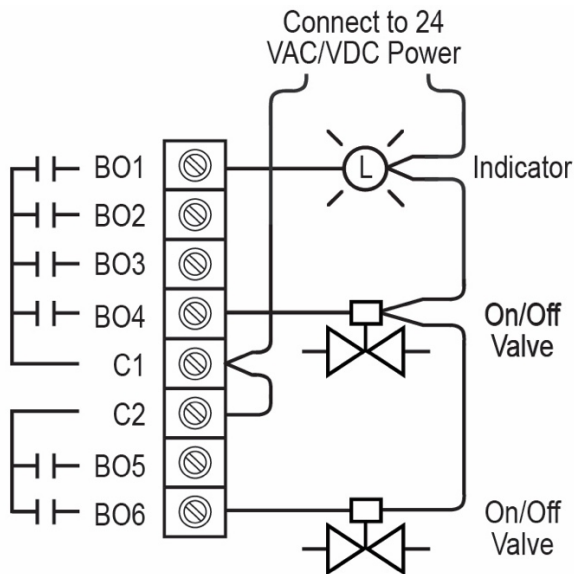

5.2.2 Analog and Binary Output Web Page Configuration

Analog and binary output channels have a fixed Channel Type of analog or binary respectively. These output channels also support Object Name, Object Description, and Units configuration in their channel configuration page. These values are served over BACnet to clients and supervisors, graphical dashboards, and used in the Azure IoT Central cloud setup.

A Default Value can be set for each output channel. This is the normal output value the controller will use as a starting control value in the case of power loss before a BACnet client has written to the channel or Sedona logic had been triggered. This Default Value is also the Relinquish Default value outside of the BACnet priority array used when no other higher priority (1 – 16) writes are present. As soon as Sedona logic or a BACnet client write to the point, Default Value is no longer used by the output.

The BACnet COV Increment (Change of Value) can be set for each point at the bottom of the channel configuration page. COV Increment is the change of value increment used by BACnet clients/supervisors which support this service. COV only reports changes in value instead of continuously serving the point value. COV can be useful to mitigate traffic on the network or conserve point trend database space in BACnet supervisory devices. All 12 BASpi-Edge physical I/O channels and 48 Virtual Points support COV. For analog points, “0” COV increment means that an analog point will be transmitting its value for any change in its value.

COV increment does not apply to binary points and is therefore greyed out on those channels. You do not need to set up COV unless the BACnet client you are using supports this BACnet service.

Units dropdown allows you to specify the units for the channel value. To configure channel units, click on the Units dropdown and select a unit for the point.

5.2.2.1 Analog Output

BAS Channel Configuration

Channel Type

Default Value

AO1

BACnet Object Configuration

Object Instance

Object Name

Object Type

Object Description

Units

COV Increment

5.2.2.2 Binary Output

BAS Channel Configuration

Channel Type

Default Value

BO1

BACnet Object Configuration

Object Instance

Object Name

Object Type

Object Description

Units

COV Increment

When finished making changes to the Channel Configuration, click the Submit button to apply changes, then click the Close button to close the channel configuration page. Restart of the unit is not required when altering channel configuration.

6 Controller System Configuration

The controller I/O has been configured using the main web page as outlined above. Located near the bottom of the main web page are a series of 13 access buttons to all other configuration web pages.

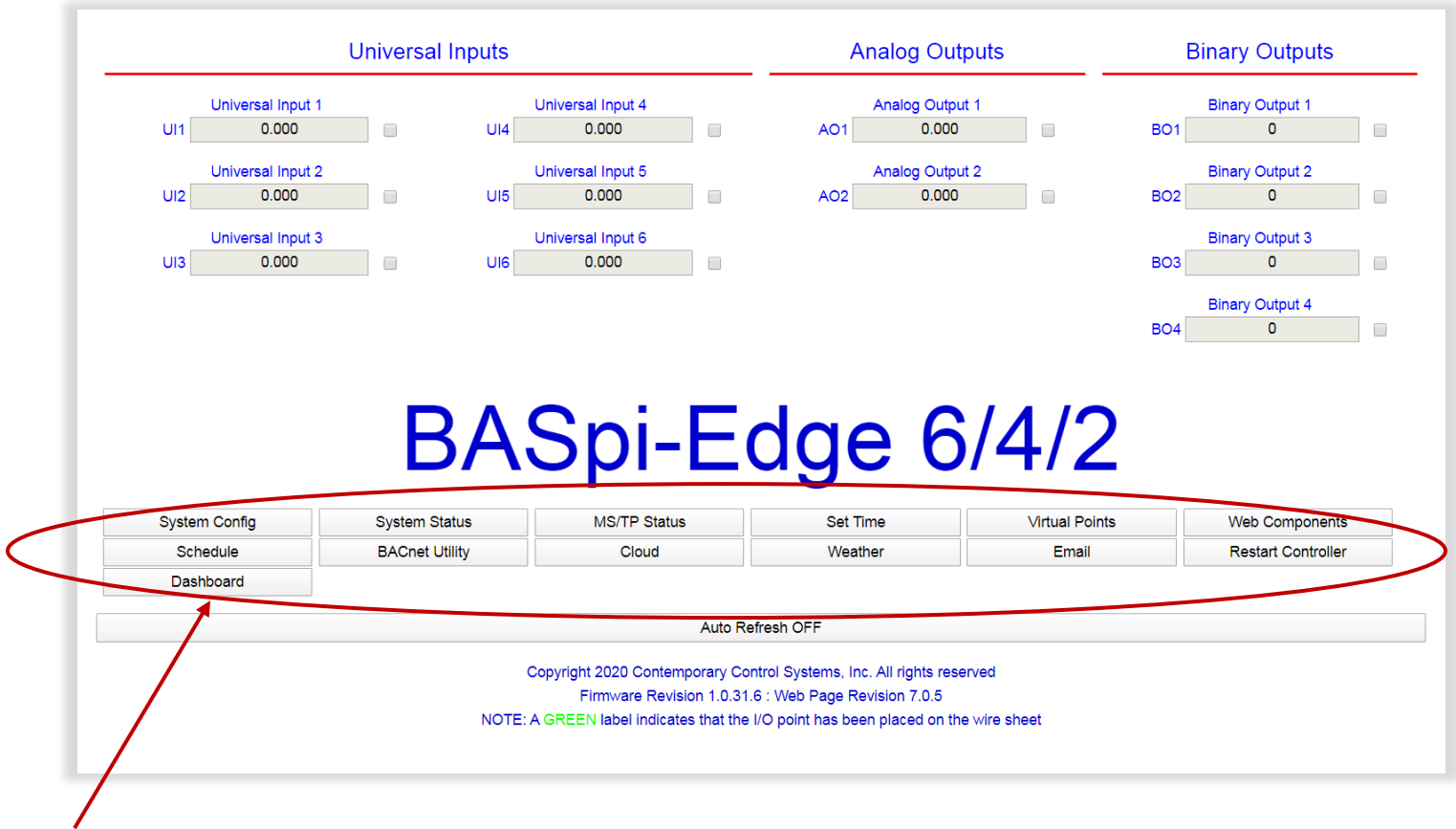

Access Buttons

6.1 System Configuration Page

The System Configuration page allows you to easily set up the Ethernet and Wi-Fi network adapters, enable/disable supported protocols, BACnet client/server configuration, optional BACnet MS/TP USB dongle configuration, and Admin login credentials. The System Configuration Page is divided into a few tabs selectable at the top of the page to make navigation easier. The Submit button must be clicked to apply any changes. Changes to this page will not take effect until the unit has been restarted. BASpi-Edge firmware can be restarted using the Restart Controller button on the main web page.

NOTE: The BASpi-Edge can operate on both Ethernet and Wi-Fi network adapters concurrently with the exception of the BACnet/IP client/server which will only operate on the selected IP network adapter in the

Interface dropdown under the BACnet tab. Only one of the two adapters (Ethernet or Wi-Fi) should have a gateway address to the Internet set up.

6.1.1 Admin Tab

The Admin tab contains the enable/disable protocols supported checkmarks and login credentials configuration. BACnet/IP checkmark enables the BACnet /IP server (enabled by default). BACnet Client checkmark enables the BACnet client (disabled by default), BACnet MS/TP checkmark enables BACnet MS/TP driver for optional EIA-485 to USB dongle (disabled by default), and the Sedona checkmark enables the Sedona Virtual Machine which executes wire sheet logic (enabled by default). Click Submit to apply changes. Changes will not take effect until the unit is restarted.

The screenshot shows a web interface for the 'Admin' tab. At the top, there is a navigation bar with tabs for 'Admin' (highlighted in red), 'Wired', 'Wi-Fi', 'BACnet', and 'MSTP'. On the right side of this bar are 'Close' and 'Submit' buttons. Below the navigation bar, the section is titled 'Enable Protocol' in blue text. Under this title, there are four checkmarks: 'BACnet/IP' (checked), 'BACnet MS/TP' (unchecked), 'BACnet Client' (unchecked), and 'Sedona' (checked). Below this, the section is titled 'Authentication' in blue text. Under this title, there are three input fields: 'User Name' with the value 'admin', 'Password' with a masked value '.....', and 'Confirm' with a masked value '.....'.

6.1.2 Wired Tab

The Wired tab is where the Ethernet network adapter configuration can be accessed. Either DHCP or a static IP address can be selected in IP Mode dropdown. If a static address is desired, enter the value along with the network mask and gateway address (only one gateway address should be set up on either Ethernet or Wi-Fi adapters). If a Domain Name Server address is required for Internet services such as NTP time service, Weather service, Cloud service, or Email alarms/notifications, enter in the Primary and Secondary DNS addresses. Click Submit to apply changes. Changes will not take effect until the unit is restarted.

Admin

Wired

Wi-Fi

BACnet

MSTP

Close

Submit

IP Configuration

IP Mode	STATIC
Address	192.168.92.68
Netmask	255.255.255.0
Gateway	0.0.0.0

DNS Configuration

DNS1	8.8.8.8
DNS2	8.8.4.4

6.1.3 Wi-Fi Tab

The Wi-Fi tab is where the Wi-Fi adapter configuration can be accessed. Either DHCP or a static IP address can be selected in IP Mode dropdown. If a static address is desired, enter the value along with the network mask and gateway address (only one gateway address should be set up on either Ethernet or Wi-Fi adapters). Enter the SSID of the Wi-Fi access point and the associated password to connect. Click Submit to apply changes. Changes will not take effect until the unit is restarted.

Wi-Fi Configuration

IP Mode	OFF
Address	192.168.92.67
Netmask	255.255.255.0
Gateway	0.0.0.0
SSID	none
Password

NOTE: Static IP addressing is advisable when the BASpi-Edge is used as a BACnet server to other BACnet client device(s) on the network. Dynamic Host Configuration Protocol (DHCP) is a service running on devices such as IP routers or servers on the local IP network. Dynamic IP addresses are issued to devices on the network using a periodic leasing system, meaning that the leased IP address is only active for a limited time. If the lease time expires, the BASpi-Edge will automatically request a new lease from the DHCP server. Sometimes, this means the BASpi-Edge could receive a new IP address if the controller was disconnected/unplugged from the IP network or had lost power between leases. As a BACnet server device on the network, it is recommended to assign the BASpi-Edge a Static IP address, in order to ensure stable communication in the long run. Static IP addresses are fixed and do not change unless you change them manually. Static IP is selected by default in IP Mode drop-down selection on the System Configuration web page for both network adapters. If BASpi-Edge is used a BACnet client device only, static IP addressing is not a concern as BACnet clients can change their IP addresses without affecting BACnet client – server communication.

6.1.4 BACnet Tab – BACnet Configuration

The BASpi-Edge is BACnet/IP connected over Ethernet or Wi-Fi connections as well as an optional BACnet MS/TP connection by using an EIA-485 to USB dongle (sold separately). BACnet device settings must be configured when using BACnet.

6.1.4.1 Device Instance

The Device Instance is a 22-bit value (0–4,194,302) and must be unique throughout the entire BACnet internetwork. Its default value is set to 2749.

6.1.4.2 Device Object

Device Name is the BACnet Device Object Name which BACnet clients/supervisors will see when the BASpi-Edge is discovered and/or trended into a database.

6.1.4.3 UDP Port

The BACnet UDP port is set to 47808 as a decimal value, equivalent to BAC0 in hexadecimal by default. This UDP port number is used by BACnet clients when doing a discovery and communication on the BACnet network. This port number can be changed but must be the same in both the client and server BACnet devices for successful communication.

6.1.4.4 Broadcast Management Device (BBMD)

BACnet Broadcast Management Device (BBMD) feature requires a BACnet device with BBMD capability such as a BACnet router or other to be installed and configured on the network – [BASrouter](#) or [BASrouterLX](#) can be used to set up BBMD across different IP subnets.

BBMD Address is the address of the BBMD device on the network. Enter the address of the BBMD with which the BASpi-Edge will perform Foreign Device Registration (FDR) — if the BBMD is not in the same subnet as the BASpi-Edge.

BBMD Reg Time is the BBMD registration time. Specify the seconds between successive FDR registrations. Default is 100.

6.1.4.5 Time Transmission Interval

Time Trans (min) is the BACnet client TimeSync service time transmission interval setting. This can be used to synchronize the time on all BACnet devices on the network. Below the interval setting is the checkmarks for time transmission over BACnet/IP (BIP checkmark) or BACnet MS/TP (MS/TP checkmark). The time transmission relies on manually configured or NTP server (requires Internet connection) obtained time, UM-18050000-AA2

configured from the Set Time web page. There is no time retention in BASpi-Edge. If using the BASpi-Edge to synchronize time, a reliable NTP time server is strongly recommended to ensure the correct time is updated in the case of power loss.

6.1.4.6 Interface

The BASpi-Edge can operate on both Ethernet and Wi-Fi network adapters concurrently except for the BACnet/IP client/server which will only operate on the selected adapter. Select Wired for Ethernet or Wireless for Wi-Fi operation from the Interface dropdown selection – this is the network adapter the BACnet/IP client/server will operate on.

6.1.5 BACnet Tab - Client Configuration

BACnet Client configuration parameters allow you to tune the poll delay and poll retry delay (in ms) for BACnet communication between the BASpi-Edge client and BACnet server devices on the network. BACnet Client checkmark on Admin page must be checked/enabled for BACnet Client to work.

6.1.5.1 Poll Delay

The default BACnet client Poll Delay is set to 1000 ms which is a very appropriate setting for delay between data point polls for most applications. The shortest (minimum) poll delay allowed is 25 ms which should only be used in high performance or critical applications with concern for network loading. Depending on your application and limitations of your network, this parameter should be set to a reasonable value. Lower values provide higher performance, higher values introduce less stress on the network.

6.1.5.2 Retry Delay

If the BACnet client in the BASpi-Edge fails to read or write a BACnet point value for whatever reason (such as high network traffic or interrupted connection), it will retry every 1000 ms by default. This retry period can be changed to a minimum of 25 ms in the Retry Delay field. Depending on your application and limitations of your network, this parameter should be set to a reasonable value. Lower values provide higher performance, higher values introduce less stress on the network.

Admin	Wired	Wi-Fi	BACnet	MSTP	Close	Submit
-------	-------	-------	---------------	------	-------	--------

BACnet Configuration

Device Name	BASpi-Edge 6/4/2
Device Instance	21399
UDP Port	47808
BBMD IP Address	0.0.0.0
BBMD Reg Time	100
Time Trans (min)	0
	BIP <input type="checkbox"/> MS/TP <input type="checkbox"/>
Interface	WIRED ▼

BACnet Client

Poll Delay (ms)	1000
Retry Delay (ms)	1000
<input type="button" value="Configure BACnet Servers"/>	

NOTE: Caution must be used when setting the Retry Delay value because if this parameter is set to an extreme value such as 25 ms and a point is continuously not available causing the BACnet client to fail reading/writing the point, the BACnet client will retry to read/write this point at the specified Retry Delay rate which could potentially flood the network with retry messages sent at a high frequency.

6.1.6 BACnet Tab - Configure BACnet Servers

To set up a connection between the BASpi-Edge client and a BACnet server device(s), first you need to integrate the BASpi-Edge into your network by configuring its IP (optional MS/TP) and BACnet device settings in accordance with your existing IP and BACnet network settings. Then, the BACnet Server device(s) parameters can be configured from the Configure BACnet Servers page under the BACnet tab in System Configuration web page.

Admin	Wired	Wi-Fi	BACnet	MSTP	Close	Submit
-------	-------	-------	---------------	------	-------	--------

BACnet Configuration

Device Name	BASpi-Edge 6/4/2
Device Instance	21399
UDP Port	47808
BBMD IP Address	0.0.0.0
BBMD Reg Time	100
Time Trans (min)	0
	BIP <input type="checkbox"/> MS/TP <input type="checkbox"/>
Interface	WIRED

BACnet Client

Poll Delay (ms)	1000
Retry Delay (ms)	1000

Configure BACnet Servers

BACnet/IP client capability allows the BASpi-Edge to read and/or write points served up by devices on the BACnet internetwork. Most BACnet devices are BACnet servers which do not initiate requests to other devices other than an initial "I-Am" request when first joining the network. BACnet client devices do initiate requests and expect BACnet servers to respond to requests and data is exchanged. BACnet servers serve up their points to BACnet clients. Writable BACnet server device points can be written to by BACnet clients. The

BASpi-Edge supports BACnet objects of types: AI, BI, AO, BO, AV, and BV. The BASpi-Edge is capable of directly reading from and writing to BACnet/IP devices on the network connected to its Ethernet port or Wi-Fi radio (if Interface is configured for Wi-Fi) by use of NetV (Network Variable) Sedona components. In addition, with a BACnet router in place (such as [BASrouter](#) or [BASrouterLX](#)), the BASpi-Edge is capable of reading from and/or writing to BACnet MS/TP devices which are being routed to BACnet/ IP. Optionally, BACnet MS/TP devices which are directly connected to the BASpi-Edge using an optional EIA-485 to USB dongle (sold separately) can also be read/written.

Points obtained over the BACnet network can be used in the BASpi-Edge Sedona wire sheet control logic, become scaled, calculated, and/or converted to different data types, written to other BACnet devices, served up to BACnet supervisory controllers and operator workstations by using Virtual Components, as well as be monitored, displayed, or pushed to the Azure IoT Central cloud, exposed for configuration on the BASpi-Edge web page by the use of Web Components or Graphical Dashboard by use of Virtual Components.

Reading points over BACnet networks can be very useful in several applications such as zone temperature averaging, reading an outside air temperature from a BACnet networked sensor device, reading zone temperatures, humidity, CO₂ PPM, and other comfort parameters from a BACnet networked wall setter/thermostat comfort device, or exchanging control values/points with another BACnet controller or supervisory controller/workstation. In applications which do not require a complete BMS/head end, the BASpi-Edge can be used to read and write points among BACnet devices. In remote access applications, by employing Remote Access VPN IP routers (such as [EIPR-V](#), [EIGR-V](#), or [EICR](#)), the BASpi-Edge client can obtain and write BACnet points from devices on a remote BACnet network. Once you have configured the BASpi-Edge BACnet system settings, you are ready to set up the BACnet server devices which the BASpi-Edge will communicate with. To access this configuration, click on the Configure BACnet Servers button under BACnet tab in the System Configuration web page. This will allow you to set up BACnet server devices to poll from or write to with the BASpi-Edge.



6.1.6.1 BACnet Discovery Tool for IP Devices

The BACnet Discovery Tool can be very helpful when setting up BACnet Server Devices. All BACnet server configuration parameters such as Server Name, Device Instance, Local IP, etc. can be obtained by using the free [BACnet Discovery Tool - BDT](#).

BDT can be used to assist you in BACnet Server device configuration if the server device(s) is already online and available on the BACnet network. The tool is simple and easy to use. It discovers BACnet devices on the network available at the specified UDP port number (usually 47808). BDT will list the discovered BACnet server device's Device Instance number, Device Name, IP address, or MAC address (if the device is routed from BACnet MS/TP to BACnet/IP). If you know the BACnet server device parameters, or they are not yet online and discoverable on the BACnet network, you can enter their configuration parameters without the use of a BACnet discovery tool.

The BACnet discovery Tool can also be used to commission BACnet devices and/or verify proper BACnet network operation by discovering devices and points and reading and/or writing points. More of the BACnet Discovery Tool (BDT) features are outlined in the BDT Instruction Sheet provided with the tool download.

BACnet discovery tool example for BACnet/IP devices:

The BACnet Servers page allows you to configure a BACnet sever device the BASpi-Edge will poll from or write to by clicking the Add Server button. If the server device is BACnet/IP networked, and it is not routed (it is present on the same IP network), you do not need to check Routed or MS/TP checkboxes.

Enter a desired Server Name. The name can be anything which helps you identify the device, or it can be the actual Device Object Name of the BACnet server device as seen by other BACnet clients or in BACnet discovery tools.

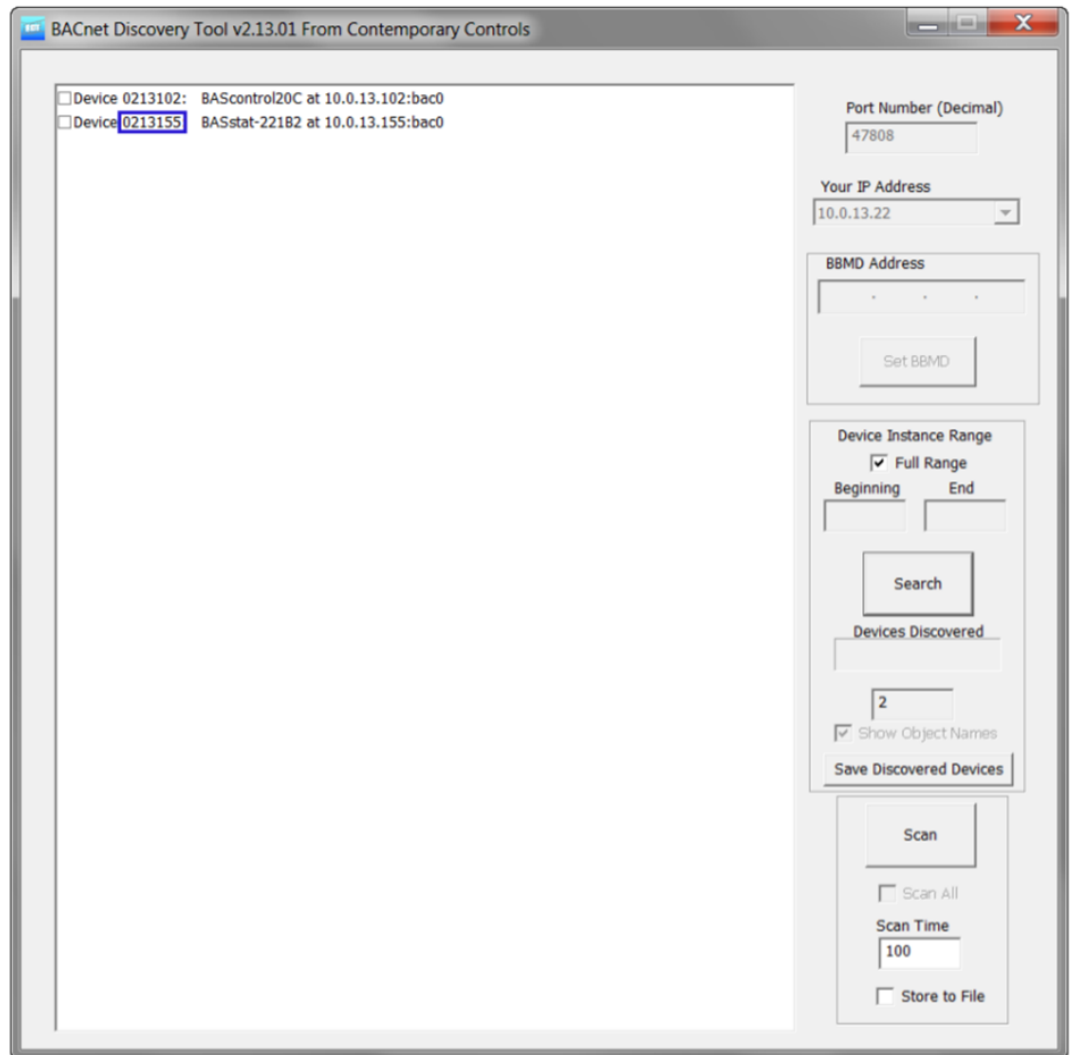

Enter the unique Device Instance number of the BACnet server device. This can be seen in the BACnet discovery tool (outlined in blue in the BACnet Discovery Tool example above), or it can be obtained from the BACnet server device's settings web page or hardware configuration if available. The Device Instance number will also be entered in the NetV (Network Variable) component(s) in the Sedona wire sheet for points applicable to this BACnet server device.

Local IP is the IP address of the BACnet server device. This can also be seen in the BACnet discovery tool or it can be obtained from the device's settings web page or network administrator.

BACnet Servers

Servers

Wire Sheet Components

Routed MS/TP

Server Name

Device Instance

Local IP

Submit

Cancel

Close

BACnet Servers

Servers

Wire Sheet Components

Routed MS/TP

Server Name

Device Instance

Local IP

Submit

Cancel

Close

Click the Submit button once finished with configuring the BACnet server device. Once the Submit button is clicked, the server device configuration will be saved, and it will become listed in the Servers dropdown at the top.

BACnet Servers

Servers Wire Sheet Components

Server BASstat-221C-BW2 ▼

Routed MS/TP

Server Name BASstat-221C-BW2

Device Instance 213155

Local IP 10.0.13.155

Revert Submit

Delete Server Add Server

Close

Repeat the process for adding more server devices. There is no hard-coded limit of how many devices can be set up. However, it is recommended that no more than 10 devices are set up as BACnet servers to the BASpi-Edge.

BACnet server device communication requires a restart of the BASpi-Edge in order to become active. Click the Close button to close BACnet Servers page and System Configuration page and restart the controller by clicking Restart Controller from the main web page. After this process the NetV components which use the BACnet Server Configuration can be utilized on the Sedona wire sheet.

6.1.6.2 Configuring Routed BACnet MS/TP Server Devices

Configuring a Routed or directly connected BACnet MS/TP device is done in a similar fashion. A BACnet router (such as [BASrouter](#) or [BASrouterLX](#)) is needed to route the BACnet MS/TP device to BACnet/IP so the BASpi-Edge can communicate with it on the BACnet/IP network (Routed and MS/TP checkmarks must be checked). Use BDT to perform a discovery in order to obtain all configuration parameters or simply enter them in if they are known.

Enter the Device Name, Device Instance, Router Address for BACnet MS/TP devices routed to BACnet/IP, Network (net) for BACnet MS/TP devices routed to BACnet/IP, and MAC address as shown in the BDT example below.

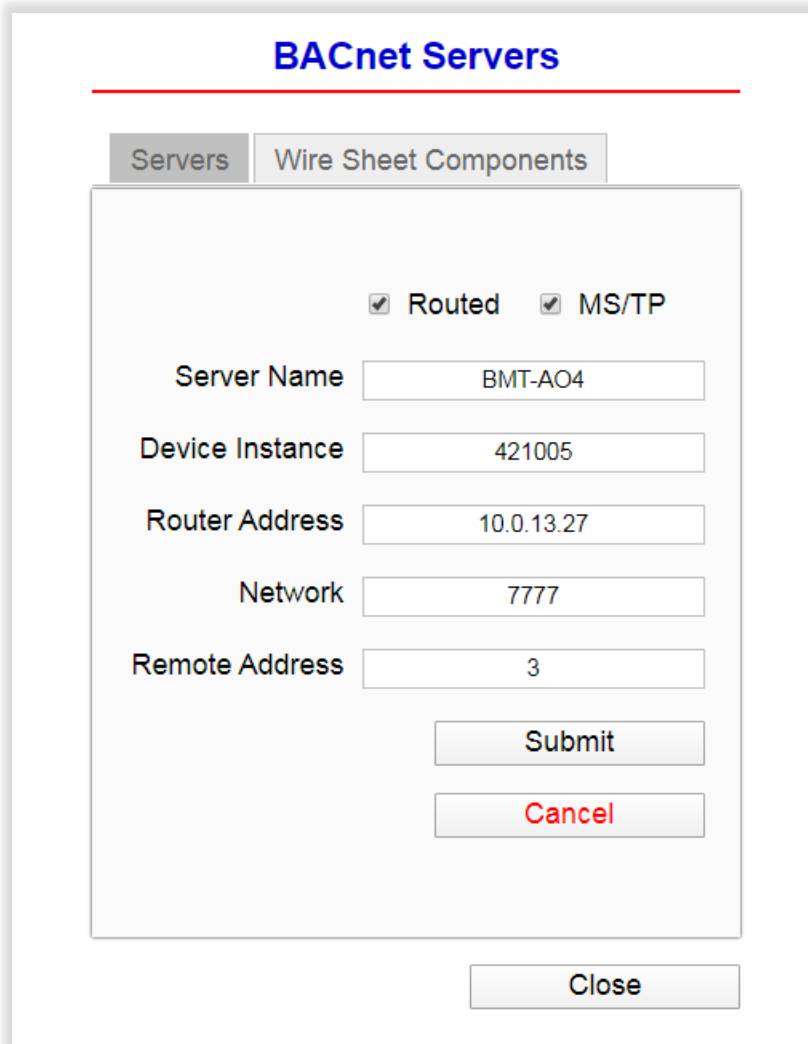

The image shows a software dialog box titled "BACnet Servers". At the top, there are two tabs: "Servers" (which is selected) and "Wire Sheet Components". Below the tabs, there are two checked checkboxes: "Routed" and "MS/TP". The main area of the dialog contains five text input fields, each with a label to its left and a value inside the field:

- Server Name: BMT-AO4
- Device Instance: 421005
- Router Address: 10.0.13.27
- Network: 7777
- Remote Address: 3

At the bottom of the dialog, there are three buttons: "Submit", "Cancel" (in red text), and "Close".

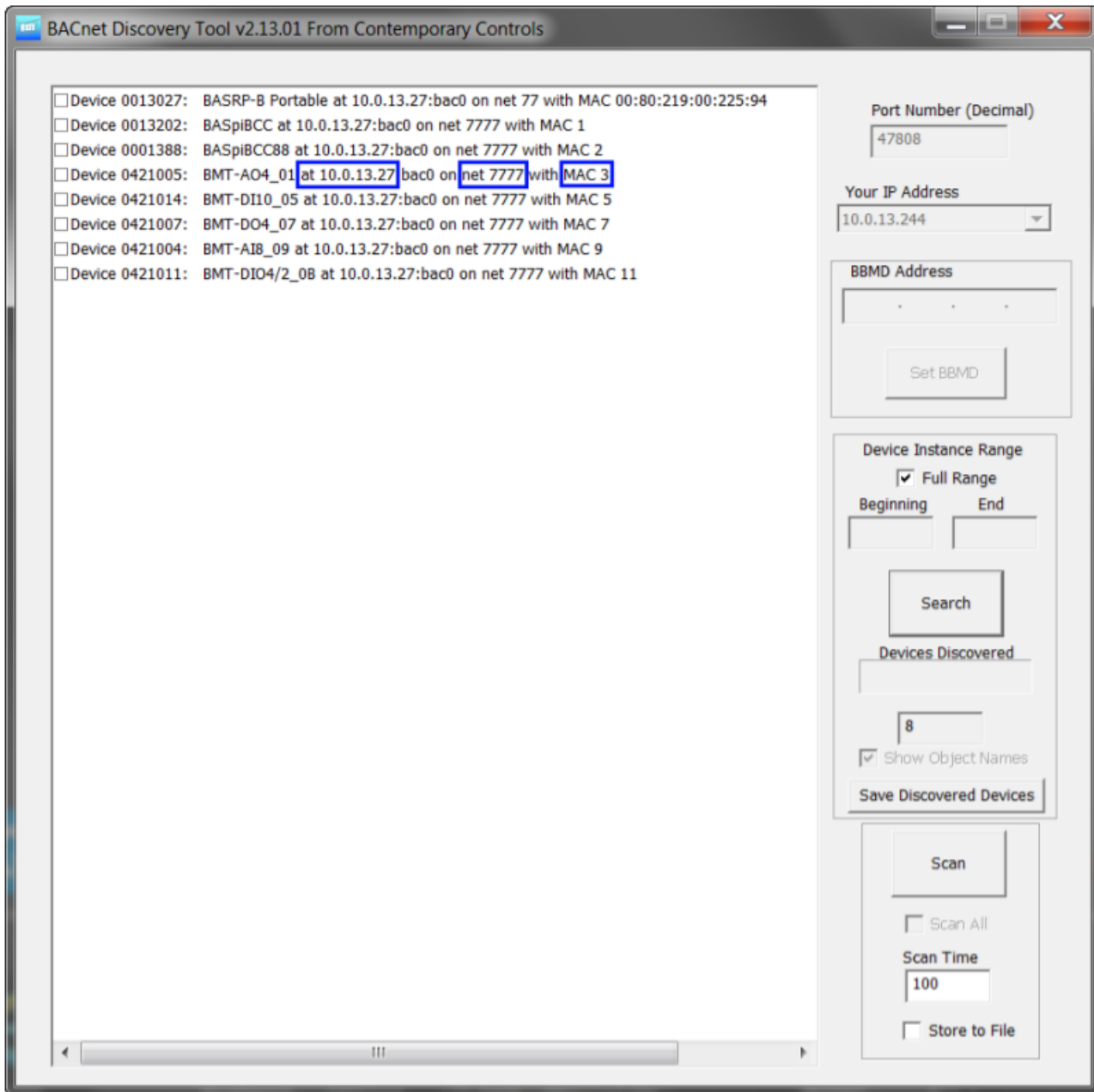

Click the Submit button once finished with configuring the BACnet MS/TP server device(s). Once the Submit button is clicked, the server device configuration will be saved, and it will become listed in the Servers dropdown at the top.

BACnet Servers

Servers Wire Sheet Components

Server

Routed MS/TP

Server Name

Device Instance

Router Address

Network

Remote Address

6.1.6.3 Configuring Routed BACnet non-MS/TP Server Devices

BACnet servers may have more complex MAC addresses when being routed, for example the Modbus devices routed through our BASgatewayLX product will have 6-byte MAC addresses. Also, our EnOcean gateway will also use 6-byte MAC addresses for EnOcean devices which appear on the BACnet network. For these types of servers you will need to select the routed checkbox (uncheck the MS/TP checkbox), enter the IP address of the gateway in the local IP box, enter the network number and enter the bytes of the unit’s MAC address in the Remote Address box with “.” between each byte, for example, “29.216.19.04.00.00.” Devices with 4-byte addresses can also be supported in a similar manner.

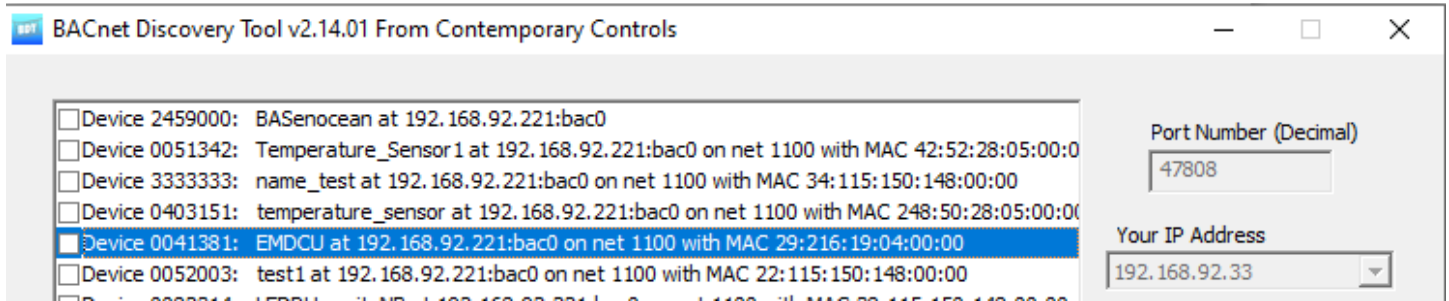

BACnet Servers

Servers Wire Sheet Components

Routed MS/TP

Server Name

Device Instance

Router Address

Network

Remote Address

6.1.6.4 Configuring USB Dongle BACnet MS/TP Devices

UM-18050000-AA2

By using and configuring the optional EIA-485 to USB dongle (sold separately), the BASpi-Edge can be discovered as an MS/TP server device. In addition, it can directly read and/or write BACnet MS/TP device points on the connected bus. To activate BACnet MS/TP client functionality, BACnet MS/TP check mark and BACnet Client check mark must be checked/enabled. In addition, the EIA-485 to USB dongle must be plugged in and configured in the MS/TP configuration tab – covered in 6.1.7.1 BACnet MS/TP Setup for EIA-485 to USB Dongle section.

To configure a BACnet MS/TP server device(s), only the MS/TP checkmark needs to be checked/enabled when communicating through the EIA-485 to USB dongle. Enter the Device Name, Device Instance, and MAC address. Click Submit to save configuration.

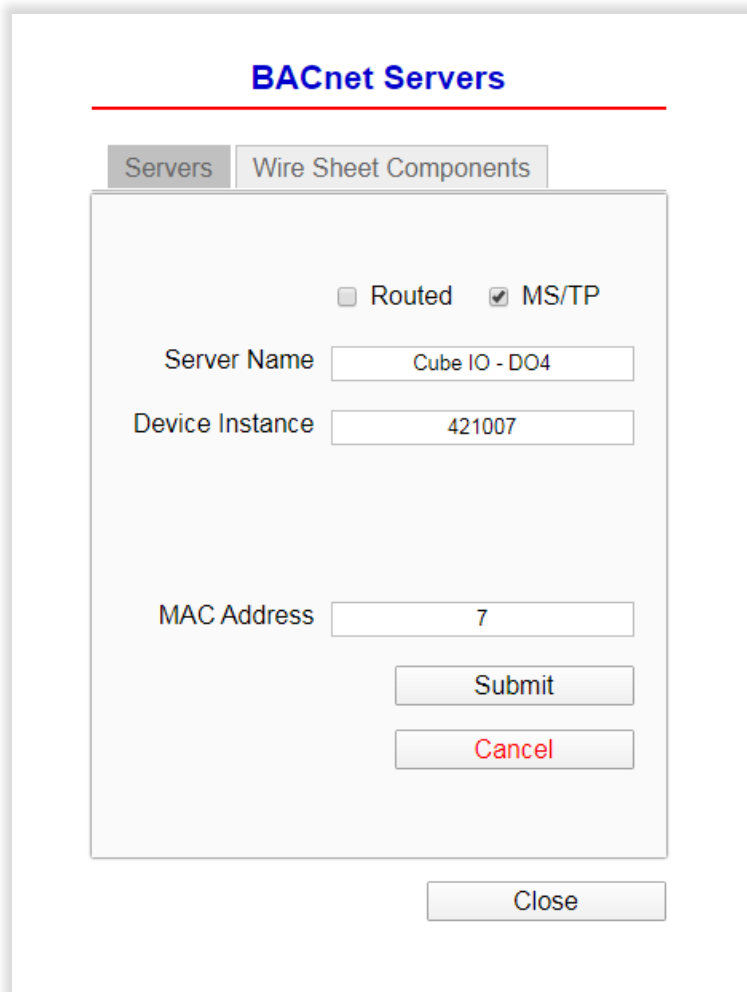

The image shows a software interface titled "BACnet Servers" with a red underline. Below the title are two tabs: "Servers" (selected) and "Wire Sheet Components". The "Servers" tab contains a form with the following elements:

- Two radio buttons: "Routed" (unchecked) and "MS/TP" (checked).
- A "Server Name" text box containing "Cube IO - DO4".
- A "Device Instance" text box containing "421007".
- A "MAC Address" text box containing "7".
- Two buttons: "Submit" and "Cancel" (in red text).
- A "Close" button located below the main form area.

Repeat the process for adding more server devices. There is no limit on devices imposed, however it is not recommended to add more than 10 devices.

BACnet client - server device communication requires a restart of the BASpi-Edge in order to become active.

After the reboot, the BASpi-Edge is ready to poll points from or write points to the BACnet server devices configured. BACnet server device points are configured from the Sedona wire sheet in the BASpi-Edge using

NetV (Network Variable) components. To open the Sedona wire sheet of the BASpi-Edge, you can use our free Sedona Application Editor (SAE). The Sedona Application editor is available for free as part of the [BAScontrol Toolset](#).

6.1.7 The MSTP Tab

6.1.7.1 BACnet MS/TP Setup for EIA-485 to USB Dongle

In order to make the BASpi-Edge BACnet MS/TP connected, an EIA-485 to USB dongle is required (dongle is sold separately). The dongle allows the BASpi-Edge to become a BACnet client/server node on the BACnet MS/TP network. To begin configuration, insert the EIA-485 to USB dongle to one of the available USB ports on the BASpi-Edge. Click the Restart Controller button on the main web page - the dongle will be picked up by the

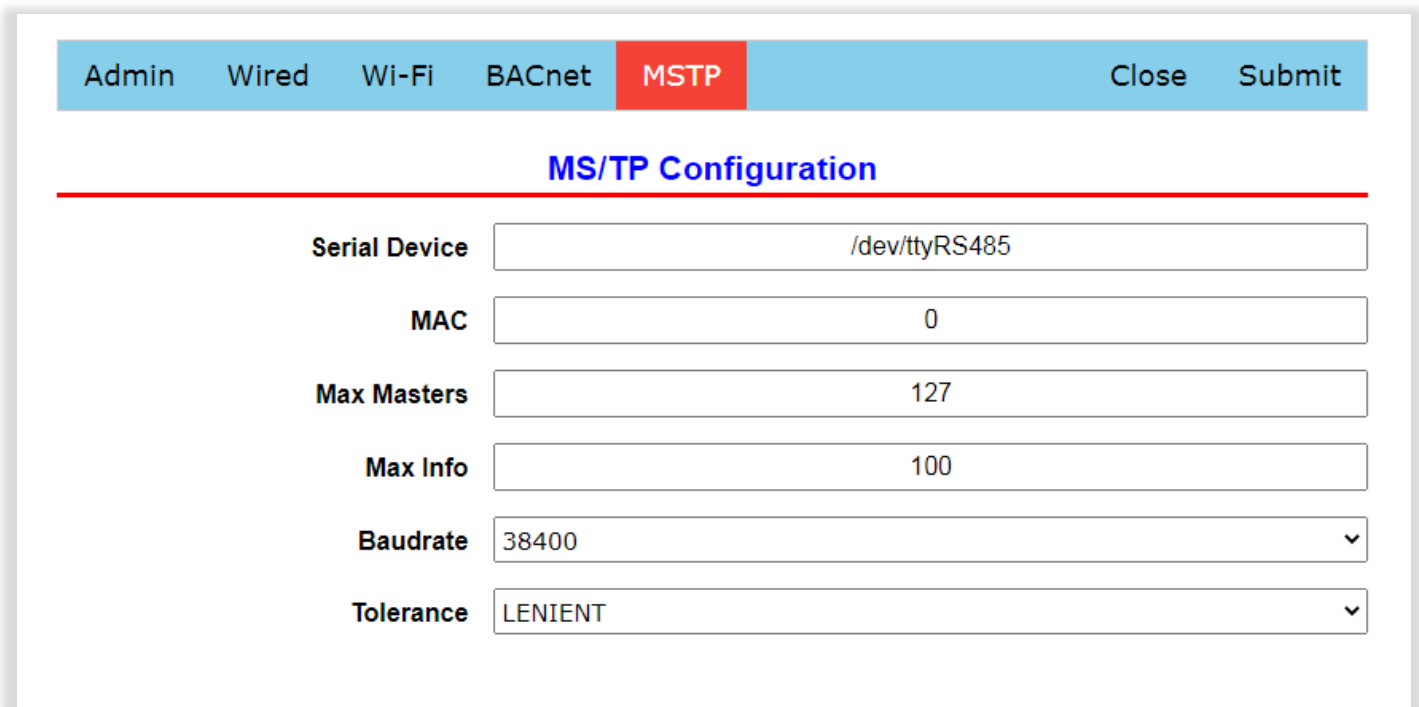

MS/TP Configuration	
Serial Device	<input type="text" value="/dev/ttyRS485"/>
MAC	<input type="text" value="0"/>
Max Masters	<input type="text" value="127"/>
Max Info	<input type="text" value="100"/>
Baudrate	<input type="text" value="38400"/>
Tolerance	<input type="text" value="LENIENT"/>

system automatically, its default Serial Device address of `/dev/ttyRS485` is populated and shown in the Serial Device field in the MS/TP configuration web page. The Serial Device address does not need to be modified even if other USB cables such as touchscreen data connection are plugged in. The dongle LED lights will show some activity. If the dongle is not automatically detected by the system, or the dongle LEDs are not flickering, click the Restart Controller button or right click and select Restart OS on the main web page.

6.1.7.2 MAC Address

BASpi-Edge MAC address must be configured to be unique for the serial network bus the BASpi-Edge is connected to. The MAC must be a unique 8-bit (0–127) value in decimal. Lower MAC address numbers are preferred. It is further recommended that all other BACnet devices attached to the same MS/TP network be assigned consecutive MAC addresses beginning with 1 without allowing any gaps in addressing to optimize token passing and data exchange.

6.1.7.3 Max Master Nodes

Only master nodes participate in the MS/TP token-passing process. BASpi-Edge does not support BACnet MS/TP slave device communication. The highest master MAC address (in decimal) in the MS/TP network is 127 and you should use 127 if you are unsure of other MS/TP device addresses. Each MS/TP device should use this same value. For a value in this field to be proper, it must equal or exceed the highest MAC address for any master present on the network. Optimum performance occurs when this value: equals the highest MAC address of any master, and all masters use sequential MAC addresses starting with 1. Since many BACnet devices do not allow this parameter to be changed, Max Master value of 127 is universal and will ensure a working network.

6.1.7.4 Max Info

Max Info is the maximum number of messages that can be exchanged onto the MS/TP network by the BASpi-Edge per token pass. Its range is 1–100, and the typical value is 100. The default value provides good performance, especially if the BASpi-Edge BACnet client is reading/writing values directly from the BACnet MS/TP network.

6.1.7.5 Baud Rate

The baud rate of the MS/TP network can be 9600, 19200, 38400, 57600, 76800, or 115200 bps. All MS/TP devices on the same MS/TP network must use the same baud rate for successful communication.

6.1.7.6 Tolerance

This setting determines the degree to which interoperability with devices is successful. The Lenient option is less efficient for traffic flow but optimizes interoperability and therefore is chosen as default. When using Lenient the BASpi-Edge will wait longer for devices to respond to a poll for master request. A slight improvement in performance will be realized by selecting the Strict setting given that the network is optimized, and other devices are able to respond fast enough.

6.1.7.7 EIA-485 to USB Dongle for BACnet MS/TP Connection

The optional EIA-485 to USB dongle (sold separately) allows the BASpi-Edge to be directly connected to a BACnet MS/TP network as a client/server node. BASpi-Edge will serve its BACnet points over this connection when the BACnet MS/TP checkmark is checked/enabled on the Admin page, as well as read/write other master devices on the bus once they are configured as BACnet Servers in the BASpi-Edge BACnet Servers configuration page and the BACnet Client checkmark on the Admin tab is checked/enabled.

The USB dongle or the BASpi-Edge do not provide network bias or termination. Network bias and termination must be provided by another device on the network such as a [BASrouter](#) or [BASrouterLX](#) or [BAS-485-TER](#) device. For successful BACnet MS/TP operation, the EIA-485 standard requires that a Signal Common (SC) ground reference connected to all devices on the bus is used.

For a 3-wire BACnet MS/TP network connection, the USB dongle provides a GND pin in addition to positive and negative pins which must be connected between all devices on the network. This allows devices to communicate even if they are not sharing a common power source.

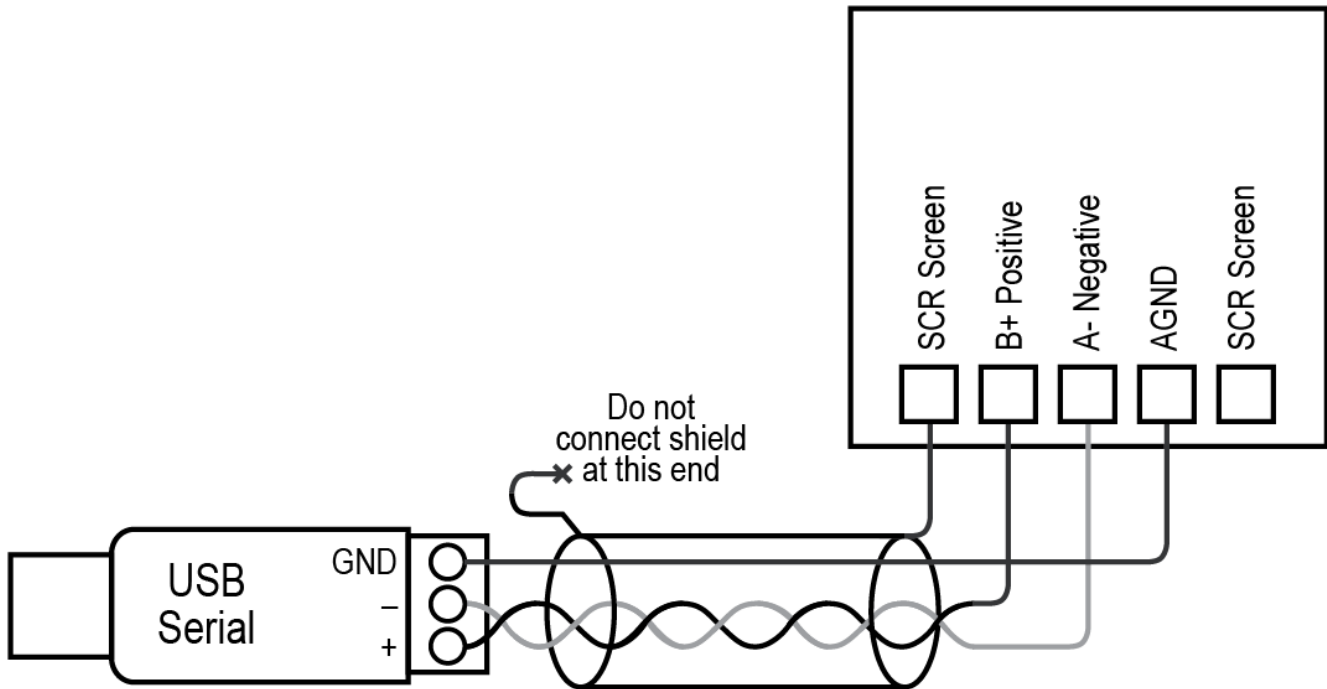

For isolated MS/TP ports such as this VFD, a 3-wire interface is required to connect to the signal common of the isolated port. It is recommended to use a 1.5-pair cable such as Connect Air W241.5P-5400ALN. Tie the shield only at the drive side of the connection as shown in this drawing. Tape back the shield at the BASpi-Edge end. Observe polarity of the twisted-pair cable connections.

For 2-wire network connection, connect B+ and A- while observing polarity. The GND pin is not used in 2-wire applications. The devices must share a common power source or have the Earth ground connection on their power supplies connected to Earth.

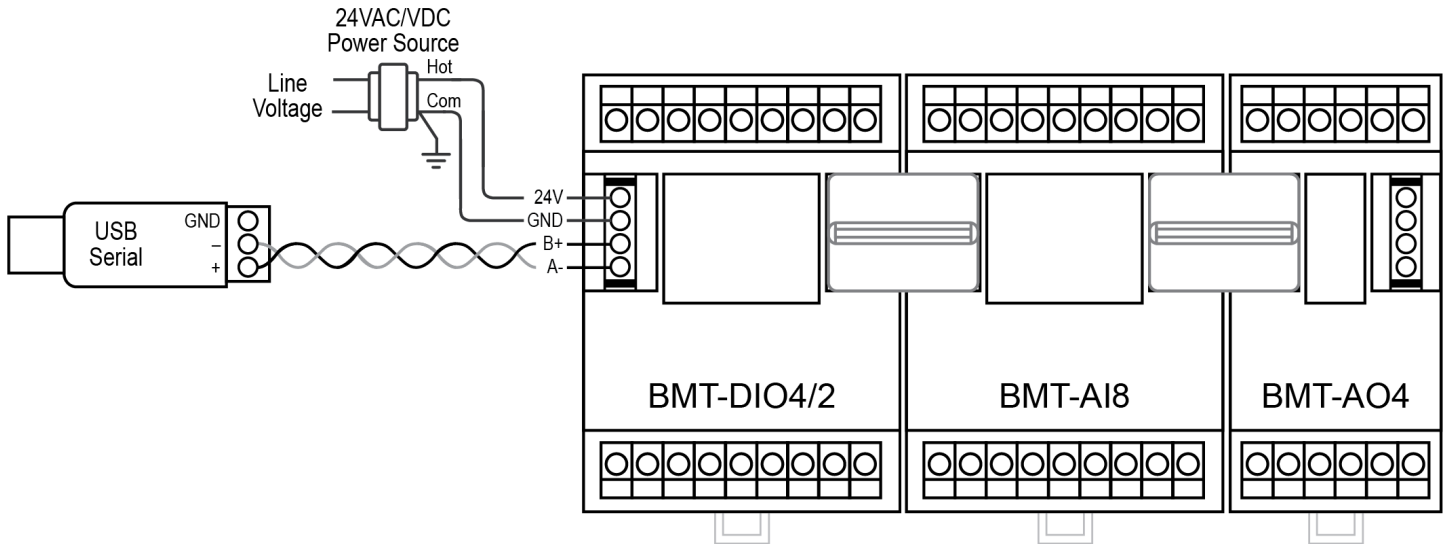

Once satisfied with all System Configuration including Admin, Wired, Wireless, BACnet, BACnet Servers, and MS/TP, click Submit, then Close. Click the Restart Controller button on the Main Web Page to restart services changes have been made to, or right click any of the access buttons and choose Restart OS to restart the entire BASpi-Edge system for configuration changes to be applied.

6.1.8 Configuring BACnet Server Device Points

The points of the previously configured BACnet server devices are configured from the BASpi-Edge Sedona wire sheet. In order to configure server device points, open a Sedona connection to the BASpi-Edge. The example below shows using Contemporary Controls' free Sedona Application Editor (SAE).

Click Open Connection button at the SAE toolbar and type the BASpi-Edge's IP address in the Host field. Then, enter the default credentials of *admin* for Username and *admin* for Password and click the OK button to connect.



The BASpi-Edge wire sheet will open, and you are ready to write wire sheet logic as well as configure BACnet server points. To create a NetV component, simply drag-and-drop it on the wire sheet. NetV components are available in the CControls_BASCPiE_NETV kit for BASpi-Edge 6/6 or the CControls_BASCAO2E_NETV kit for BASpi-Edge 6/6.

Once placed on the wire sheet, the NetV component needs to be configured to communicate with one of the BACnet server devices previously configured on the BASpi-Edge BACnet Server Configuration as described in Section 6.1.6.

To configure a NetV component, drag and drop the one you want to use on the wire sheet. The NetV component must have the Device Instance configured, which must be the same as previously configured on the Configure BACnet Servers web page as well as the correct Object Instance. The Object Instance can be seen in BDT - see screenshot below with object instances outlined in blue.

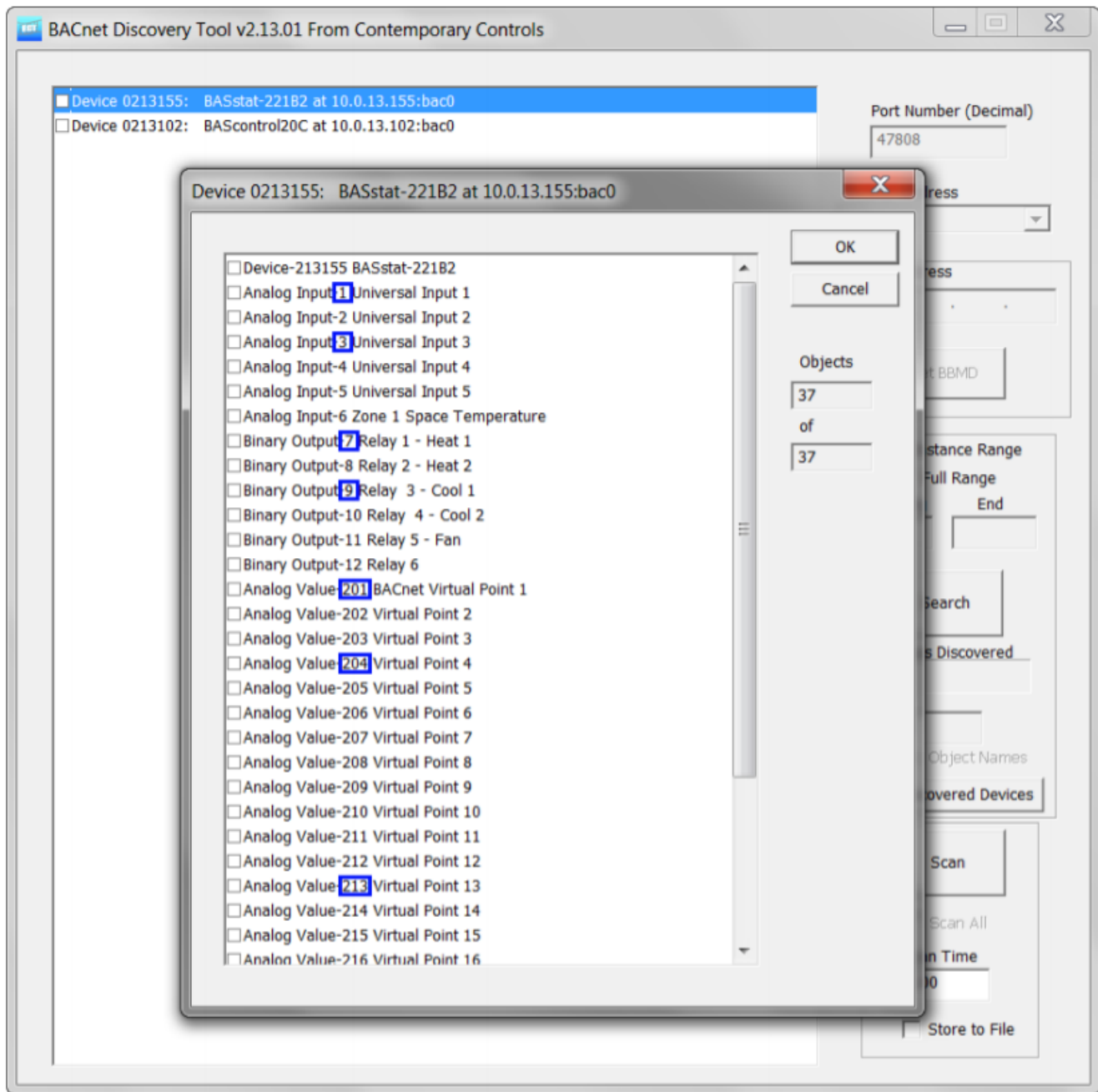

The OutUse slots must be configured as Input or Output before the NetV can get to Online state. Once you have configured the NetV objects and they have come to Online state, you can observe the NetV components state for each configured BACnet server device on the Configure BACnet Servers web page in the BASpi-Edge by clicking on the Wiresheet Components Tab - see screenshots below. You can choose the NetV component of interest from the dropdown menu and refresh its data by clicking the Refresh Component button. The Reload Components button allows you to reload the component in the case of loss of communication with the BACnet server.

NetV	
CControls_BASCC_NETV::NetV	
DevInstance	13178
ObjInstance	1
ObjType	AnalogInput
Priority	10
DefOutF	0.0
DefOutB	false
DefOutI	0
ValF	83.01
ValB	true
ValI	83
Relinquish	false
Enabled	false
Status	Online

BACnet Servers

Servers
Wire Sheet Components

Component

Device Instance

Object Instance

Object Type

Action

Status

Value

Several NetV components are available in the CControls_BASCPiE_NETV kit for BASpi-Edge 6/6 or the CControls_BASCAO2E_NETV kit for BASpi-Edge 6/6.

6.1.8.1 NetV Component

NetV	
CControls BASCAO2E NETV::NetV	
DevInstance	21306
ObjInstance	1
ObjType	AnalogInput
Priority	10
DefOutF	0.0
DefOutB	false
DefOutI	0
ValF	76.47
ValB	true
Vall	76
Relinquish	false
Enabled	false
Status	Online

NetV is the most universal component in the client kits which can be configured to read or write a single point (object) on the target BACnet server device. This is a read or write component.

DevInstance slot must have the correct target device instance configured which must be the same as the device instance of the target device of interest configured in the Configure BACnet Servers page in System Configuration under the BACnet tab.

ObjInstance slot must be configured with the correct target device object instance to be read/written.

ObjType can be of any of the following BACnet object types and configured as Analog Input (AI), Analog Output (AO), Analog Value (AV), Binary Input (BI), Binary Output (BO), or Binary Value (BV), Accumulator (ACC), Multistate Input (MSI), Multistate Output (MSO), or Multistate Value (MSV). ACC, MSI, MSO and MSV are only available on the BAScontrol-v4 series. If the point configured in the NetV is a writable point such as AO, AV, BO, or BV, ACC, MSO, or MSV, the Enabled slot must be set to true, if the object is read only such as AI or BI – set the Enabled slot to false.

Priority slot lets you configure the BACnet write priority for writable objects with range of 1 through 16 and default value of 10.

DefOutF, DefOutB, and DefOutI are slots used for setting a safe default value for an output or input in Float, Bool, and Integer data types. If the NetV object is offline (server device not reachable), you need to be able to put the system Sedona logic in a safe state using these slots.

ValF, ValB, and Vall read the target object present value property when Enabled slot is set to false and command (write) the target object present value property when Enabled slot is set to true.

Enabled slot is used to set the point (object) as writable when set to true or read only when set to false.

Relinquish slot is used to release the writable target object by removing the write and setting the specified write priority of the configured target object to NULL when triggered to true. The write to the target object at the specified priority is applied again when the Relinquish slot is toggled back to false.

Status slot indicates the Online, Offline, or Not Configured states for the target object.

6.1.8.2 NETVAI4 Component

NETVAI4	
CControls BASCAO2E NETV::NETVAI4	
DevInstance	21306
Inp1Instance	1
Inp1Use	Input
Inp2Instance	2
Inp2Use	Input
Inp3Instance	3
Inp3Use	Input
Inp4Instance	4
Inp4Use	Input
Inp1	76.47
Inp2	76.15
Inp3	76.39
Inp4	76.43
Status	Online

NETVAI4 component allows the reads of up to 4 BACnet objects on the remote BACnet server device of type Analog Input (AI). This is a read only component.

DevInstance slot must have the correct target device instance configured which must be the same as the device instance of the target device of interest configured in the Configure BACnet Servers page in System Configuration under the BACnet tab.

Inp1Instance, Inp2Instance, Inp3Instance, and Inp4Instance slots must be configured with the correct target device object instances to be read.

Inp1Use, Inp2Use, Inp3Use, and Inp4Use are slots which allow you to set the use for each of the 4 objects. Since the NETVAI4 is a read only component, the two options are Input and Not Used.

Inp1, Inp2, Inp3, and Inp4 slots display the target object present value property read from the target BACnet server device.

Status slot indicates the Online, Offline, or Not Configured states for the target object.

6.1.8.3 NETVAO4 Component

NETVAO4	
CControls BASCAO2E NETV::NETVAO4	
DevInstance	21306
Out1Instance	13
Out1Use	Input
Out1Priority	10
Out2Instance	14
Out2Use	Input
Out2Priority	10
Out3Instance	15
Out3Use	Input
Out3Priority	10
Out4Instance	16
Out4Use	Input
Out4Priority	10
Out1	8.61
Relinquish1	false
Out2	4.30
Relinquish2	false
Out3	8.61
Relinquish3	false
Out4	4.30
Relinquish4	false
Status	Online

NETVAO4 component allows the reads or writes of up to 4 BACnet objects of type Analog Output (AO). This is a read/write component.

DevInstance slot must have the correct target device instance configured which must be the same as the device instance of the target device of interest configured in the Configure BACnet Servers page in System Configuration under the BACnet tab.

Out1Instance, Out2Instance, Out3Instance, and Out4Instance slots must be configured with the correct target device object instances to be read.

If the OutUse slot for a given object is configured for Input, the component will read the target device AO object present value property. If the OutUse slot is configured for Output, the component will write to the target device AO object present value property. If the OutUse slot is configured for NotUsed, the slot is not in use.

Out1Priority, Out2Priority, Out3Priority, and Out4Priority slots let you configure the BACnet write priority for writable target objects with range 1 through 16 and default value of 10.

Out1, Out2, Out3, and Out4 slots read the target object present value property when OutUse slot is set to Input and command (write) to the target object present value property when OutUse slot is set to Output.

Relinquish1, Relinquish2, Relinquish3, and Relinquish4 slots are used to release the writable target objects by removing the write and setting the specified write priority of the configured target objects to NULL when triggered to true. The write to the target object at the specified priority is applied again when the Relinquish slots are toggled back to false.

Status slot indicates the Online, Offline, or Not Configured states for the target object.

6.1.8.4 NETVAV4 Component

NETVAV4	
CControls_BASCC_NETV::NETVAV4	
DevInstance	1234
Out1Instance	244
Out1Use	Input
Out1Priority	10
Out2Instance	243
Out2Use	Input
Out2Priority	10
Out3Instance	242
Out3Use	Output
Out3Priority	10
Out4Instance	241
Out4Use	Output
Out4Priority	10
Out1	17.1
Relinquish1	false
Out2	68.15
Relinquish2	false
Out3	98.0
Relinquish3	false
Out4	19.0
Relinquish4	false
Status	Online

NETVAV4 component allows reading or writing of up to 4 BACnet objects of type Analog Value (AV). When the OutUse slot is configured for Input, the component will read the target device AV object present value property. When the OutUse slot is configured for Output, the component will write to the target device AV object present value property. When the OutUse slot is configured for NotUsed, the slot is not in use. Slots configured as NotUsed will not consume RAM memory.

OutPriority slots let you configure the BACnet write priority for writable target objects with range 1 through 16 and default value of 10.

Out1, Out2, Out3, and Out4 slots read the target object present value property when OutUse slot is set to Input and command (write) to the target object present value property when OutUse slot is set to Output.

Relinquish slot is used to release the writable target object by removing the write and setting the specified write priority of the configured target object to NULL when triggered to true. The write to the target object at the specified priority is applied again when the Relinquish slot is toggled back to false.

Status slot indicates the Online or Offline state for the target object.

6.1.8.5 NETVBI4 Component

NETVBI4	
CControls_BASCAO2E_NETV::NETVBI4	
DevInstance	21306
Inp1Instance	9
Inp1Use	Input
Inp2Instance	10
Inp2Use	Input
Inp3Instance	11
Inp3Use	Input
Inp4Instance	12
Inp4Use	Input
Inp1	false
Inp2	false
Inp3	false
Inp4	false
Status	Online

NETVBI4 component allows the reads of up to 4 BACnet objects of type Binary Input (BI). This is a read only component.

DevInstance slot must have the correct target device instance configured which must be the same as the device instance of the target device of interest configured in the Configure BACnet Servers page in System Configuration under the BACnet tab.

Inp1Instance, Inp2Instance, Inp3Instance, and Inp4Instance slots must be configured with the correct target object instances to be read.

Inp1Use, Inp2Use, Inp3Use, and Inp4Use are slots which allow you to set the use for each of the 4 objects. Since the NETVBI4 is a read only component, the two options are Input and Not Used.

Inp1, Inp2, Inp3, and Inp4 slots display the target object present value property read from the target BACnet server device.

Status slot indicates the Online, Offline, or Not Configured states for the target object.

6.1.8.6 NETVBO4 Component

NETVBO4	
CControls_BASCAO2E_NETV::NETVBO4	
DevInstance	21306
Out1Instance	17
Out1Use	Input
Out1Priority	10
Out2Instance	18
Out2Use	Input
Out2Priority	10
Out3Instance	19
Out3Use	Input
Out3Priority	10
Out4Instance	20
Out4Use	Input
Out4Priority	10
Out1	false
Relinquish1	false
Out2	true
Relinquish2	false
Out3	false
Relinquish3	false
Out4	true
Relinquish4	false
Status	Online

NETVBO4 component allows the reads or writes of up to 4 BACnet objects of type Binary Output (BO). This is a read/write component.

DevInstance slot must have the correct target device instance configured which must be the same as the device instance of the target device of interest configured in the Configure BACnet Servers page in System Configuration under the BACnet tab.

Out1Instance, Out2Instance, Out3Instance, and Out4Instance slots must be configured with the correct target device object instances to be read.

If the OutUse slot for a given object is configured for Input, the component will read the target device BO object present value property. If the OutUse slot is configured for Output, the component will write to the target device BO object present value property. If the OutUse slot is configured for NotUsed, the slot is not in use.

Out1Priority, Out2Priority, Out3Priority, and Out4Priority slots let you configure the BACnet write priority for writable target objects with range 1 through 16 and default value of 10.

Out1, Out2, Out3, and Out4 slots read the target object present value property when OutUse slot is set to Input and command (write) to the target object present value property when OutUse slot is set to Output.

Relinquish1, Relinquish2, Relinquish3, and Relinquish4 slots are used to release the writable target objects by removing the write and setting the specified write priority of the configured target objects to NULL when triggered to true. The write to the target object at the specified priority is applied again when the Relinquish slots are toggled back to false.

Status slot indicates the Online, Offline, or Not Configured states for the target object.

NOTE: Any BACnet object (Object Instance) from the same BACnet device (Device Instance) can only be used in the BASpi-Edge Sedona wire sheet once. If a second instance of the same BACnet Object Instance with the same Device Instance is created/configured, one of the two instances will be Offline.

6.1.8.7 NETVBV4 Component

NETVBV4	
CControls_BASCC_NETV::NETVBV4	
DevInstance	1234
Out1Instance	247
Out1Use	Input
Out1Priority	10
Out2Instance	248
Out2Use	Output
Out2Priority	10
Out3Instance	246
Out3Use	Input
Out3Priority	10
Out4Instance	245
Out4Use	Output
Out4Priority	10
Out1	true
Relinquish1	false
Out2	false
Relinquish2	false
Out3	false
Relinquish3	false
Out4	true
Relinquish4	false
Status	Online

NETVBV4 component allows reading or writing of up to 4 BACnet objects of type Binary Value (BV). When the OutUse slot is configured for Input, the component will read the target device BV object present value property. When the OutUse slot is configured for Output, the component will write to the target device BV object present value property. When the OutUse slot is configured for NotUsed, the slot is not in use. Slots configured as NotUsed will not consume RAM memory.

OutPriority slots let you configure the BACnet write priority for writable objects with range 1 through 16 and default value of 10. Out1, Out2, Out3, and Out4 slots read the target object present value property when OutUse slot is set to Input and command (write) to the target object present value property when OutUse slot is set to Output.

Relinquish slot is used to release the writable target object by removing the write and setting the specified write priority of the configured target object to NULL when triggered to true. The write to the target object at the specified priority is applied again when the Relinquish slot is toggled back to false. The Status slot indicates the Online or Offline state for the target object.

6.1.8.8 Examples

In this first example below, we have configured a NETVAI4 to read 4 Analog Inputs from a BACnet server on the network.

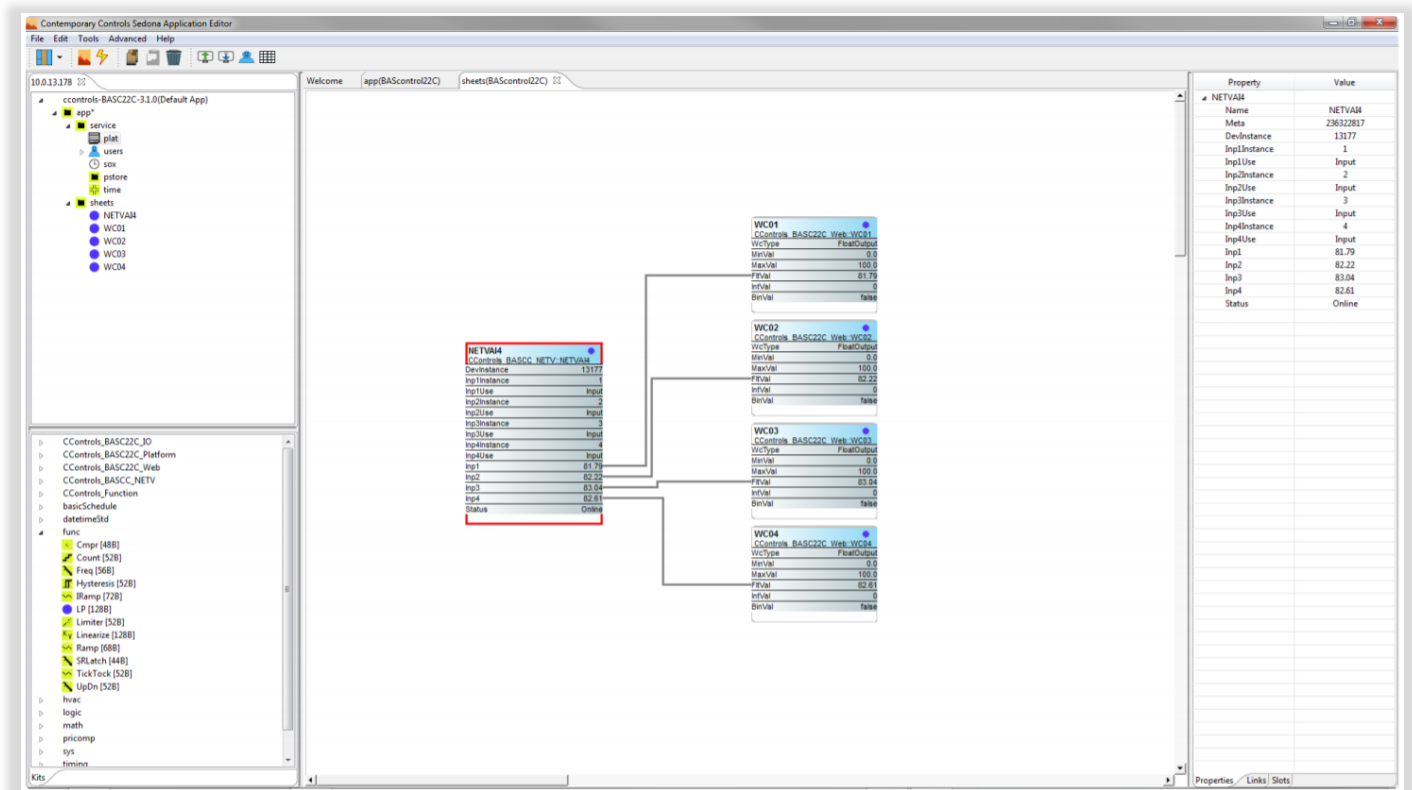

NETVAI4 Property Pane configuration:

Property	Value
NETVAI4	
Name	NETVAI4
Meta	236322817
DevInstance	13177
Inp1Instance	1
Inp1Use	Input
Inp2Instance	2
Inp2Use	Input
Inp3Instance	3
Inp3Use	Input
Inp4Instance	4
Inp4Use	Input
Inp1	81.62
Inp2	82.67
Inp3	83.71
Inp4	83.36
Status	Online

In this next example below, we have configured a NETVAO4 to write to 4 Analog Outputs from a BACnet server on the network.

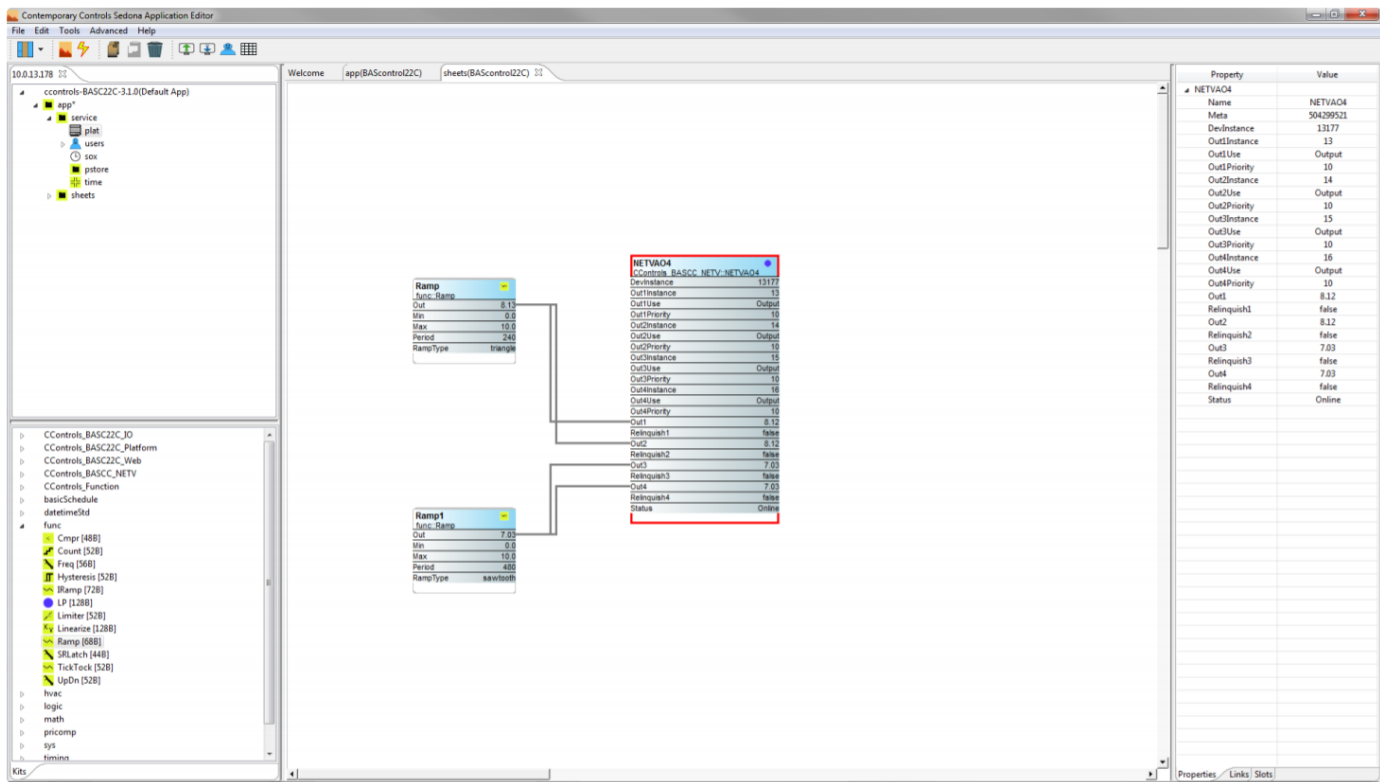

NETVAI4 Property Pane configuration:

Property	Value
NETVAO4	
Name	NETVAO4
Meta	504299521
DevInstance	13177
Out1Instance	13
Out1Use	Output
Out1Priority	10
Out2Instance	14
Out2Use	Output
Out2Priority	10
Out3Instance	15
Out3Use	Output
Out3Priority	10
Out4Instance	16
Out4Use	Output
Out4Priority	10
Out1	9.57
Relinquish1	false
Out2	9.57
Relinquish2	false
Out3	7.39
Relinquish3	false
Out4	7.39
Relinquish4	false
Status	Online

6.2 System Status Pages

The System Status page provides information useful for tech support and troubleshooting the BASpi-Edge. The installed firmware revision number is displayed in the Revision field. The Ethernet and Wi-Fi MAC addresses are displayed in the Wired MAC and Wi-Fi MAC fields respectively. The available RAM memory in bytes is displayed in the Memory field. The System Message Log will print out and log system events and statements about several different aspects of the BASpi-Edge firmware such as cloud, email, weather, or main platform engine selectable from the dropdown at the bottom. Logs can be copied and pasted and sent to tech support for analysis. The logs can be refreshed using the Refresh button. This page is mostly useful for technical support purposes.

System Status

Revision 1.0.32.0	Wired MAC b8:27:eb:57:40:30	Wifi MAC b8:27:eb:02:15:65	Memory 507715584
-----------------------------	---------------------------------------	--------------------------------------	----------------------------

System Message Log

```
2020-07-09 17:17:11.360 INFO [883] Setting system time to: Mon Jul 13 14:50:12 2020
2020-07-13 14:50:13.039 INFO [806] Setting DB LEDs to normal operation
2020-07-13 14:50:13.140 INFO [806] Entering main loop
2020-07-13 14:51:12.072 INFO [883] NTP success; setting system time
2020-07-13 14:51:12.072 INFO [883] Setting system time to: Mon Jul 13 14:51:12 2020
2020-07-14 00:00:12.319 INFO [883] NTP success; setting system time
2020-07-14 00:00:12.321 INFO [883] Setting system time to: Tue Jul 14 00:00:12 2020
2020-07-14 07:17:09.694 INFO [790] GPIO initialized
2020-07-14 07:17:10.775 INFO [790]
2020-07-14 07:17:10.776 INFO [790] *****BASemulator : 1.0.32.0 : Jul 1 2020 : 23:10:19*****
2020-07-14 07:17:10.776 INFO [790] Operating in platform mode
2020-07-14 07:17:10.776 INFO [790] BASCAO2E firmware revision 1.0.32.0
2020-07-14 07:17:10.913 INFO [883] bacnet-ip : 1.0.32.0 : Jun 22 2020 : 18:43:18
2020-07-14 07:17:10.914 ERROR [883] Unable to open serial port: /dev/ttyUSB0
2020-07-14 07:17:10.914 ERROR [883] initMstp() failed
2020-07-14 07:17:10.914 INFO [884] bipListen() thread running
2020-07-14 07:17:11.214 INFO [790] Web server running on port 80
2020-07-14 07:17:11.214 INFO [890] Sedona VM BAScontrol 2.0.1
2020-07-14 07:17:11.215 INFO [890] buildDate: Jun 25 2020 12:06:44
```

BAScontrol ▾ Refresh Log Close

6.2.1 MS/TP Status

The MS/TP Statistics web page reports the traffic of the BACnet MS/TP driver using the EIA-485 to USB dongle connection and it can be very useful to confirm proper BACnet MS/TP bus and server node operation as well as troubleshoot it in case of BACnet MS/TP communication issues or failure. Several parameters are UM-18050000-AA2

reported such as incoming and outgoing packets, state machine state, poll station, next station, transmit and receive PFM (poll for master) counts as well as transmit and receive token counts. After the packet counts, the instantaneous state of some BASpi-Edge MS/TP state machine values are displayed. These are documented in the MS/TP portion of the BACnet standard — with the following parameters being noteworthy:

RFSM is the current Receive Frame State Machine state.

MNSM is the current Master Node State Machine state.

Next Station is the MS/TP MAC address of the device to which the BASpi-Edge will next pass the token. This value may change if devices leave or enter the network — and when the BASpi-Edge searches for devices on the network, as per the BACnet MS/TP standard.

NOTE; If this value does not change from the BASpi-Edge's own MS/TP MAC address while connected to the MS/TP bus, the BASpi-Edge is not finding any other MS/TP devices on the bus.

The Status Screen refreshes automatically — so you can watch the MS/TP state change and gain insight into the condition of the MS/TP network (as seen by the BASpi-Edge). For example, if MNSM always reports SoleMaster or PollForMaster, for a prolonged period after repeated refreshes, then the router cannot communicate with any MS/TP devices.

TX PFM Count is the number of Polls for Master messages transmitted.

RX PFM Count is the number of Poll for Master messages received.

TX Token Count is the number of tokens transmitted.

RX Token Count is the number of tokens received.

Invalid Long Frames is the number of frames received which have a length longer than allowed.

Clear Silence Timer is the number of times the silence resets because its value is too large.

MS/TP Statistics

MS/TP Incoming Packets

0

Next Station

0

TX PFM Count

0

Silence Timer

0

MS/TP Outgoing Packets

0

Poll Station

0

RX PFM Count

0

Clear Silence Timer

N/A

RFSM State

00 Idle

Invalid Long Frames

0

TX Token Count

0

Event Count

0

MNSM State

00 Initialize

Available Memory

N/A

RX Token Count

0

Flag

Not Set

Close

6.2.2 Set Time

Set Time page provides all time and date related settings. Time and date can be set manually or automatically with the help of an NTP server if access to the Internet is possible over Ethernet or Wi-Fi. Daylight Savings Time can be enabled and configured accordingly. If accessing an NTP server (such as the default pool.ntp.org) using domain names, make sure proper DNS servers are specified in the System Configuration screen.

System Time

Year

Month

Day

Hour

Minute

NTP Configuration

NTP Enabled

NTP Server

Time Zone

Refresh (Days)

NTP Success

Sunrise/Sunset

Latitude

Longitude

Sunrise **5:16 AM**

Sunset **8:26 PM**

DST Configuration

DST Enabled

	DST ON	DST OFF
Month	<input type="text" value="March"/>	<input type="text" value="November"/>
Day of Month	<input type="text" value="2nd SUN"/>	<input type="text" value="1st SUN"/>
Hour	<input type="text" value="2 AM"/>	<input type="text" value="2 AM"/>

To manually set the time, enter in the desired parameters for Year, Month, Day, Hour, and Minute and click Manual Time Set button. To observe time changes in real time, click Refresh ON.

The Sunrise Sedona component can be used to determine sunrise and sunset times based on geolocation. Enter in your location's Latitude and Longitude to provide input data for the component. The calculation will be performed automatically, and Sunrise and Sunset times will be displayed on the Set Time page accordingly. The Sunrise component will then give a true/false binary output for IsDaytime with values of true for daytime and false for night-time, as well as minutes to sunrise and minutes to sunset in MinToSunrise and MinToSunset slots respectively. MinToSunrise is accurate when IsDayTime is false (night-time) and MinToSunset is accurate when IsDayTime is true (daytime). These values can be used in the wire sheet control logic.

Sunrise	🕒
CControls BASCAO2E IO::Sunrise	
IsDaytime	true
MinToSunrise	1440
MinToSunset	84

To enable or disable NTP server obtained time, check or uncheck the NTP Enabled checkmark. Proper time is important when creating schedules or using the BACnet Time Sync service of the BASpi-Edge to synchronize time on BACnet server devices on the network.

NTP is a protocol which synchronizes clocks to UTC (Coordinated Universal Time). Default NTP server domain name is shown (pool.ntp.org) and can be altered if needed. Internet connection is required for NTP server communication. When NTP is enabled, the NTP server will be queried and the BASpi-Edge time will be synchronized at start-up and at midnight during each refresh period. Set the Time Zone to match that of your location. NTP Refresh (in Days) is the refresh interval with default value of 1 day. NTP Success status is shown in green. NTP Failure status is shown in red.

DST (Daylight Saving Time, aka Summertime) configuration is provided, because NTP cannot adjust for them. The drop-down menus allow you to set the date and the time after midnight for enabling and disabling DST. DST Enabled checkmark must be checked/enabled to enable DST. Click the Submit button and then the Close button when finished with all time and date configuration.

6.2.3 Virtual Points

Virtual Points have their own web page. Virtual Points can be configured to be analog (AV) or binary (BV) and allow communication to and from a BACnet client to the BASpi-Edge Sedona wire sheet. Virtual Points are usually setpoints, calculated data, occupancy commands, filter flags, or other status points that do not directly impact the physical input/output points that exist on the controller. A GREEN tag means that the virtual point has been placed on the wire sheet. Virtual Points support full BACnet Priority Array whether configured for Binary Value or Analog value.

Virtual Points

<p>VT01 OccupyViaNetwork <input style="width: 80px;" type="text" value="0"/> <input type="checkbox"/></p> <p>VT04 OccHeatingSetpoint <input style="width: 80px;" type="text" value="70.000"/> <input type="checkbox"/></p> <p>VT07 Virtual Point 7 <input style="width: 80px;" type="text" value="0.000"/> <input type="checkbox"/></p> <p>VT10 OutAirTempNetwork <input style="width: 80px;" type="text" value="65.000"/> <input type="checkbox"/></p> <p>VT13 Virtual Point 13 <input style="width: 80px;" type="text" value="0.000"/> <input type="checkbox"/></p> <p>VT16 EffectHeatingSetpoint <input style="width: 80px;" type="text" value="55.000"/> <input type="checkbox"/></p> <p>VT19 CoolingDemand <input style="width: 80px;" type="text" value="100.000"/> <input type="checkbox"/></p> <p>VT22 Virtual Point 22 <input style="width: 80px;" type="text" value="0.000"/> <input type="checkbox"/></p>	<p>VT02 OccupyOvrDuration <input style="width: 80px;" type="text" value="120.000"/> <input type="checkbox"/></p> <p>VT05 UnocCoolingSetpoint <input style="width: 80px;" type="text" value="0.000"/> <input type="checkbox"/></p> <p>VT08 EmergencyOffViaNetwork <input style="width: 80px;" type="text" value="0"/> <input type="checkbox"/></p> <p>VT11 OutAirHumidNetwork <input style="width: 80px;" type="text" value="50.000"/> <input type="checkbox"/></p> <p>VT14 ModeEnumStatus <input style="width: 80px;" type="text" value="5.000"/> <input type="checkbox"/></p> <p>VT17 EffectCoolingSetpoint <input style="width: 80px;" type="text" value="0.000"/> <input type="checkbox"/></p> <p>VT20 Virtual Point 20 <input style="width: 80px;" type="text" value="0.000"/> <input type="checkbox"/></p> <p>VT23 TroubleAlert <input style="width: 80px;" type="text" value="0"/> <input type="checkbox"/></p>	<p>VT03 OccCoolingSetpoint <input style="width: 80px;" type="text" value="75.000"/> <input type="checkbox"/></p> <p>VT06 UnocHeatingSetpoint <input style="width: 80px;" type="text" value="55.000"/> <input type="checkbox"/></p> <p>VT09 ZoneTempNetwork <input style="width: 80px;" type="text" value="70.000"/> <input type="checkbox"/></p> <p>VT12 HeatCoolModeCmd <input style="width: 80px;" type="text" value="0"/> <input type="checkbox"/></p> <p>VT15 Virtual Point 15 <input style="width: 80px;" type="text" value="0.000"/> <input type="checkbox"/></p> <p>VT18 HeatingDemand <input style="width: 80px;" type="text" value="0.000"/> <input type="checkbox"/></p> <p>VT21 Virtual Point 21 <input style="width: 80px;" type="text" value="0.000"/> <input type="checkbox"/></p> <p>VT24 HeartbeatFromBMS <input style="width: 80px;" type="text" value="1"/> <input type="checkbox"/></p>
--	---	--

NOTES:

1. A GREEN label means that the virtual point has been placed on the wire sheet. The label hover text indicates if the point is configured as "Read from Wire Sheet" or "Write to Wire Sheet"

There are 48 virtual point components (VT01–VT48) in the CControls_BASCPiE_IO and CControls_BASCAO2E_IO kits. Virtual Point components are used to link Sedona wire sheet readable/writeable data to a BACnet client. BACnet clients can discover, read and command these Virtual Points which can be linked as an input to the wire sheet or an output from the wire sheet (Read from wire sheet/Write to wire sheet).

Virtual Points could be used for setpoint, or reset data intended for the wire sheet or calculations, or status information generated by the wire sheet. When Virtual Points are set for outputs, they can be given a Default Value in their BAS Channel Configuration. Default Value is a value used by the output, immediately after boot-up of the controller when Sedona logic or BACnet client have yet to command the output point. As soon as Sedona logic or a BACnet client write to the point, Default Value is no longer used by the output. When BACnet priorities 1 through 16 are all nullified, the output point will use Default Value set in the channel configuration web page of the output point. This value is also reported to BACnet as Relinquish Default, but cannot be written to by BACnet clients, it can only be set from the channel’s web page in the BASpi-Edge.

Although BACnet allows for the reading of the BASpi-Edge physical input and output points — and under certain conditions the writing of real output points — virtual points have no reading or writing restrictions. Virtual points are treated by BACnet as either a binary variable (BV) or analog variable (AV) while real points appear as binary inputs (BI), analog inputs (AI), binary outputs (BO) or analog outputs (AO).

The BASpi-Edge logic engine reads the state of its inputs (AI and BI) and outputs (AO and BO), executes logic, and then sets outputs (AO and BO) accordingly. In a similar manner, a BACnet client can read the BASpi-Edge physical inputs and write to the BASpi-Edge physical outputs.

AVs and BVs are a bit different in that they can be configured to be either an input to the BACnet client or an output from the BACnet client. If a BACnet client is to write to the Sedona wire sheet such as a command, a VT can be assigned to input this data to the wire sheet so using the Sedona tool we would configure the VT’s Wiresheet slot to Input to Wire Sheet. This will result in a channel type (Chn Type) of float input or binary input, depending upon the AV or BV selection on the VT’s channel configuration. If a BACnet client is to read data from the Sedona wire sheet such as status, assign a VT to output this data from the wire sheet. Using the Sedona tool, configure the VT’s Wiresheet slot to Output from Wire Sheet. This will result in a channel type (Chn Type) of float output or binary output depending upon the AV or BV selection on the VT’s channel configuration.

VT40	
CControls_BASCAO2E_IO::VT40	
Initialized	true
ChnType	FloatInput
Reset	false
FloatV	0.00
BinaryV	true
WireSheet	InputTo

VT48	
CControls_BASCAO2E_IO::VT48	
Initialized	true
ChnType	FloatOutput
Reset	false
FloatV	0.00
BinaryV	true
WireSheet	OutputFrom

Virtual Points are multifunctional and used for Weather service data, utilized in Dashboards and pushed to the Cloud if configured. Weather service data parameters are assigned to individual Virtual Points. A Virtual Point is used for each Weather service parameter, such as Temperature. If another Weather service parameter is needed such as Pressure, a second Virtual Point is assigned that parameter and so on. Since Virtual Points are served over BACnet, this means that weather data could be served or written to other BACnet devices on the network. Virtual Points can also be pushed to the Cloud and utilized in Dashboards. Any Sedona wire sheet value can be pushed to the cloud or written to from the Cloud by using a Virtual Point. A value obtained over the local network by using a NetV (Network Variable) component can also be pushed to the Cloud or used in a Dashboard if tied to a Virtual

Point. It is advisable to use Virtual Points in Dashboards especially in HMI (Human-Machine-Interface) applications where outputs can be engaged by users, because this gives the integrator the opportunity to create additional safety logic between the Virtual Point displayed on the HMI and the physical output being engaged/disengaged.

6.2.3.1 Virtual points Web page

Access the Virtual Points web page and click on the title link of a Virtual Point of interest to gain access to its configuration page. Select either Analog Value or Binary Value from the Object Type parameter under BACnet Object Configuration. Notice that the radio button Read from Wire Sheet or Write to Wire Sheet reflects the point of view of the BACnet client. This can only be changed by the Sedona tool for each Virtual Point component once placed on the wire sheet.

The screenshot displays two configuration sections for a Virtual Point (VT01). The top section, titled "BAS Channel Configuration", includes a "Channel Type" dropdown menu set to "Virtual" and a "Default Value" input field containing "0". The bottom section, titled "BACnet Object Configuration", includes an "Object Instance" field with "201", an "Object Name" field with "Virtual Point 1", an "Object Type" dropdown menu set to "Analog Value", and two radio buttons: "Read from wire sheet" (unselected) and "Write to wire sheet" (selected). The "Object Description" field also contains "Virtual Point 1", and the "Units" dropdown menu is set to "NO_UNITS". At the bottom, there is a "COV Increment" input field with "0", and two buttons labeled "Close" and "Submit".

Object Instance is the BACnet object instance which is not configurable – it is automatically assigned.

Object Name, Object Description, and Units can also be configured in the channel configuration page. These values are served over BACnet to clients and supervisors, Dashboards, and used in the Azure IoT Central cloud setup.

A Default Value can be set for each output channel. This is the normal output value the controller will use as a starting control value in the case of power loss before a BACnet client has written to the channel or Sedona logic had been triggered. This Default Value is also the Relinquish Default value outside of the BACnet priority array used when no other higher priority (1 – 16) writes are present. Relinquish Default value is used when all other priorities are at null value.

The BACnet COV Increment (Change of Value) can be set for each Virtual Point at the respective configuration page. COV Increment is the change of value increment used by BACnet clients/supervisors which support this service. COV only reports changes in value instead of continuously serving the point value. COV can be useful to mitigate traffic on the IP network or conserve point trend database space in BACnet supervisory devices. All 12 BASpi-Edge physical I/O channels and 48 Virtual Points support COV. You do not need to set up COV unless the BACnet client you are using supports this service.

Units dropdown allows you to specify the units for the channel value. To configure channel units, click on the Units dropdown and select a unit for the point.

BAS Channel Configuration

VT01

Channel Type

Default Value

BACnet Object Configuration

Object Instance

Object Name

Object Type **Read from wire sheet**
 Write to wire sheet

Object Description

Units

COV Increment

6.3 Web Components

The Web Components web page allows for the use and configuration of up to 48 Web Components. Web Components are not served over BACnet or used in graphical Dashboards or Cloud, but they provide a means to write or read data to and from the Sedona wire sheet directly from the BASpi-Edge web page. These components can be used for altering Sedona wire sheet control parameters (such as setpoints), monitoring of wire sheet logic states, or adjusting logic sequence for variation in control applications. Web components are ideal for simplified control logic configuration.

Configured for wire sheet input.

WC01	
CControls_BASCAO2E_Web::WC01	
Wc Type	Input
MinVal	0.0
MaxVal	100.0
FItVal	0.0
IntVal	0
BinVal	false

Configured for wire sheet binary output

WC24	
CControls_BASCAO2E_Web::WC24	
Wc Type	BinaryOutput
MinVal	0.0
MaxVal	1.0
FItVal	0.0
IntVal	0
BinVal	false

Configured for wire sheet float output

WC48	
CControls_BASCAO2E_Web::WC48	
Wc Type	FloatOutput
MinVal	0.0
MaxVal	85.0
FItVal	0.0
IntVal	0
BinVal	false

A web component configured as a wire sheet input can have its input range restricted to minimum and maximum values, eliminating the need to add limit detection within the wire sheet logic.

Web Components

	Description	Value	Wire Sheet	Min	Max
WC01	Default Web Component 1	0	Input	0	100
WC02	Default Web Component 2	0	Input	0	100
WC03	Default Web Component 3	0	Input	0	100
WC04	Default Web Component 4	0	Input	0	100
WC05	Default Web Component 5	0	Input	0	100
WC06	Default Web Component 6	0	Input	0	100
WC07	Default Web Component 7	0	Input	0	100
WC08	Default Web Component 8	0	Input	0	100

Refresh OFF NOTE: A GREEN label indicates that the component has been placed on the wire sheet Close Submit

To observe Web Component value changes in real time, click the Refresh OFF button to ON state.

6.4 Schedule

The BASpi-Edge supports multiple advanced schedules with configurable events (holidays/exceptions). Multiple independent schedules can be created. Advanced schedules are web page configurable and a bound corresponding Sedona schedule component for each schedule (CControls_BASCAO2E_Schedule kit and CControls_BASCPiE_Schedule kit, Sched component) is used to trigger Sedona wire sheet control logic. The name of the schedule created in the web page is also entered in the Sedona schedule component to bind them. Schedules depend on proper time setting in the BASpi-Edge which can be set manually or obtained over an Internet connection from an NTP time server. To configure schedules, click on the Schedule button on the BASpi-Edge main web page.

Schedule Name dropdown is used to select a given schedule when multiple schedules are present. Default Schedule is the only option in this dropdown by default. Once more schedules are created and stored, they will appear in this dropdown menu where they can be selected and viewed, edited, or deleted.

To edit a selected schedule's name, use the pencil icon button at the top.

To delete a selected schedule entirely, use the trash can icon button at the top.

To create a new schedule, use the plus icon button at the top.



6.4.1 Default Schedule

The Default Schedule tab for a selected Schedule Name shows the default (regular week) schedule – the schedule for weeks with no events (holidays/exceptions). The pencil icon button at the lower right corner can be used to edit the Default Schedule for the Schedule Name selected. Occupied/Unoccupied times are entered in military time (HH:MM) 24hr format.

Schedule Configuration

Schedule Name

▼Default Schedule



Current Schedule

Default Schedule

Events

	Occupied	<input type="checkbox"/>	Unoccupied	
Sunday	Vacant	<input checked="" type="checkbox"/>	Vacant	
Monday	8:00	<input type="checkbox"/>	17:00	<p>Times are entered as hour and minutes in the form 'HHMM' in 24 hour format.</p> <p>Examples: 8:30 AM is entered as 8:30 8:30 PM is entered as 20:30</p>
Tuesday	8:00	<input type="checkbox"/>	17:00	
Wednesday	8:00	<input type="checkbox"/>	17:00	
Thursday	8:00	<input type="checkbox"/>	17:00	
Friday	8:00	<input type="checkbox"/>	17:00	
Saturday	8:00	<input type="checkbox"/>	12:00	
	Vacant			

Close

6.4.2 Current Schedule

UM-18050000-AA2

The Current Schedule tab for a selected Schedule Name shows the current week's schedule with any events (holidays/exceptions) present that week which are listed under the Events column for each applicable day. To browse through current weekly schedules for the Schedule Name selected, use the Year and Week dropdowns or green arrows at the bottom of the page. Events (holidays/exceptions) that are set up for any given week will be shown under the Events column for each applicable day (New Year's Day in example below).

Schedule Configuration

Schedule Name

Default Schedule
▼

Current Schedule		Default Schedule			Events
		Occupied		Unoccupied	Event
Sunday	2020-12-27	Vacant	<input checked="" type="checkbox"/>	Vacant	
Monday	2020-12-28	8:00	<input type="checkbox"/>	17:00	
Tuesday	2020-12-29	8:00	<input type="checkbox"/>	17:00	
Wednesday	2020-12-30	8:00	<input type="checkbox"/>	17:00	
Thursday	2020-12-31	8:00	<input type="checkbox"/>	17:00	
Friday	2021-01-01	Vacant	<input checked="" type="checkbox"/>	Vacant	New Years Day
Saturday	2021-01-02	8:00	<input type="checkbox"/>	12:00	

Vacant

Year

2020
▼

◀

Week

53:Dec
▼

▶

Close



6.4.3 Events

The Events tab is where special events with custom Occupied and Unoccupied times, or Vacancy (unoccupied for entire day) can be created. Occupied/Unoccupied times are entered in military time (HH:MM) 24hr format.

Schedule Configuration

Schedule Name

Default Schedule▼



Current Schedule

Default Schedule

Events

Name

New Years Day▼

Occupied

Vacant

Month

January▼

Vacant

Unoccupied

Vacant



Day Of Month

1▼

Numbered
Day Of Month

Times are entered as hour and minutes in the form 'HHMM' in 24 hour format.

Examples:
8:30 AM is entered as 8:30
8:30 PM is entered as 20:30



Close

Some standard holidays (New Year's Day, Independence Day, Thanksgiving, Christmas Eve, Christmas Day) have been pre-entered for the Default Schedule Name.

Schedule Configuration

Schedule Name

Default Schedule



Current Schedule

Default Schedule

Events

Name

New Years Day

New Years Day

Independence Day

Thanksgiving

Christmas Eve

Christmas Day

January

1

Occupied

Vacant

Day Of Month

Numbered

Day Of Month

Times are entered as hour and minutes in the form 'HHMM' in 24 hour format.

Examples:

8:30 AM is entered as 8:30

8:30 PM is entered as 20:30



Close

To select a configured event, use the Name dropdown.

To edit a selected event, use the pencil icon button at the lower right corner.

To delete a selected event entirely, use the trash can icon button at the lower right corner.

6.4.3.1 New Event

To create a new event, use the plus icon button at the lower right corner. Enter a name for the event. Using the Numbered radio button option, choose a Month and Day of Month and Occupied/Unoccupied times or check off the Vacancy check box for vacancy (unoccupied for entire day).

Alternatively, a new event can also be entered as Day of Month instead of Numbered. Using the Day of Month radio button option, choose Month and Day of Month (such as 4th Thursday in November for Thanksgiving) and Occupied/Unoccupied times or check off the Vacancy check box for vacancy (unoccupied for entire day). This allows you to keep the event without having to change its exact date as it changes to a different date every year.

Occupied/Unoccupied times are entered in military time (HH:MM) 24hr format as shown in the Examples.

Schedule Configuration

Schedule Name

Edit Event

Name

New Years Day

Occupied

Vacant

Vacant



Unoccupied

Vacant

Times are entered as hour and minutes in the form 'HHMM' in 24 hour format.

Month

January

Day Of Month

1

Examples:

8:30 AM is entered as 8:30

8:30 PM is entered as 20:30

Numbered

Day Of Month

Cancel

Update

Close

Schedule Configuration

Schedule Name

Add New Event

Name

Thanksgiving

Occupied

Vacant

Vacant



Unoccupied

Vacant

Times are entered as hour and minutes in the form 'HHMM' in 24 hour format.

Month

November

Day Of Month

4th THU

Numbered

Day Of Month

Examples:

8:30 AM is entered as 8:30

8:30 PM is entered as

20:30

Cancel

Add

Close

To create an entirely new Schedule Name with its own Events and Default Schedule, use the plus icon button at the top. You will be asked to enter in a name for the new schedule. Then you can configure its Default Schedule and Events.

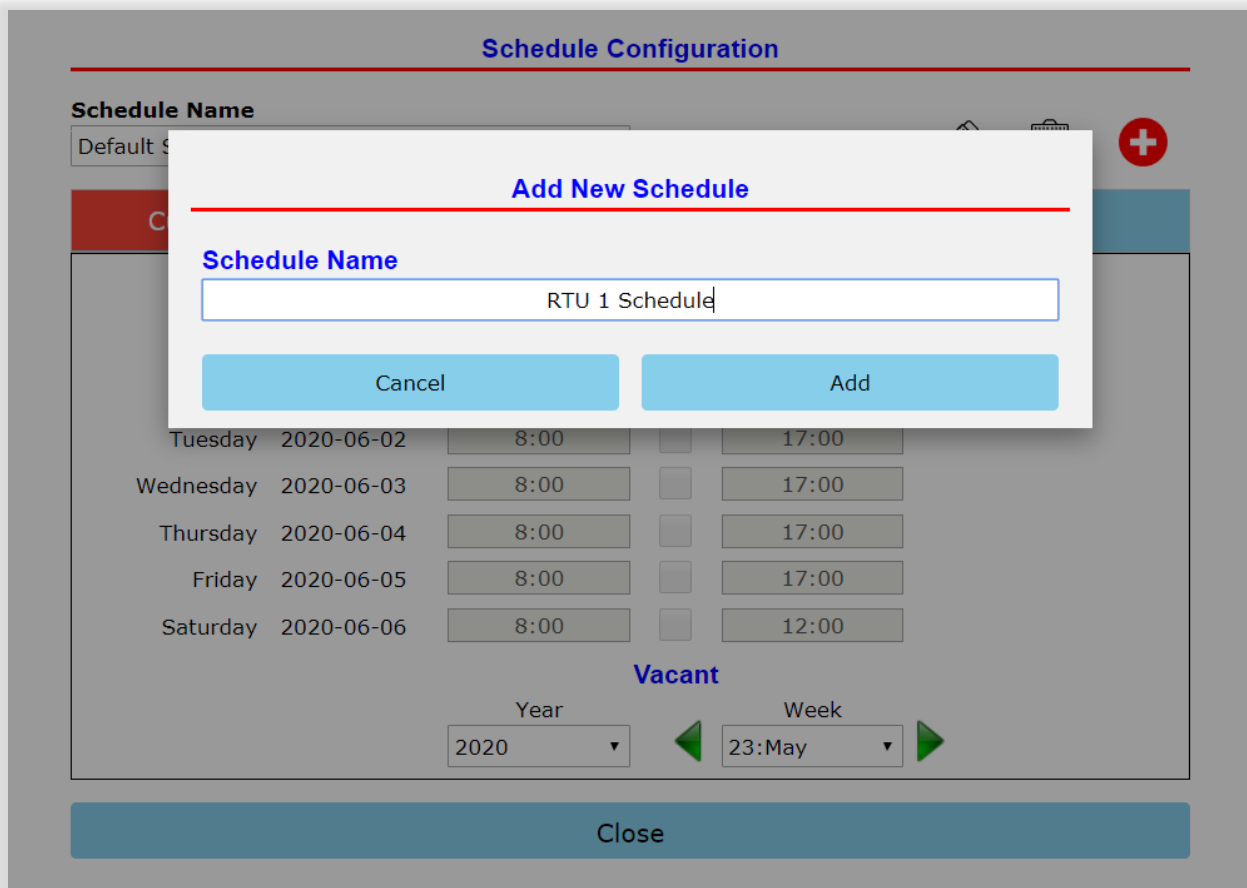

6.4.3.2 Adding Schedules to Sedona

Once you have configured your schedule(s) from the web page, you are ready to drop a Sched component on the Sedona wire sheet and configure it. Multiple Sched components can be dropped and configured for multiple schedules. Enter the Schedule Name (as configured in web page) you would like to bind to the component in the SchedName slot of the Sched component. The configuration from the web page for the given Schedule Name will be bound to that component and the Status slot will change state from InvalidName to Configured when configured successfully.

Schedule component in its default state

Sched 	
CControls_BASCAO2E_Schedule::Sched	
SchedName	
IsOccupied	false
MinToOccupied	0
HeadActive	false
HeadOccupied	false
Status	InvalidName

Schedule component configured

Sched	
CControls_BASCAO2E_Schedule::Sched	
SchedName	RTU 1 Schedule
IsOccupied	true
MinToOccupied	1440
HeadActive	false
HeadOccupied	false
Status	Configured

The IsOccupied slot indicates current state. False indicates unoccupied and true indicates occupied state.

The MinToOccupied slot indicates minutes to occupied state.

The HeadActive and HeadOccupied slots allow for BACnet supervisory commands to be accommodated into the schedule by use of Virtual Point components outputs tied to those slots. A BACnet supervisor (Head End) can control the schedule and the BASpi-Edge could act as a backup to the supervisor, if it becomes disconnected from the controller or unavailable.

To accomplish this logic, setup a Virtual Point which would reset itself. The output of this Virtual Point would go to a one-shot component. The output of the one-shot would go to the HeadActive (supervisor occupied command input). Another Virtual Point, in standard mode would control the HeadActive (head-end active signal). If the head-end stops sending a continuously pulsing signal to the head-end active Virtual Point, then the Sched schedule component takes over. If you don't want to have a head-end control the schedule, and the BASpi-Edge will handle schedules stand-alone, don't use these input slots. The HeadActive signal goes to the false state and the schedule component will be fully in charge of its output. When the head-end is in control of the schedule component, the MinToOccupied slot is not accurate and should not be used.

6.4.3.3 Basic Schedules

The BASpi-Edge also supports a second type of schedules - basic schedules which are inherited from default Sedona control kits. These are not web page configurable and do not allow for events (holidays/exceptions). They are provided in the form of Sedona components only contained in the basicSchedule kit. DailySchedule components, represent a simple daily schedule with up to two active periods. Each active period is defined by a start time and duration. If the duration is zero, the period is disabled. If the periods overlap, then the first period (defined by Start1 and Dur1) takes precedence. If the duration extends past midnight, then the active period will span two separate calendar days. There are two components in the kit — one for Boolean outputs and the other for Float outputs. Both kits rely upon the time being set in the BASpi-Edge Set Time page. Duration periods — Dur1 and Dur2 — are configured in minutes from zero to 1439 minutes.

DailySc 	
basicSchedule::DailyScheduleBool	
Start1	0:0
Dur1	0:0
Start2	0:0
Dur2	0:0
Val1	false
Val2	false
DefVal	false
Out	false

DailyS1 	
basicSchedule::DailyScheduleFloat	
Start1	0:0
Dur1	0:0
Start2	0:0
Dur2	0:0
Val1	0.0
Val2	0.0
DefVal	0.0
Out	0.0

6.5 BACnet Utility

Thanks to its BACnet client functionality, the BASpi Edge can read/write BACnet points over Ethernet or Wi-Fi (depending on Interface option set up in System Configuration under BACnet tab) and BACnet MS/TP devices routed to BACnet/IP, or BACnet MS/TP devices directly connected to the optional EIA-485 to USB dongle (sold separately).

The built-in BACnet Utility allows for reading and writing of BACnet points throughout the BACnet internetwork. This can be very useful to test point reads/writes when integrating BACnet device points into the BASpi-Edge Sedona wire sheet control logic or graphical dashboards. To access the BACnet Utility, click on the BACnet Utility button on the BASpi-Edge main web page.

When Custom is chosen in the Server dropdown menu, the Server Data parameters of BACnet Device Instance and Local IP address (or Device Instance, Router IP, Network, and MAC Address - for routed MS/TP devices) as well as the Object Data parameters of Object Type, Object Instance, and Object Property (such as present value) are entered in manually after which the Read or Write buttons can be used to execute a respective command.

BACnet Utility

Server Data	Object Data
Server Custom	Object Type Analog Input
Routed <input type="checkbox"/> MS/TP <input type="checkbox"/>	Object Instance 5
Device Instance 21388	Object Property Present Value
Local IP 10.0.13.88	Value 77.5
	Status Success
	Read Write
	Close

If BACnet Server devices have been previously set up in the Configure BACnet Servers page under the BACnet tab in the System Configuration page, they will show up in the Server dropdown menu and their Server Data parameters of BACnet Device Instance and Local IP address (or Device Instance, Router IP, Network, and MAC Address - for routed MS/TP devices) are populated automatically based on the setup in Configure BACnet Servers web page. The Object Data parameters of Object Type, Object Instance, and Object Property (such as present value) can be selected, after which the Read or Write buttons can be used to execute a command respectively.

Polled value is shown in the Value field.

Status of Success or Fail is printed in the Status field.

For routed BACnet MS/TP devices to BACnet/IP, enter Router IP, Network number, and MAC Address to access BACnet server objects. For routed BACnet/IP devices which are not MS/TP devices, enter the router IP, network number, and multibyte MAC address with dots between each byte (for example, "29.216.19.04.00.00"). Make sure the MS/TP box is unchecked.

BACnet Utility

Server Data

Server
CubeIO-DO4

Routed MS/TP

Device Instance
421007

MAC Address
7

Object Data

Object Type
Binary Output

Object Instance
1

Object Property
Present Value

Write Priority
10

Value
1

Status
Success

6.6 Azure IoT Central Cloud

6.6.1 Overview

By leveraging open IoT protocols such as MQTT, proven security mechanisms such as Transport Layer Security (TLS), and the robust and easy to use software as a service (SaaS) cloud solution – Azure IoT Central, BASpi-Edge controllers (updated to version 1.0.34.4) can easily and securely connect to the cloud, providing the option to make any attached equipment a cloud-connected asset. BASpi-Edge controllers have a web page configuration for quick and easy cloud connectivity to the Azure IoT Central hosted cloud solution. Cloud connectivity is optional, but it provides excellent global asset management and globally accessible centralized monitoring and supervision capabilities of distributed BASpi-Edge devices. This IoT solution is suitable for multi-site building automation applications, or multi-branch store or retail chain applications. The cloud connection allows the user to upload select, processed, triggered, or all BASpi-Edge point data to the cloud securely where it can be trended, visualized, analyzed, alarmed, and accessed from anywhere – giving your applications the mobility and global accessibility you have been looking for.

6.6.2 Cloud Connection Benefits

The Azure IoT Central web UI lets you monitor device conditions, create rules, and manage devices and their data throughout their life cycle. Furthermore, it enables you to act on device insights by extending IoT intelligence into line-of-business applications.

- Make any attached equipment a cloud connected asset
- Central point of worldwide secure data access – over 56 regions supported by Azure IoT Central SaaS (United States, United Kingdom, United Arab Emirates, Switzerland, Norway, Central Korea, South Korea, North Europe, West Europe, Japan, India, Germany, France, Canada, Brazil, Australia, Asia Pacific, Africa, etc.)
- Fast and easy way for global data monitoring, analysis, and visualization of distributed applications
- Improved mobility/accessibility
- Asset management and supervision
- Predictive/proactive maintenance
- Scalability of operations

Azure IoT Central is a ready-to-use hosted IoT application platform which allows you to focus on your domain expertise rather than the backend plumbing of building an IoT solution from scratch. Microsoft Azure IoT Central is a subset of the Microsoft Azure cloud. However, this “subset” service removes all the regional and scaling complexities of deploying a standard IoT solution while offering over 30 robust and ready-to-use IoT services with easy navigation and configuration which anyone can accomplish without previous cloud application experience. Simply select your region and start connecting BASpi-Edge devices. You can connect one device, ten devices, a hundred devices, or thousands of devices while regional and scalability backend plumbing aspects of IoT deployment will be completely taken care of on your behalf. In addition, app templates can be created to provide starter points for common industry scenarios, so you can simply connect your BASpi-Edge controller and utilize these features to connect your automation application to the cloud without the need for an IoT expert. Multiple user accounts with different accessibility levels/personas (solution builder, operator, administrator, etc.) can be created to provide the proper organizational structure for any application.

6.6.3 Establish an Account, Pricing and Quotas

To connect your BASpi-Edge to the Azure IoT Central hosted IoT application platform, you must first create a free Microsoft account by visiting the [Azure IoT Central](#) page and click on the Free account link.

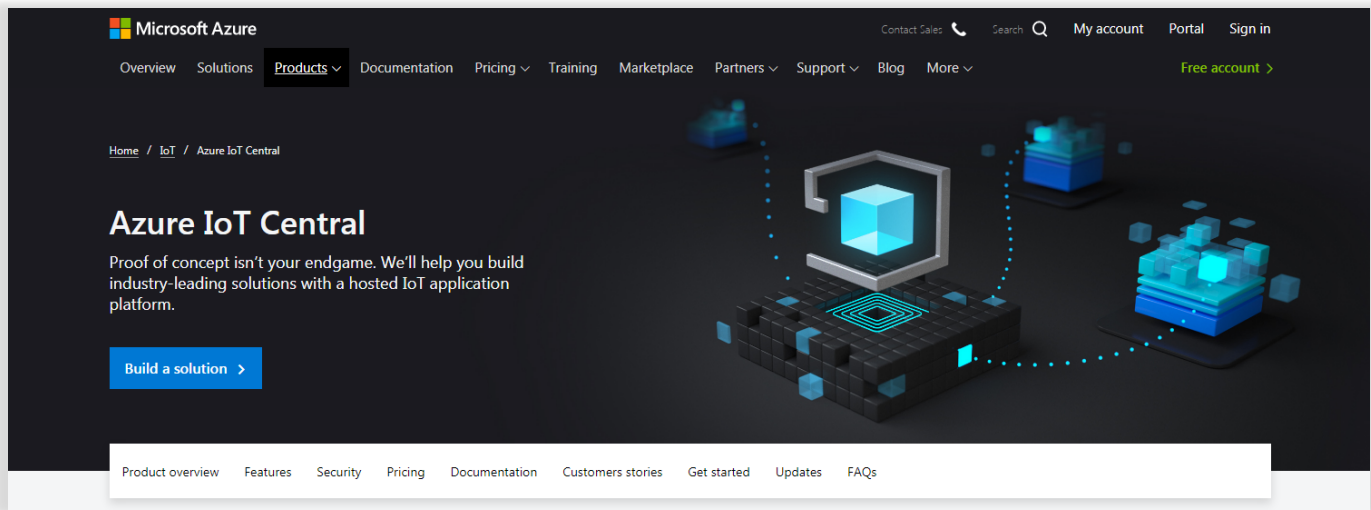

You may already have a Microsoft account if you use any of their software services. Microsoft accounts give you access to many Microsoft Services including the full Azure cloud, Power BI, their office suite, and many others. If a separate, unique account is required for your application, you can create as many accounts as you need to.

The cloud service supported by BASpi-Edge is called **Azure IoT Central**, and it is important to remember this as you go on with the configuration because their website could take you in a different direction due to the many services offered. Azure IoT Central is not a free service, but it does allow you to create an account for free to get started. The benefits of their pricing approach are:

- No upfront cost
- No termination fees
- Pay only for what you need
- Applications you create using the *free* plan are free for seven days and support up to five devices. You can convert them to use a standard pricing plan at any time before they expire.
- Applications you create using the *standard* plan are billed on a per device basis, you can choose either **Standard 1** or **Standard 2** pricing plan with the first two devices being free. Learn more about [IoT Central pricing](#).

You can create IoT Central application using a 7-day free trial or use a standard pricing plan. The cost of cloud activity can vary depending on number of devices and bandwidth. A payment method such as credit card is required to create an account, even though the account is free to create. Depending on promotional periods, Microsoft Azure will sometimes offer a free device connection for a limited time with limited bandwidth and these opportunities are great for trying the cloud for free for a limited time (such as the 7-day free trial). Once the promotional period expires, or the bandwidth limitation is exceeded, the account will be charged using the payment method provided. Cloud connection and data management pricing can vary depending on region and application (messages per minute). To check Azure IoT Central pricing for your region, visit the [Azure IoT Central pricing details page](#). Choose your region and currency and the Pricing Details page will update the chart automatically (US pricing shown in example below quoted in July 2020). Essentially, all BASpi-Edge points could be pushed to the cloud at a 5-minute interval for a very reasonable price per month.

Region:

Central US

Currency:

US Dollar (\$)

Pricing details

New customers can explore the benefits of IoT Central with a free 7-day trial.

PRICING TIER	STANDARD TIER 1	STANDARD TIER 2
Use Case	For devices sending a few messages per hour	For devices sending a message every few minutes
Price per device	\$0.40 per Month	\$0.70 per Month
Monthly device message allocation*	5,000 messages	30,000 messages
Included free quantities per IoT Central application	2 free devices (10,000 included messages)	2 free devices (60,000 included messages)
Overage pricing beyond the monthly message allocation ¹	\$0.015 per 1K messages	\$0.015 per 1K messages

* Total message allocation is shared across all devices in an IoT Central Application

¹ The standard message size is 4KB. For example, if the device sends a 4.5KB message it will be billed as 2 messages.

6.6.4 Establish Cloud Connection

Once the account has been created, you will select Connect Your Device and you will be presented with a set of parameters. A scope ID, a Device ID, a Primary Key, and a Secondary Key (Secondary Key not used in BASpi-Edge). To connect a BASpi-Edge, simply copy and paste these parameters as provided in the Azure IoT Central Connect Your Device page and paste them into the respective fields in the Azure Cloud Configuration web page on the BASpi-Edge.

Azure Cloud Configuration

Poll Rate 60	Scope ID NoScopeID	Device ID NoDeviceID
Operation Triggered	Trigger Point Virtual_Point_1	Primary Key

UIP01 Name: Universal_Input_1 Poll: <input type="checkbox"/> Type: ANALOG_INPUT Direction: To Cloud	UIP02 Name: Universal_Input_2 Poll: <input type="checkbox"/> Type: ANALOG_INPUT Direction: To Cloud	UIP03 Name: Universal_Input_3 Poll: <input type="checkbox"/> Type: ANALOG_INPUT Direction: To Cloud
UIP04 Name: Universal_Input_4 Poll: <input type="checkbox"/> Type: ANALOG_INPUT Direction: To Cloud	UIP05 Name: Universal_Input_5 Poll: <input type="checkbox"/> Type: ANALOG_INPUT Direction: To Cloud	UIP06 Name: Universal_Input_6 Poll: <input type="checkbox"/> Type: ANALOG_INPUT Direction: To Cloud
AOP01 Name: Analog_Output_1 Poll: <input type="checkbox"/> Type: ANALOG_OUTPUT Direction: To Cloud	AOP02 Name: Analog_Output_2 Poll: <input type="checkbox"/> Type: ANALOG_OUTPUT Direction: To Cloud	BOP01 Name: Binary_Output_1 Poll: <input type="checkbox"/> Type: BINARY_OUTPUT Direction: To Cloud

Close Submit

Select a reasonable Poll Rate for your application. 60 seconds is the default Poll Rate. A faster Poll Rate could cost you more in cloud fees (see cost calculation). Choose Poll or Triggered in the Operation dropdown. Poll operation will push all data from a given point to the cloud at the specified Poll Rate. Triggered operation will only push data from a given point on a binary trigger (enable) point chosen from the Trigger Point dropdown every poll period. This Trigger Point will be used to enable pushing data to the cloud. The trigger point can be controlled using Sedona logic, or it could be a binary input channel.

To select which points will be pushed to the cloud, check the Poll checkmark adjacent to any of the physical and/or virtual points listed below. The Direction dropdown has To Cloud and From Cloud options which define whether a point's present value will be pushed to the cloud or written from the cloud respectively. Input channel points and read only/input virtual points can only be pushed to the cloud. Only writeable points can be written to from the cloud.

Azure Cloud Configuration

Poll Rate <input type="text" value="60"/>	Scope ID <input type="text" value="NoScopeID"/>	Device ID <input type="text" value="NoDeviceID"/>
Operation <input type="text" value="Triggered"/>	Trigger Point <input type="text" value="Virtual_Point_1"/>	Primary Key <input type="text" value="....."/>

UIP04 Name <input type="text" value="Universal_Input_4"/> Poll <input type="checkbox"/> Type <input type="text" value="ANALOG_INPUT"/> Direction <input type="text" value="To Cloud"/>	UIP05 Name <input type="text" value="Universal_Input_5"/> Poll <input checked="" type="checkbox"/> Type <input type="text" value="ANALOG_INPUT"/> Direction <input type="text" value="To Cloud"/>	UIP06 Name <input type="text" value="Universal_Input_6"/> Poll <input checked="" type="checkbox"/> Type <input type="text" value="ANALOG_INPUT"/> Direction <input type="text" value="To Cloud"/>
AOP01 Name <input type="text" value="Analog_Output_1"/> Poll <input checked="" type="checkbox"/> Type <input type="text" value="ANALOG_OUTPUT"/> Direction <input type="text" value="To Cloud"/>	AOP02 Name <input type="text" value="Analog_Output_2"/> Poll <input checked="" type="checkbox"/> Type <input type="text" value="ANALOG_OUTPUT"/> Direction <input type="text" value="To Cloud"/>	BOP01 Name <input type="text" value="Binary_Output_1"/> Poll <input checked="" type="checkbox"/> Type <input type="text" value="BINARY_OUTPUT"/> Direction <input type="text" value="To Cloud"/>
BOP02 Name <input type="text" value="Binary_Output_2"/> Poll <input type="checkbox"/> Type <input type="text" value="BINARY_OUTPUT"/> Direction <input type="text" value="To Cloud"/>	BOP03 Name <input type="text" value="Binary_Output_3"/> Poll <input checked="" type="checkbox"/> Type <input type="text" value="BINARY_OUTPUT"/> Direction <input type="text" value="To Cloud"/>	BOP04 Name <input type="text" value="Binary_Output_4"/> Poll <input checked="" type="checkbox"/> Type <input type="text" value="BINARY_OUTPUT"/> Direction <input type="text" value="To Cloud"/>

6.6.5 Cloud Personas

The IoT Central documentation refers to four personas who interact with an IoT Central application:

- A *solution builder* is responsible for defining the types of devices that connect to the application and customizing the application for the operator.
- An *operator* manages the devices connected to the application.
- An *administrator* is responsible for administrative tasks such as managing user roles and permissions within the application.
- A *device developer* creates the code that runs on a device or IoT Edge module connected to your application – the BASpi-Edge built-in cloud connector has taken care of this part for you.

IoT Central applications are fully hosted by Microsoft, which reduces the administration overhead of managing your applications. Administrators manage access to your application with user roles and permissions. To access and use the **Administration** section, you must be in the **Administrator** role for an Azure IoT Central application. If you create an Azure IoT Central application, you're automatically assigned to the **Administrator** role for that application.

In the **Application Settings** page, you can change the name and URL of your application, then select **Save**.

Custom hwdioaey4l

Search

Administration

Application settings

Users

Roles

Pricing

Device connection

API tokens

Customize your application

Customize help

Application template export

Application settings

Application image ⓘ

Select image

Application name *

Custom hwdioaey4l

Application URL * ⓘ

custom-hwdioaey4l

6.6.6 Create your IoT Central application

As a solution builder, you use IoT Central to create a custom, cloud-hosted IoT solution for your organization. A custom IoT solution typically consists of:

- A cloud-based application that receives telemetry from your devices and enables you to manage those devices.
- Multiple distributed devices connected to your cloud-based application.

You can quickly deploy a new IoT Central application and then customize it to your specific requirements in your browser. You can start with a generic *application template* or with one of the industry-focused application templates for Retail, Energy, Government, or Healthcare.

As a solution builder, you use the web-based tools to create a *device template* for the devices that connect to your application. A device template is the blueprint that defines the characteristics and behavior of a type of device such as the:

- Telemetry it sends.
- Business properties that an operator can modify.
- Device properties that are set by a device and are read-only in the application.
- Properties, that an operator sets, that determine the behavior of the device.

This device template includes:

- A *device capability model* that describes the capabilities a device should implement such as the telemetry it sends and the properties it reports.
- Cloud properties that aren't stored on the device.
- Customizations, dashboards, and forms that are part of your IoT Central application.

6.6.7 Customize the UI

As a solution builder, you can also customize the IoT Central application UI for the operators who are responsible for the day-to-day use of the application. Customizations that a solution builder can make include:

- Defining the layout of properties and settings on a device template.
- Configuring custom dashboards to help operators discover insights and resolve issues faster.
- Configuring custom analytics to explore time series data from your connected devices.

6.6.8 Manage your devices

As an operator, you use the IoT Central application to manage the devices in your IoT Central solution. Operators do tasks such as:

- Monitoring the devices connected to the application.
- Troubleshooting and remediating issues with devices.
- Provisioning new devices.

As a solution builder, you can define custom rules and actions that operate over data streaming from connected devices. An operator can enable or disable these rules at the device level to control and automate tasks within the application.

With any IoT solution designed to operate at scale, a structured approach to device management is important. It's not enough just to connect your devices to the cloud, you need to keep your devices connected and healthy. An operator can use the following IoT Central capabilities to manage your devices throughout the application life cycle.

6.6.9 Dashboards

Built-in dashboards provide a customizable UI to monitor device health and telemetry. Start with a pre-built dashboard in an application template or create your own dashboards tailored to the needs of your operators. You can share dashboards with all users in your application or keep them private.

6.6.10 Rules and actions

Build custom rules based on device state and telemetry to identify devices in need of attention. Configure actions to notify the right people and ensure corrective measures are taken in a timely fashion.

6.6.11 Jobs

Jobs let you apply single or bulk updates to devices by setting properties or calling commands.

6.6.12 Integrate with other services

As an application platform, IoT Central lets you transform your IoT data into the business insights that drive actionable outcomes. Rules, data export, and the public REST API are examples of how you can integrate IoT Central with line-of-business applications.

You can generate business insights, such as determining machine efficiency trends or predicting future energy usage on a factory floor, by building custom analytics pipelines to process telemetry from your devices and store the results. Configure data exports in your IoT Central application to export telemetry, device property changes, and device template changes to other services where you can analyse, store, and visualize the data with your preferred tools.

6.6.13 Build custom IoT solutions and integrations with the REST APIs

Build IoT solutions such as:

- Mobile companion apps that can remotely set up and control devices.
- Custom integrations that enable existing line-of-business applications to interact with your IoT devices and data.
- Device management applications for device modeling, onboarding, management, and data access.

6.6.14 Writing data from IoT Central to BASpi-Edge

The BASpi-Edge can receive data from IoT Central when it is connected to the cloud. This data can go to one of the BASpi-Edge’s virtual points. As described in **Section 6.6.4 Establish Cloud Connection**, mark your virtual point’s Direction as being From Cloud.

To write data from IoT Central, first select Devices to select your device, and click Manage Device.

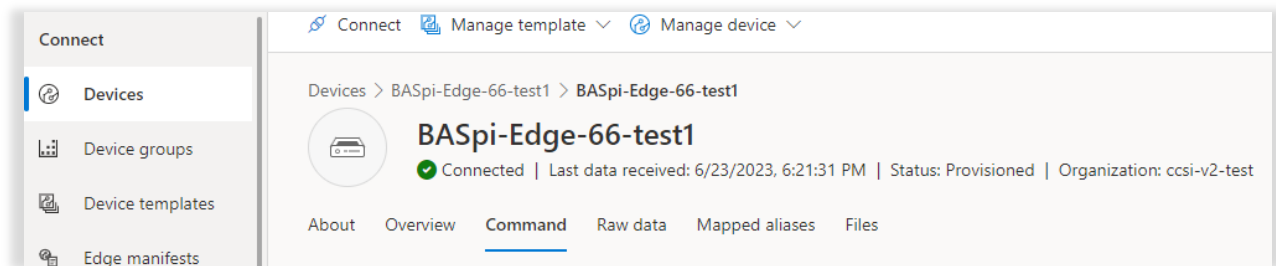

Then, select Command and fill out the command options as shown below. The Method name must be “write.” For Payload, the virtual point name must match the point you wish to control in the BASpi-Edge. You should see a similar Response as shown below. After clicking the Run button, and the status should appear as “success”.

Command ✕

You can use this tool to send commands to a device. Commands have a name, payload, and configurable connection and method timeouts. [Learn more](#) 

Method name * 

Component name 

Payload 

```
1 {
2   "point": "Virtual_Point_4",
3   "value": "3.2"
4 }
```

Connection timeout 

Method timeout 

Queue if offline 

Off

Response 

```
1 {
2   "request": {
3     "methodName": "write",
4     "payload": {
5       "point": "Virtual_Point_4",
6       "value": "3.2"
7     }
8   },
9   "response": {
```

Run

Cancel

6.7 Weather

6.7.1 Overview and Account

The BASpi-Edge supports current weather forecast data obtained from the free weather web service hosted by the openweathermap.org server. A free account can be created allowing the user to obtain an API key, which will then be entered into the API Key field of the BASpi-Edge Weather Configuration web page. To create an account, visit the web site and go through the simple steps of creating an account. All that is required is a valid email address which will be verified. With the account set up and email address verified, log in to your account and click on the API keys tab at openweathermap.org and an API key will be shown (partially blurred in example image below). You can create multiple API keys under Create Key by entering a name and clicking the Generate button. Names can also be edited after the keys have been created. Different API keys can be used in different BASpi-Edge controllers installed at different sites. You can give each API key a name which can be anything that helps you identify keys and their corresponding devices such as BASpi-Edge location name, project name, or anything else that makes sense to you.

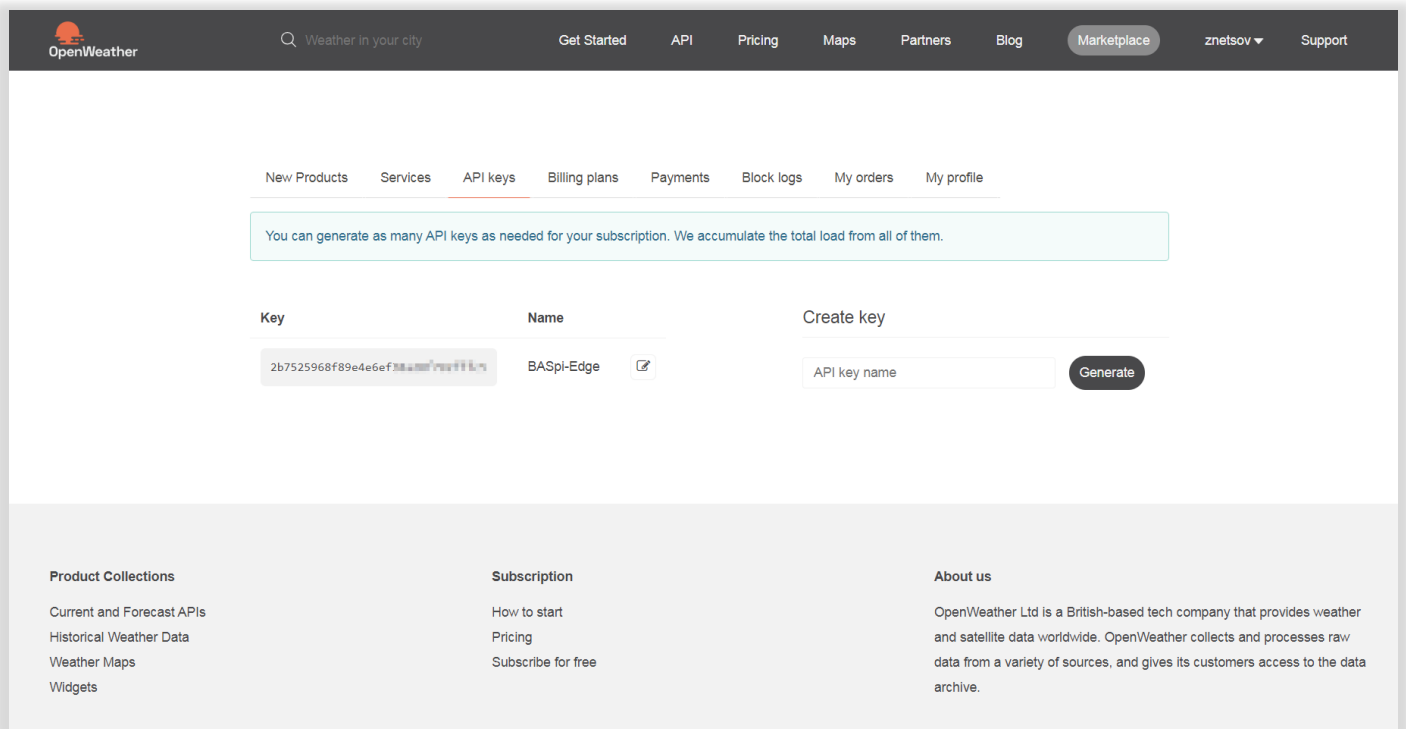

6.7.2 Establish Weather Server Connection

UM-18050000-AA2

Copy the API key provided and paste it into the BASpi-Edge Weather Configuration page. Make sure you have a proper gateway address set up for either the Ethernet or Wi-Fi adapter as well as a proper DNS address. An Internet connection over Ethernet or Wi-Fi is required for BASpi-Edge to query the weather server.

Setting the correct geolocation Latitude and Longitude parameters on the Weather Configuration web page (use the same geolocation configuration as Set Time web page) allows the weather web service to provide timely weather data for the specific location configured.

Choose DegF or DegC from the dropdown for degrees Fahrenheit or degrees Celsius units respectively.

The default Poll Rate of 60 seconds is recommended to maintain the free aspect of the openweathermap.org weather service. Slower poll rates can be used and will not affect your account. Faster poll rates may require a payment method set up with the openweathermap.org weather service.

6.7.3 Assign Virtual Points

Once the API key and Internet connection are configured, weather forecast parameters are bound to Virtual Points and can be used in the Sedona wire sheet control logic, served on BACnet, used in graphical Dashboards, or Cloud dashboards.

Temperature, pressure, humidity, wind speed, wind direction, rainy condition, snow condition, and cloudy condition weather parameters are supported. Each weather condition requires a Virtual Point to be bound to. A Virtual Point can be assigned the Connection weather server data point which indicates the binary state of the weather service connection as 1 for Connected and 0 for Disconnected - this can be used to ignore the weather server data in case of connection loss. A total of 48 Virtual Points are available.

Choose a Virtual Point which is not in use and assign a weather parameter to it by selecting one from the dropdown menu.

Weather Configuration

Poll Rate <input type="text" value="60"/>	Units <input type="text" value="DegF"/>	API Key <input type="text" value="....."/>	<input type="button" value="Test"/>
Latitude <input type="text" value="90"/>		Longitude <input type="text" value="90"/>	

Virtual Points

VT01 Name <input type="text" value="Virtual Point 1"/> Poll <input checked="" type="checkbox"/> BACnet Type <input type="text" value="ANALOG_VALUE"/> Property <input type="text" value="Temperature"/>	VT02 Name <input type="text" value="Virtual Point 2"/> Poll <input type="checkbox"/> BACnet Type <input type="text" value="ANALOG_VALUE"/> Property <input type="text" value="Temperature"/>	VT03 Name <input type="text" value="Virtual Point 3"/> Poll <input type="checkbox"/> BACnet Type <input type="text" value="ANALOG_VALUE"/> Property <input type="text" value="Temperature"/>
VT04 Name <input type="text" value="Virtual Point 4"/> Poll <input type="checkbox"/> BACnet Type <input type="text" value="ANALOG_VALUE"/> Property <input type="text" value="Temperature"/>	VT05 Name <input type="text" value="Virtual Point 5"/> Poll <input type="checkbox"/> BACnet Type <input type="text" value="ANALOG_VALUE"/> Property <input type="text" value="Temperature"/>	VT06 Name <input type="text" value="Virtual Point 6"/> Poll <input type="checkbox"/> BACnet Type <input type="text" value="ANALOG_VALUE"/> Property <input type="text" value="Temperature"/>

Click the Poll checkmark to enable polling the weather web server. Optionally, a name can be entered for each Virtual Point. Repeat the process for as many weather parameters supported as you would like to utilize by selecting Virtual Points to be bound to.

Weather Configuration

Poll Rate <input type="text" value="60"/>	Units <input type="text" value="DegF"/>	API Key <input type="text" value="....."/>	<input type="button" value="Test"/>
Latitude <input type="text" value="41.808919"/>		Longitude <input type="text" value="-88.011175"/>	

Virtual Points

VT43 Name <input type="text" value="Virtual Point 43"/> Poll <input checked="" type="checkbox"/> BACnet Type <input type="text" value="ANALOG_VALUE"/> Property <input type="text" value="Temperature"/>	VT44 Name <input type="text" value="Virtual Point 44"/> Poll <input checked="" type="checkbox"/> BACnet Type <input type="text" value="ANALOG_VALUE"/> Property <input type="text" value="Humidity"/>	VT45 Name <input type="text" value="Virtual Point 45"/> Poll <input checked="" type="checkbox"/> BACnet Type <input type="text" value="ANALOG_VALUE"/> Property <input type="text" value="Wind Speed"/>
VT46 Name <input type="text" value="Virtual Point 46"/> Poll <input checked="" type="checkbox"/> BACnet Type <input type="text" value="ANALOG_VALUE"/> Property <input type="text" value="Wind Direction"/>	VT47 Name <input type="text" value="Virtual Point 47"/> Poll <input checked="" type="checkbox"/> BACnet Type <input type="text" value="ANALOG_VALUE"/> Property <input type="text" value="Rain"/>	VT48 Name <input type="text" value="Virtual Point 48"/> Poll <input checked="" type="checkbox"/> BACnet Type <input type="text" value="ANALOG_VALUE"/> Property <input type="text" value="Clouds"/>
<input type="button" value="Close"/>		<input type="button" value="Submit"/>

Click the Submit button to save all configuration changes and click the Close button to close the Weather Configuration web page. A restart of the controller is required before the weather API configuration becomes active. To restart, click the Restart Controller button, or right click any one of the access buttons on the main web page and select Restart Weather to restart the weather service only or Restart OS to restart the entire BASpi-Edge system. Once configured, the Virtual Points web page will show the weather values obtained from the weather server and the corresponding Virtual Point Sedona components will carry these values into the Sedona wire sheet.

Virtual Points

Virtual Point 25 VT25	0.000	Virtual Point 26 VT26	0.000	Virtual Point 27 VT27	0.000
Virtual Point 28 VT28	0.000	Virtual Point 29 VT29	0.000	Virtual Point 30 VT30	0.000
Virtual Point 31 VT31	0.000	Virtual Point 32 VT32	0.000	Virtual Point 33 VT33	0.000
Virtual Point 34 VT34	0.000	Virtual Point 35 VT35	0.000	Virtual Point 36 VT36	0.000
Virtual Point 37 VT37	0.000	Virtual Point 38 VT38	0.000	Virtual Point 39 VT39	0.000
Virtual Point 40 VT40	0.000	Virtual Point 41 VT41	0.000	Virtual Point 42 VT42	0.000
Current Outside Temperature VT43	80.440	Current Outside Humidity VT44	35.000	Virtual Point 45 VT45	0.000
Virtual Point 46 VT46	0.000	Virtual Point 47 VT47	0.000	Virtual Point 48 VT48	0.000

Auto Refresh ON

NOTES:

1. A GREEN label means that the virtual point has been placed on the wire sheet. The label hover text indicates if the point is configured as "Read from Wire Sheet" or "Write to Wire Sheet"

Close

Virtual Point components with assigned weather parameters can then be dropped on the Sedona wire sheet and utilized in control logic. Virtual Points are automatically served over BACnet and can also be utilized in graphical Dashboards or Cloud dashboards.

OAT	●
CControls BASCAO2E IO::VT43	
Initialized	true
ChnType	FloatInput
Reset	false
FloatV	80.31
BinaryV	true
WireSheet	InputTo

Weather service is completely free as long as the default Weather page Poll Rate configuration in the BASpi-Edge is kept, and account service is limited to 60 calls/minute per account. For additional weather performance, a paid account could be established to support more BASpi-Edge units under the same account and/or make more service calls per minute. Pricing example:

OAH	●
CControls BASCAO2E IO::VT44	
Initialized	true
ChnType	FloatInput
Reset	false
FloatV	35.0
BinaryV	true
WireSheet	InputTo

Free	Startup 40 USD / month	Developer 180 USD / month	Professional 470 USD / month	Enterprise 2,000 USD / month
Get API key	Subscribe	Subscribe	Subscribe	Subscribe
60 calls/minute 1,000,000 calls/month	600 calls/minute 10,000,000 calls/month	3,000 calls/minute 100,000,000 calls/month	30,000 calls/minute 1,000,000,000 calls/month	200,000 calls/minute 5,000,000,000 calls/month
Current Weather Minute Forecast 1 hour* Hourly Forecast 2 days* Daily Forecast 7 days* Climatic Forecast 30 days Bulk Download	Current Weather Minute Forecast 1 hour** Hourly Forecast 2 days** Daily Forecast 16 days Historical weather 5 days** Climatic Forecast 30 days Bulk Download	Current Weather Minute Forecast 1 hour Hourly Forecast 4 days Daily Forecast 16 days Historical weather 5 days Climatic Forecast 30 days Bulk Download	Current Weather Minute Forecast 1 hour Hourly Forecast 4 days Daily Forecast 16 days Historical weather 5 days Climatic Forecast 30 days Bulk Download	Current Weather Minute forecast 1 hour Hourly Forecast 4 days Daily Forecast 16 days Historical weather 5 days Climatic Forecast 30 days Bulk Download
Weather Alerts ^{NEW} based on government warnings. To get access please contact us				
Basic weather maps Historical maps	Basic weather maps Historical maps	Advanced weather maps Historical maps	Advanced weather maps Historical maps	Advanced weather maps Historical maps
Weather triggers	Weather triggers	Weather triggers	Weather triggers	Weather triggers
Weather widgets	Weather widgets	Weather widgets	Weather widgets	Weather widgets
Uptime 95%	Uptime 95%	Uptime 99.5%	Uptime 99.5%	Uptime 99.9%

For complete and up-to-date pricing details visit: <https://openweathermap.org/price#weather>

6.8 Email Configuration

6.8.1 Overview

BASpi-Edge supports multiple email alarms/notifications. Email service uses a Simple Mail Transfer Protocol (SMTP) server to send email messages. A routing email address is required. Multiple emails can be configured to be sent to different email addresses (different individuals). Emails are secure using SSL/TLS encryption on port 587 by default and support most common email servers with security. Unsecure servers are currently not supported. Email alarms/notifications body and subject are customizable. The email body can include the present values of any or all the BASpi-Edge physical and/or virtual points, and up to 3 Sv wire sheet values provided as slots in the Email component. Email alarms/notifications are triggered by a Sedona wire sheet email component. To set up email alarms/notifications, open the Email Configuration page.

Email Configuration

Account

Server

From

Port

User Name

Password

Messages

+

6.8.2 Establish an Account

First, the email alarms/notifications Account information must be set up. This is the SMTP routing and account configuration needed to send emails. You could create a free or paid email account with most standard email providers.

Set up the Simple Mail Transfer Protocol (SMTP) server you will be using in the Server field. For example, smtp.gmail.com or any other free or paid SMTP server provider. Currently, only secure servers are supported. On some email servers, such as Gmail, an app password must be created before emails can be sent. To allow this, sign into the Gmail account using a web browser at <https://mail.google.com>, then go to Account > Security > How you sign in to Google > 2-Step Verification > App passwords. Under App passwords, scroll down to “Select the app and device you want to generate the app password for.” For the dropdown “Select app” choose mail. For the “Select device” dropdown, select Other (Custom Name), provide a unique name, and press the button GENERATE. This will give you a popup with a Generated app password. For security please use this password for the email login password on the Edge unit.

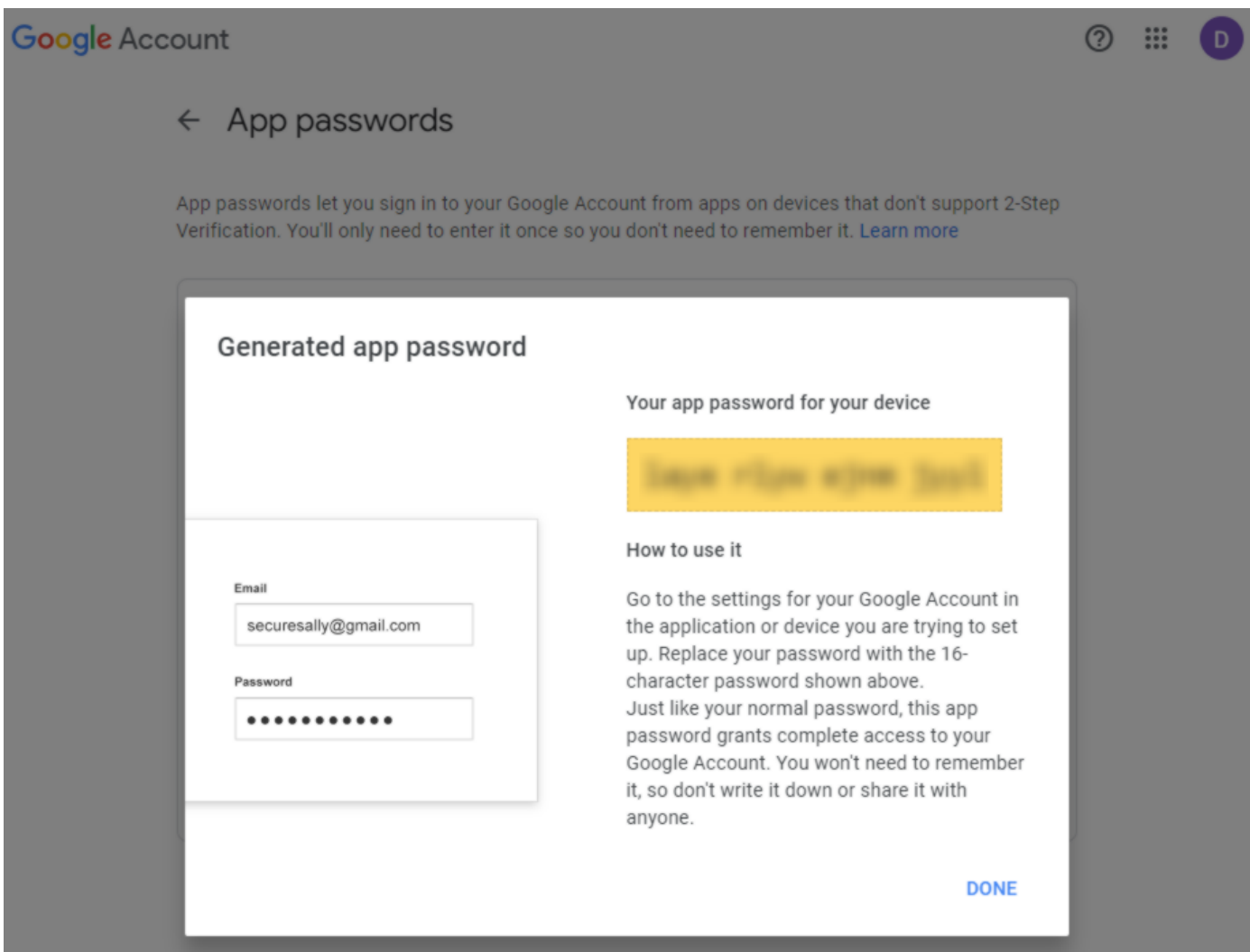

Setup the email address for the originator of email alarms/notifications in the From field. This must be a valid email address and it is the email address the BASpi-Edge email notifications will be originated from and recipients will see. Enter this email address in the From field.

Default Port is 587. Only change Port if you need to. This is the default mail submission port. When an email client or outgoing server is submitting an email to be routed by a proper email server, it should always use SMTP port 587 as the default port. This port, coupled with TLS encryption, will ensure that emails from BASpi-Edge are submitted securely and following the guidelines set out by the IETF.

User Name field is where the username for the originator email address account is entered. This is the same username normally used when logging into that account. You could create different accounts for different job sites if preferred.

Password is the field where the corresponding password for the originator email address account is entered. This is the same password normally used when logging into that account. The password field is obscured so that it cannot be read for security purposes. Make sure it is entered correctly.

Configuration Example:

UM-18050000-AA2

In the example below, recipients of this particular BASpi-Edge email alarms/notifications will receive emails from address: BASpiEdgeSite1@gmail.com. The corresponding username and password for that Gmail account were entered in the Username and Password fields respectively. The default secure port of 587 is used and third party less secure apps access was enabled in the Gmail account settings for that account as described above.

Email Configuration

Account

Server: smtp.gmail.com

From: BASpiEdgeSite1@gmail.com

Port: 587

User Name: BASpiEdgeSite1

Password:

Update

Messages

+

Close

A restart of the controller is required for Account settings to take effect and messages to be sent successfully from the configured account. Click Restart Controller button on the main web page to reboot the service.

6.8.3 Creating Messages

Once the Account information is set up, you are ready to start creating messages to be sent as email alarms/notifications. To create a new message, click the red plus icon at the lower right corner.

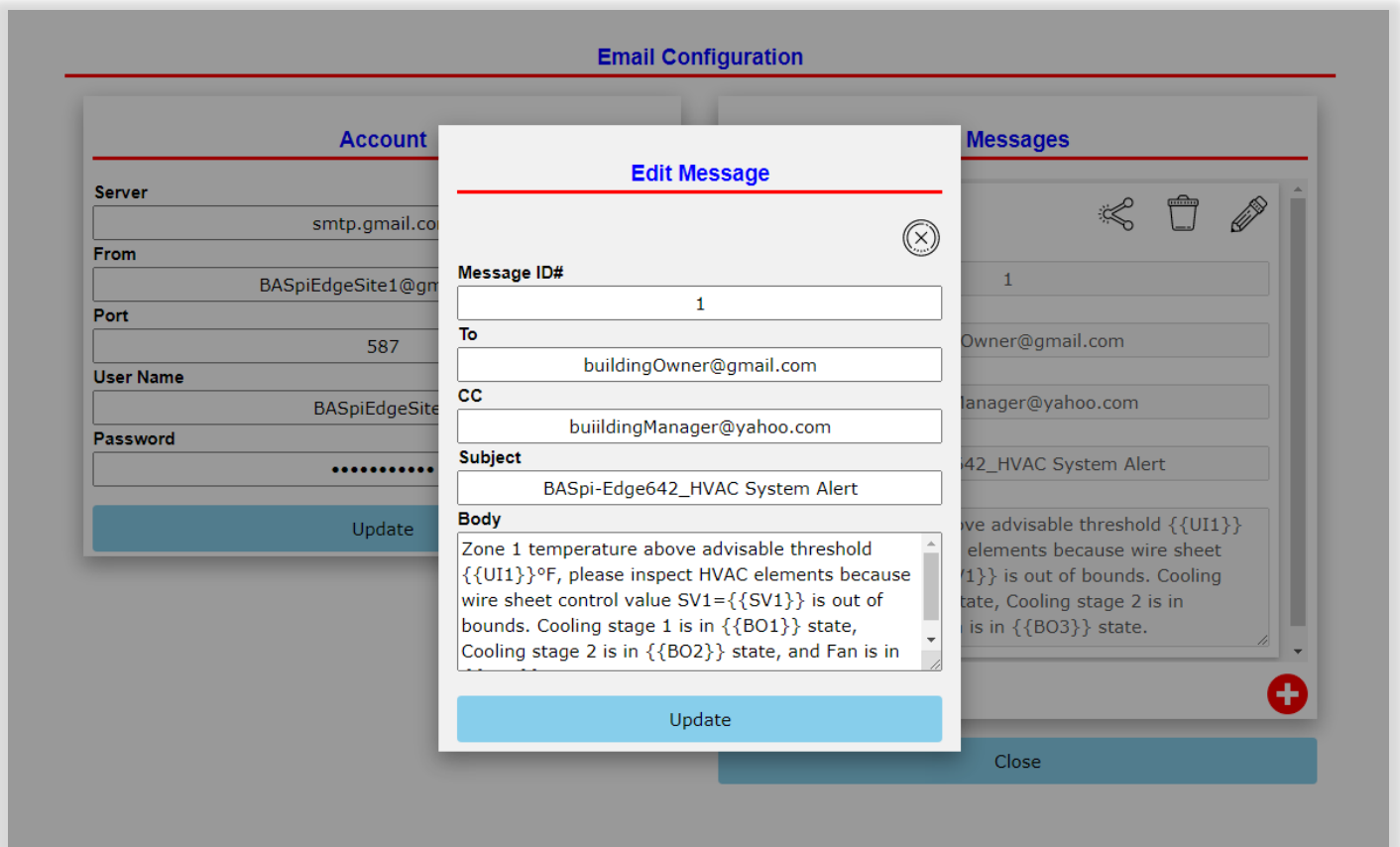

Enter a Message ID# - this can be any numeric value in decimal which will also be used in the email Sedona component which will be bound to this message. When the Sedona component configured with this Message ID# is triggered, the message will be sent. This allows for the use of multiple Sedona email components with different alarms/notifications to different recipients.

The To field is where the recipient's email address for this message is entered. Multiple recipients' email addresses can be entered by separating the addresses with a comma (,).

The CC (aka carbon copy) field is where the secondary recipient's email address for the same message is entered. Multiple recipients' email addresses can be entered by separating the addresses with a comma (,).

The Subject field is where the subject line for the message is entered.

The Body field is where the text content of the message is entered. Enter any content you want recipients to receive. Actual point values sampled at time of triggered sent email can also be included in the email text body. By using curly braces around a point name and instance, BASpi-Edge real, virtual, or up to 3 wire sheet point present values can be included in the sent email. For example:

Zone 1 temperature above advisable threshold {{UI1}} °F, please inspect HVAC elements because wire sheet control value SV3={{SV3}} °F is out of bounds. Wire sheet value SV2={{SV2}} °F. Cooling stage 1 is in {{BO1}} state, Cooling stage 2 is in {{BO2}} state, and Fan is in {{BO3}} state.

{{UI1}} included in the message body will send the present value of Universal Input 3, regardless of what channel type it is configured for. Units or description are not included with the value so they must be added in the text body if needed such as “{{UI1}} °F” for a temperature value or “{{UI1}} V” for a voltage value.

{{AO1}} included in the message body will send the present value of Analog Output 1

{{BO2}} included in the message body will send the present value of Binary Output 2

{{VT44}} included in the message body will send the present value of Virtual Point 44

There are also 3 Sv float value slots per email component – Sv1, Sv2, and Sv3. These slots can be tied directly to wire sheet data and used to send values in the message body which are not physical I/O points or Virtual Points, but values sampled directly from wire sheet logic. In the example below Sv1 is not used, Sv2 has a value of 75.5 and Sv3 has a value of 213.

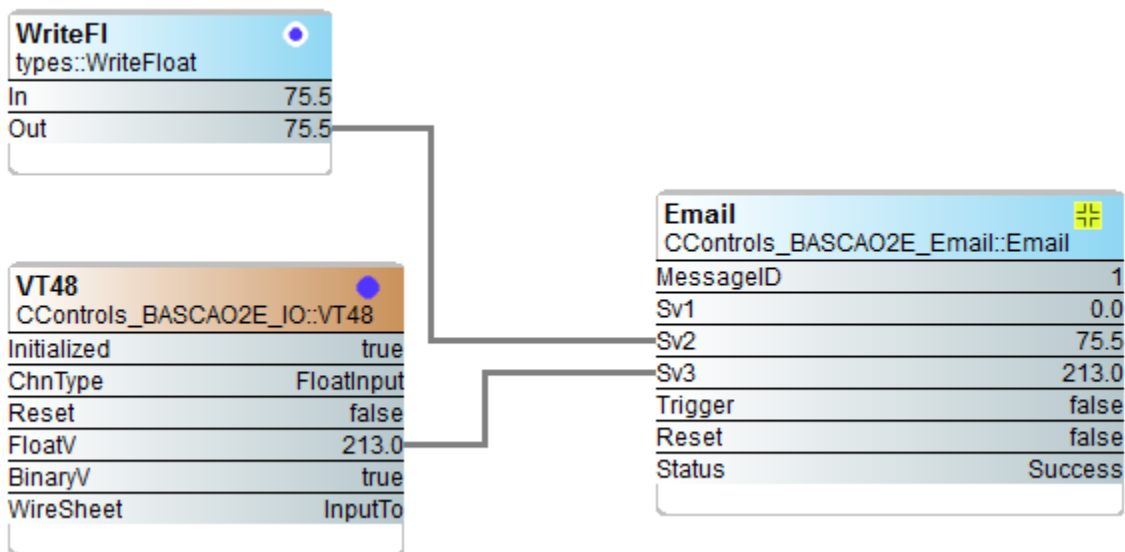

{{SV1}} included in the message body will send the present value of the Sv1 slot of the configured email component id. {{SV2}} included in the message body will send the present value of the Sv2 slot of the configured email component id. {{SV3}} included in the message body will send the present value of the Sv3 slot of the configured email component MessageID. All 3 Sv values can be included in one email by adding all of them in the body using curly braces {{SV1}}, {{SV2}} and {{SV3}}.

If you need to edit a message which was previously configured, click the pencil icon at the top.

To delete a configured message entirely, click the trash can icon at the top and confirm.

Email Configuration

Account

Server

smtp.gmail.com

From

BASpiEdgeSite1@gmail.com

Port

587

User Name

BASpiEdgeSite1

Password

.....

Update

Messages



Message ID#

1

To

buildingOwner@gmail.com

CC

buiildingManager@yahoo.com

Subject

BASpi-Edge642_HVAC System Alert

Body

Zone 1 temperature above advisable threshold {{UI1}} °F, please inspect HVAC elements because wire sheet control value SV1={{SV1}} is out of bounds. Cooling stage 1 is in {{BO1}} state, Cooling stage 2 is in {{BO2}} state, and Fan is in {{BO3}} state.



Close

To force a send in order to test a message alert, click the triple node (share) icon at the top. A small pop-up window will be displayed with Status: IDLE.

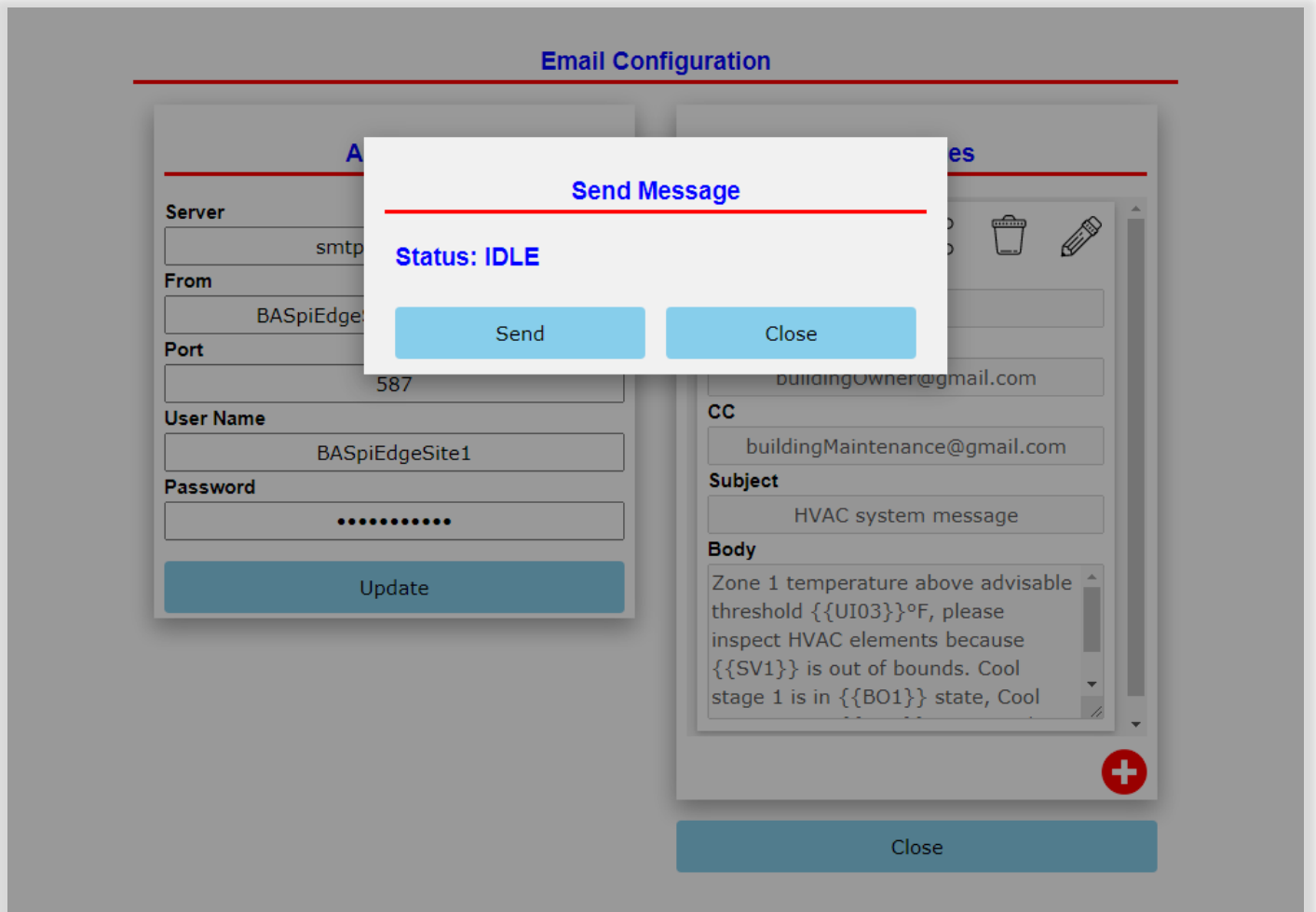

Click the Send button to force an email. Status will change to PENDING and upon a successful send, it will change to SUCCESS, if it fails, it will change to FAIL. On Status: SUCCESS, the message will be forcefully sent (not automatically triggered by Email Sedona component) to the configured recipients. This can be used to test email alerts setup.

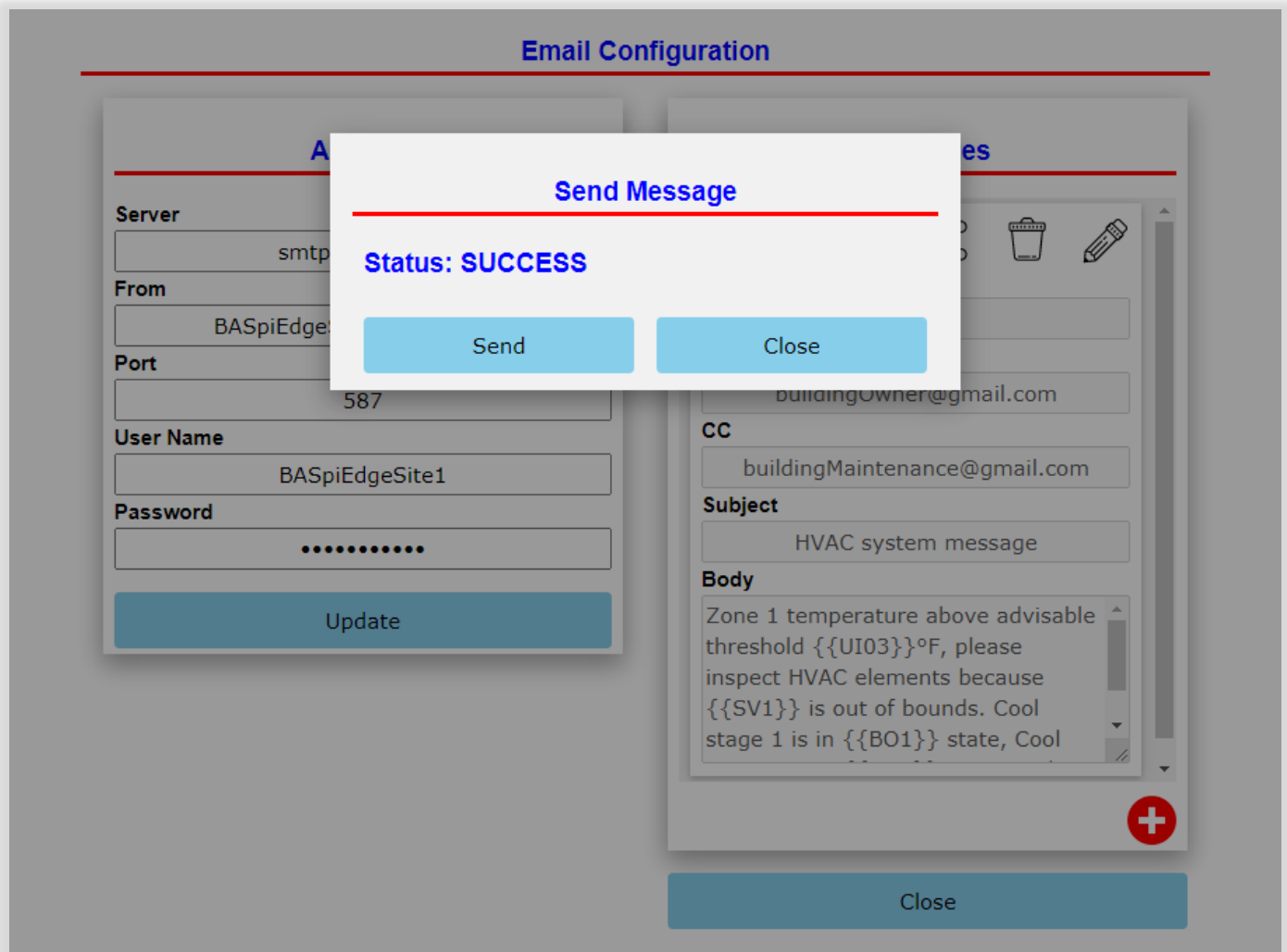

NOTE: Sv wire sheet values {{SV1}}, {{SV2}} and {{SV3}} included in Body are only sent when the Email Sedona component is triggered to true state. These values will not be sent when the message is forced from the web page using the triple node (share) icon at the top.

To create another message with different MessageID#, click the red plus icon at the bottom. MessageID# numbers must be unique for each configured message bound to a Sedona Email component.

6.8.4 Email Component Configuration

Once the message is configured, you are ready to bind an email component to the configured message by using the Message ID#.

Email	
CControls_BASCAO2E_Email::Email	
MessageID	
Sv1	0.0
Sv2	0.0
Sv3	0.0
Trigger	false
Reset	false
Status	InvalidID

The email component is available in the CControls_BASCAO2E_Email kit for BASpi-Edge 6/4/2 and CControls_BASCPiE_Email kit for BASpi-Edge 6/6. Drag and drop the Email component on the wire sheet to begin configuration.

Enter the MessageID for the message of interest (if multiple exist) created in the web page which you would like to bind the Email component to. Once an existing MessageID# is entered in the MessageID slot, the Status slot will change state from InvalidID to Success.

Email	
CControls_BASCAO2E_Email::Email	
MessageID	1
Sv1	0.0
Sv2	0.0
Sv3	0.0
Trigger	false
Reset	false
Status	Success

The Trigger slot is a binary value which when triggered to true state will initiate the email send. The next email alarm/notification will not be sent until this slot goes back to false condition and then true again to initiate the next send (sends on rising edge).

The Status slot will change state to Pending while the email service is in the process of sending a message and it will print Success in the Status slot again once the message has been sent successfully. If the message send fails, Failure will be printed in the Status slot. The email component

will not retry to send email alerts in the case of Status slot = Failure until the Email component has been reset by toggling the Reset slot to true.

The Status slot has an Integer (Int) data type output and this provides means to create additional logic to drive the Reset slot to true in case of Failure Status.

Status = 0 for Success

Status = 1 for Failure

Status = 2 for Pending

Sv1, Sv2, and Sv3 slots can be used to tie wire sheet values to. These values can be included in the email by using curly braces around each slot name such as: {{SV1}}, {{SV2}}, or {{SV3}}. All 3 values can be included in the email message body if needed.

Successfully received email alert message example:

Zone 1 temperature above advisable threshold 79.600°F, please inspect HVAC elements because wire sheet control value SV3=213.000°F is out of bounds. Wire sheet value SV2=75.500°F. Cooling stage 1 is in 1 state, Cooling stage 2 is in 0 state, and Fan is in 1 state.

6.9 Restart Controller

BASpi-Edge firmware can be restarted using the Restart Controller button on the main web page.

The Restart Controller button only restarts selective services after configuration changes have been made to those services. It only takes a couple of seconds to restart services. In order to force a complete system restart, right click on any of the main web page access buttons and select Restart OS.

To Restart a specific service such as cloud or weather, or to restart the Linux operating system, right-click on the Restart Controller button or any of the web page buttons at the bottom and select one of the Reset options (shown below).

Restart OS – restarts the Linux operating system with all associated services – complete system restart.

Restart Cloud – restarts cloud service only.

Restart Weather – restarts weather service only.

NOTE: Sedona logic is paused during Restart of BASpi-Edge controller. Physical inputs/outputs will remain in last known state before the Restart while the system is rebooting. Once system is restarted, Sedona logic resumes normal operation.

The screenshot displays the BASpi-Edge 6/4/2 web dashboard. At the top, there are three columns: Universal Inputs, Analog Outputs, and Binary Outputs. Each column contains several input/output points with their current values and status indicators. Below this, the title 'BASpi-Edge 6/4/2' is prominently displayed. At the bottom, there is a navigation bar with buttons for System Config, System Status, MS/TP Status, Set Time, Virtual Points, and Web Components. The Web Components button is highlighted, and a context menu is open over it, showing options: Restart OS, Restart Weather, and Restart Cloud. Below the navigation bar, there is an 'Auto Refresh OFF' indicator and copyright information for Contemporary Control Systems, Inc.

Universal Inputs		Analog Outputs		Binary Outputs	
UI1 Zone Temp Input 1	65.520°F	AO1 Analog Output 1	8.500	BO1 Binary Output 1	1
UI2 Occupancy Input 2	0	AO2 Analog Output 2	7.500	BO2 Binary Output 2	1
UI3 Universal Input 3	0.000			BO3 Binary Output 3	0
UI4 Zone Temp Input 4	68.290°F			BO4 Binary Output 4	0
UI5 Universal Input 5	0.000				
UI6 Universal Input 6	0.000				

BASpi-Edge 6/4/2

System Config | System Status | MS/TP Status | Set Time | Virtual Points | Web Components

Schedule | BACnet Utility | Cloud | Weather | Email | Restart Controller

Dashboard

Auto Refresh OFF

Restart OS
Restart Weather
Restart Cloud

Copyright 2020 Contemporary Control Systems, Inc. All rights reserved
Firmware Revision 1.0.31.6 : Web Page Revision 7.0.5
NOTE: A GREEN label indicates that the I/O point has been placed on the wire sheet

7 Graphical Dashboard

7.1 Web-based Setup

Graphical dashboards allow you to easily visualize your automation application and/or provide a human-machine interface. BASpi-Edge graphical dashboards can be configured and customized using a web page and accessed over Ethernet, or Wi-Fi, or directly out of the resident HDMI port. A built-in library of graphical widgets such as gauges, charts, sliders, or buttons is used to display and/or control BASpi-Edge point values.

Dashboards are accessible over the IP network, but can also be displayed on an HDMI-connected screen. HDMI screens require an HDMI cable connection. If a touchscreen is used to connect to the HDMI port, an additional USB connection allows for touch control on graphical widgets tied to writable points as well as some page scroll action if many widgets are used and cannot all fit on a single page of the screen.

7.1.1 Begin Dashboard Design

To design a graphical dashboard, click the Dashboard access button on the main web page. You will be taken to a black screen with a small wrench icon at the top.

Click the small wrench icon at the top to begin dashboard configuration. The wrench icon is only shown when the dashboard is accessed over an IP connection. The wrench icon is not shown when an HDMI screen is connected.

NOTE: BASpi-Edge IP address and Channel Configuration, specifically channel names (point names) must be configured prior to designing a Dashboard. The Dashboard uses this configuration to create, obtain and update data used in the Dashboard.

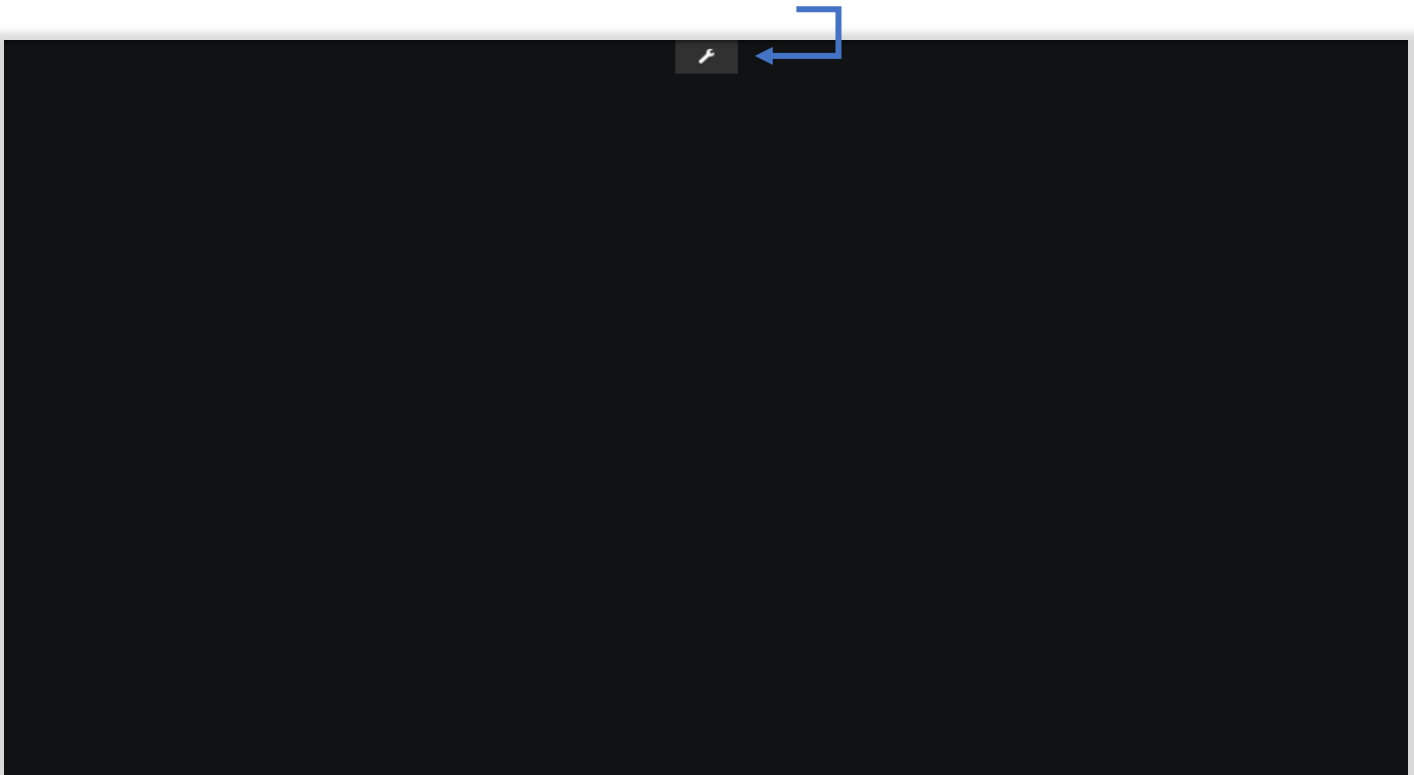

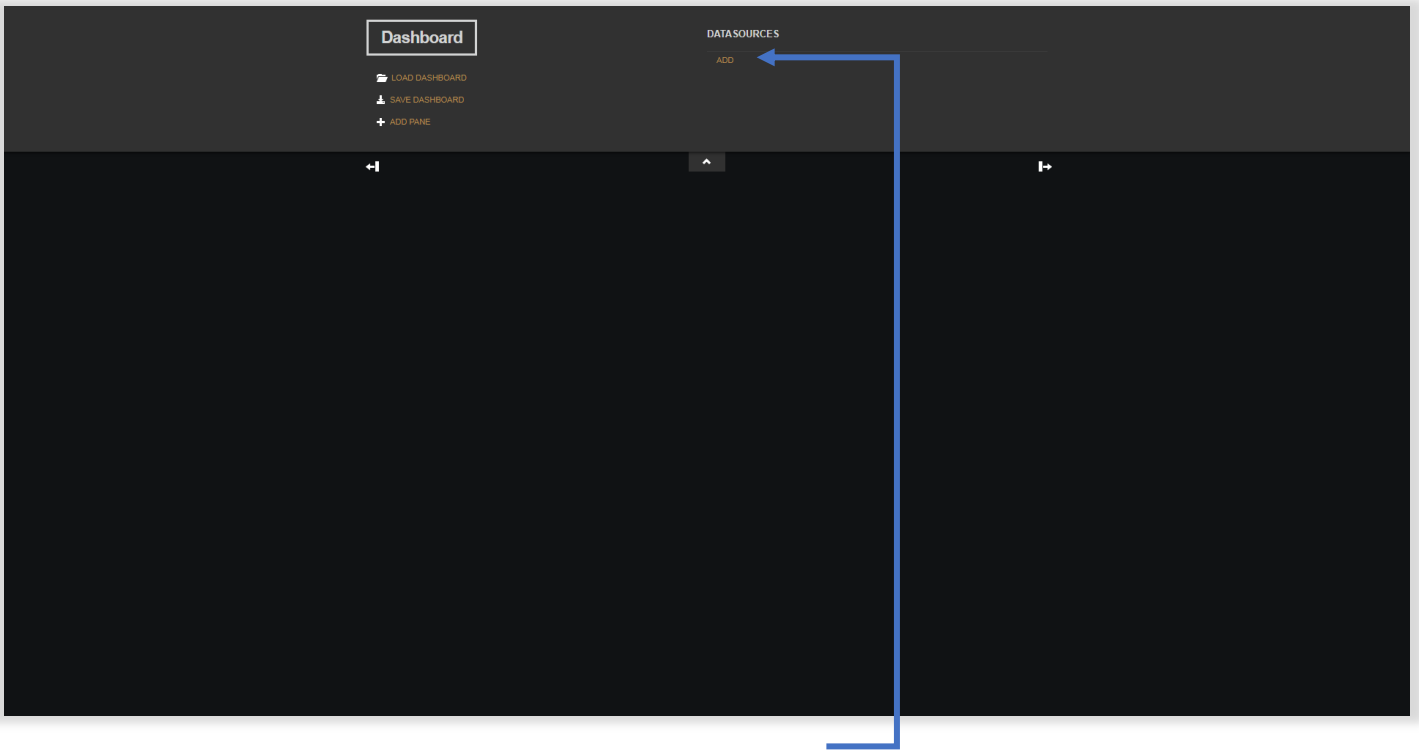

7.1.2 Add Data Source

Click on Add button under Data Sources for the dashboard and choose BASpi-Edge from the Type dropdown menu.

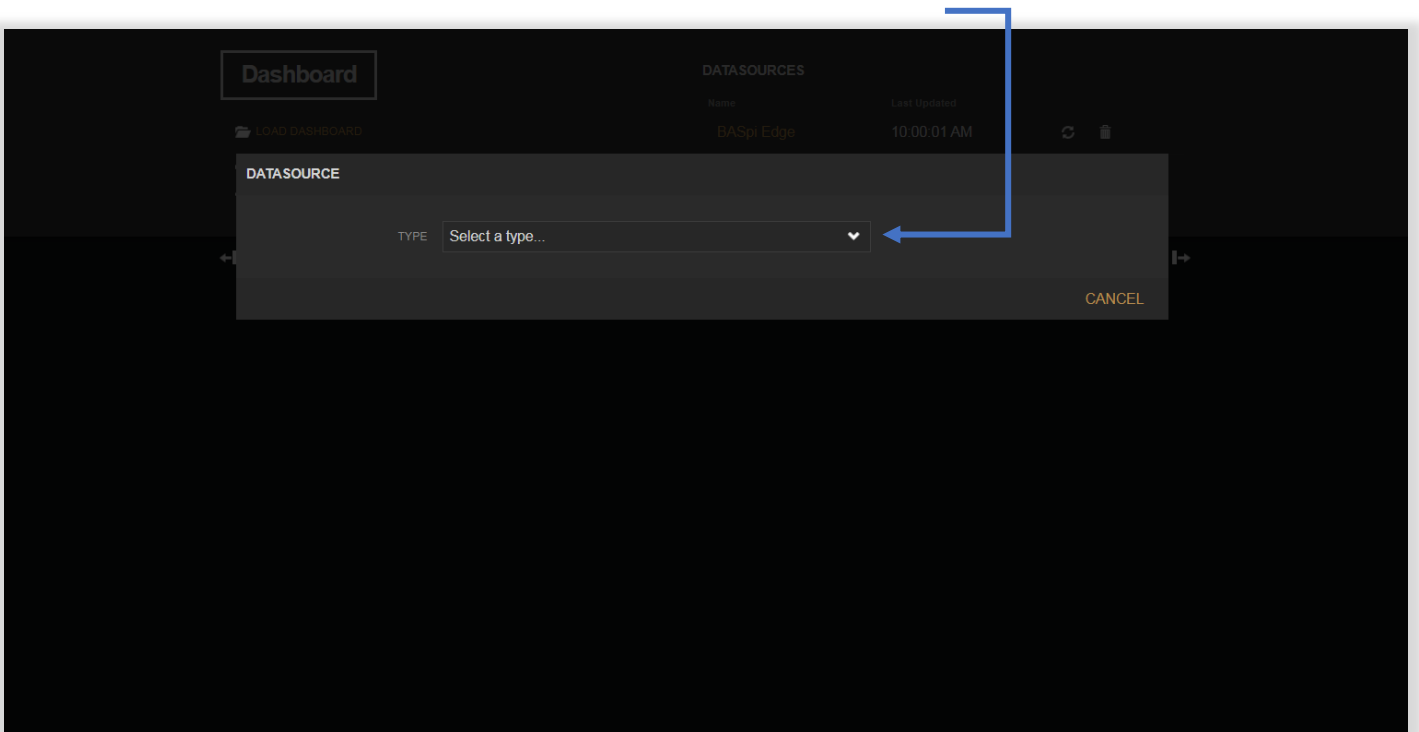

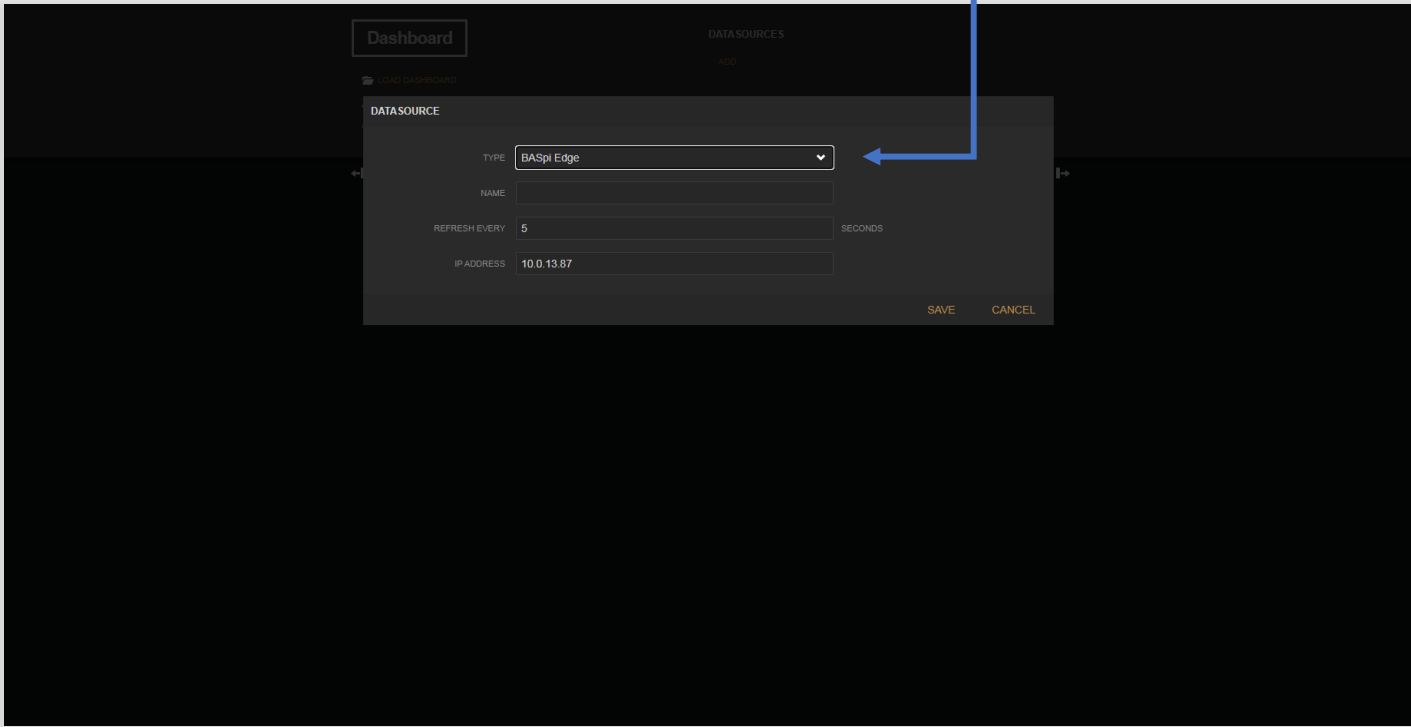
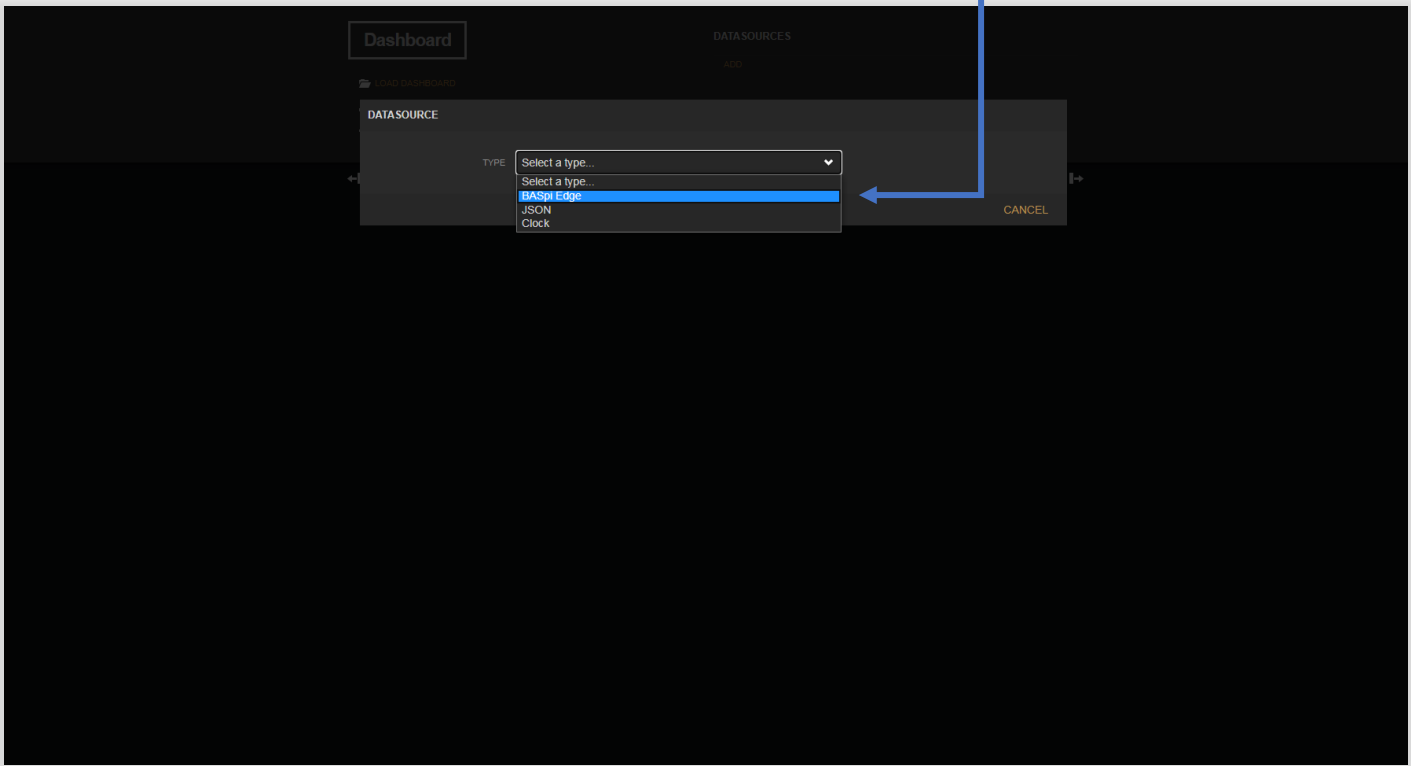

7.1.3 Name Data Source

Once selected, give the BASpi-Edge data source a name. The refresh rate is set to 5 seconds by default, but it can be configured for a minimum value of 1 second if faster response for graphical widgets is required. The IP address is the same as BASpi-Edge configured IP address and will be populated automatically.

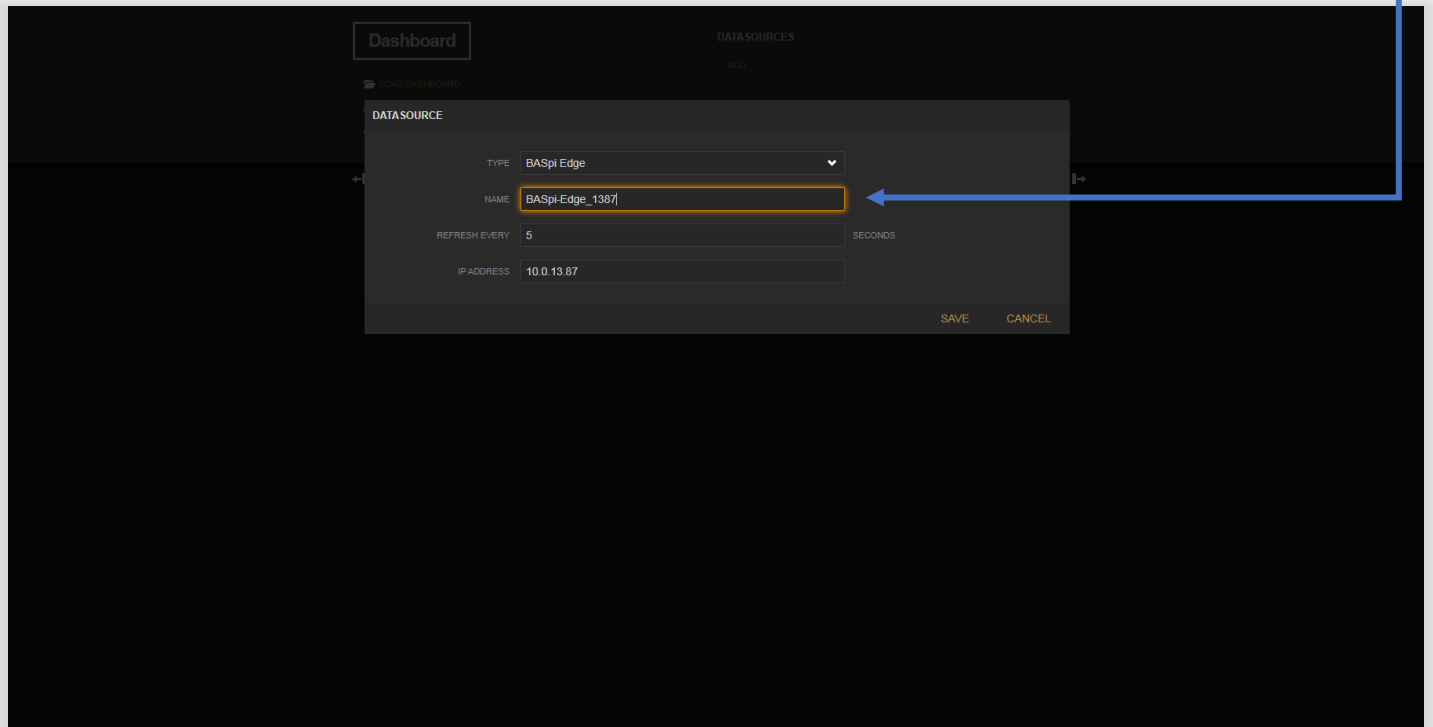

NOTE: If BASpi-Edge IP address changes, it will have to be manually changed in the Dashboard Data Source configuration. Use of static IP addressing is recommended.

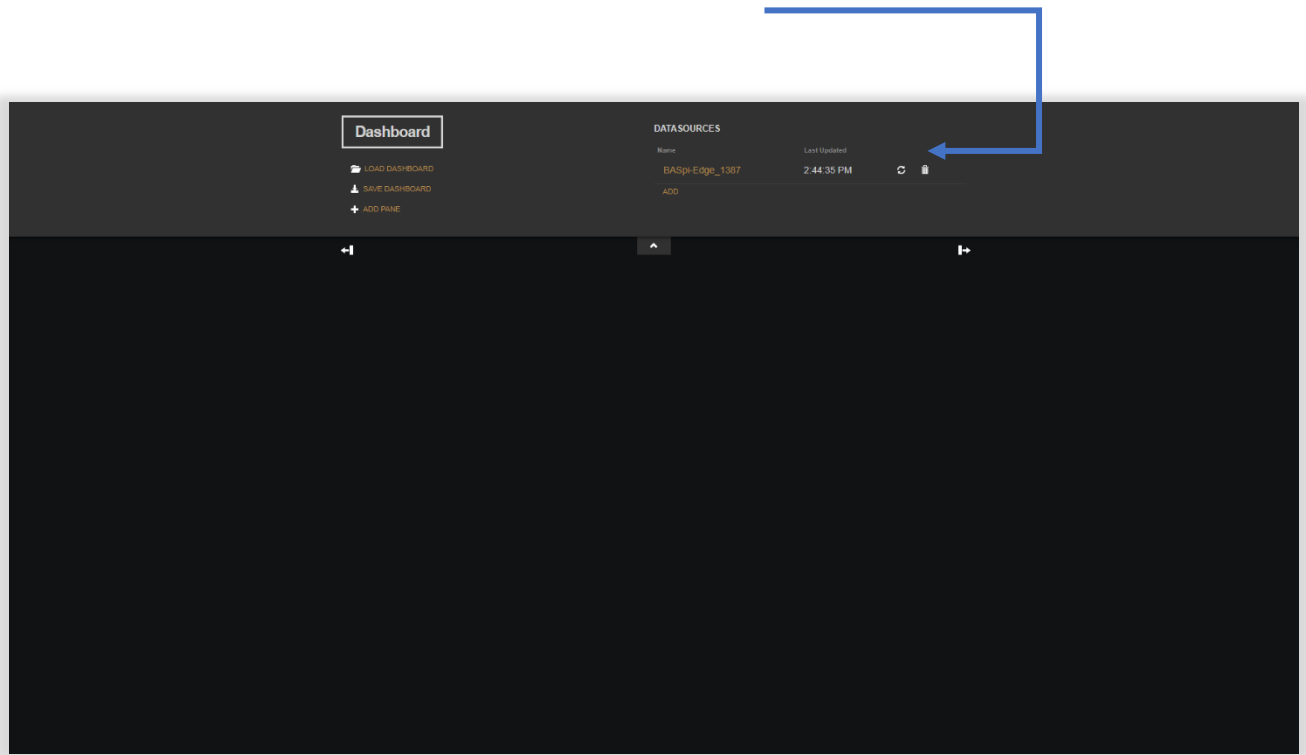

Click Save to save Data Source configuration. On successful Data Source configuration, the Last Updated time printed next to the BASpi-Edge data source will update to the current local time. This indicates the dashboard has successful communication with the data source. The circular arrow icon can be used to refresh data source and the trashcan icon can be used to delete it.

7.1.4 Dashboard Design

To begin designing your dashboard, click the Add Pane button and a new pane (widgets container) will appear on the dashboard. Panes are used to organize graphical widgets and function as widget containers. Panes can be freely positioned on the screen by clicking at the top area and dragging with the mouse.

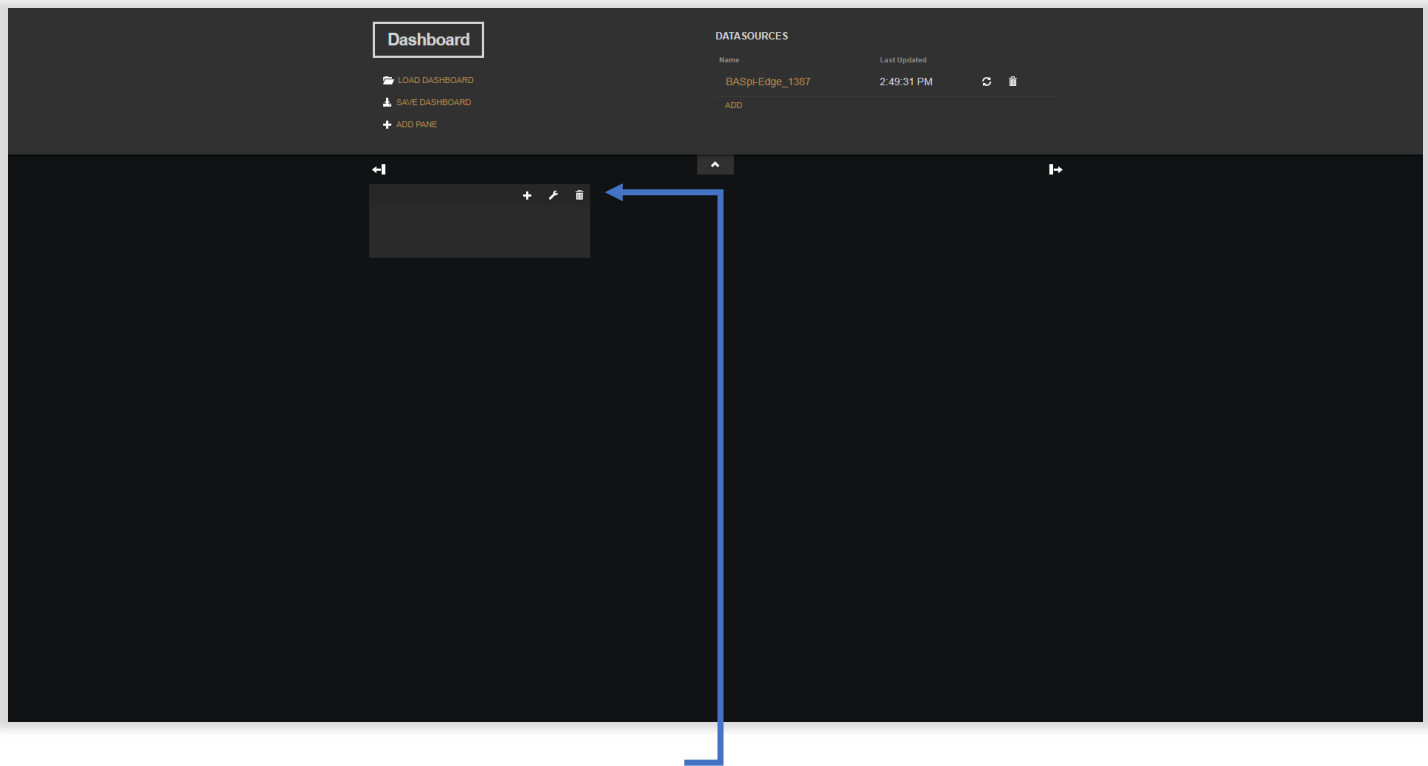

Each Pane will have 3 icons at the top right corner – a plus icon, a wrench icon, and a trashcan icon. The wrench icon allows you to configure some pane settings such as its name and number of columns. This pane is named “Analog Outputs” in the example and it will display gauges indicating BASpi-Edge analog outputs states.

Click Save to save any pane setting changes and close the pane settings window.

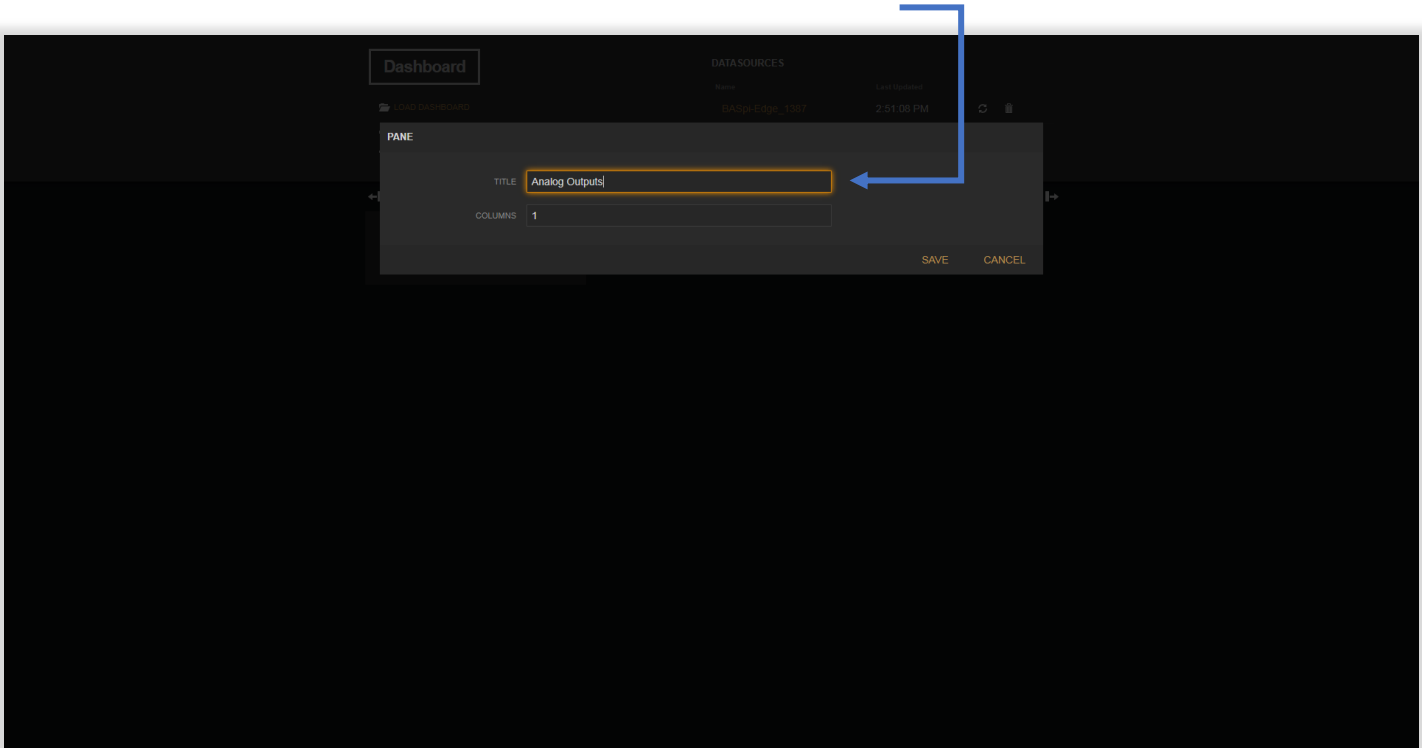

The plus icon on a pane is used to add graphical widgets to the given pane. Click the plus icon and choose a graphical widget from the dropdown selection.

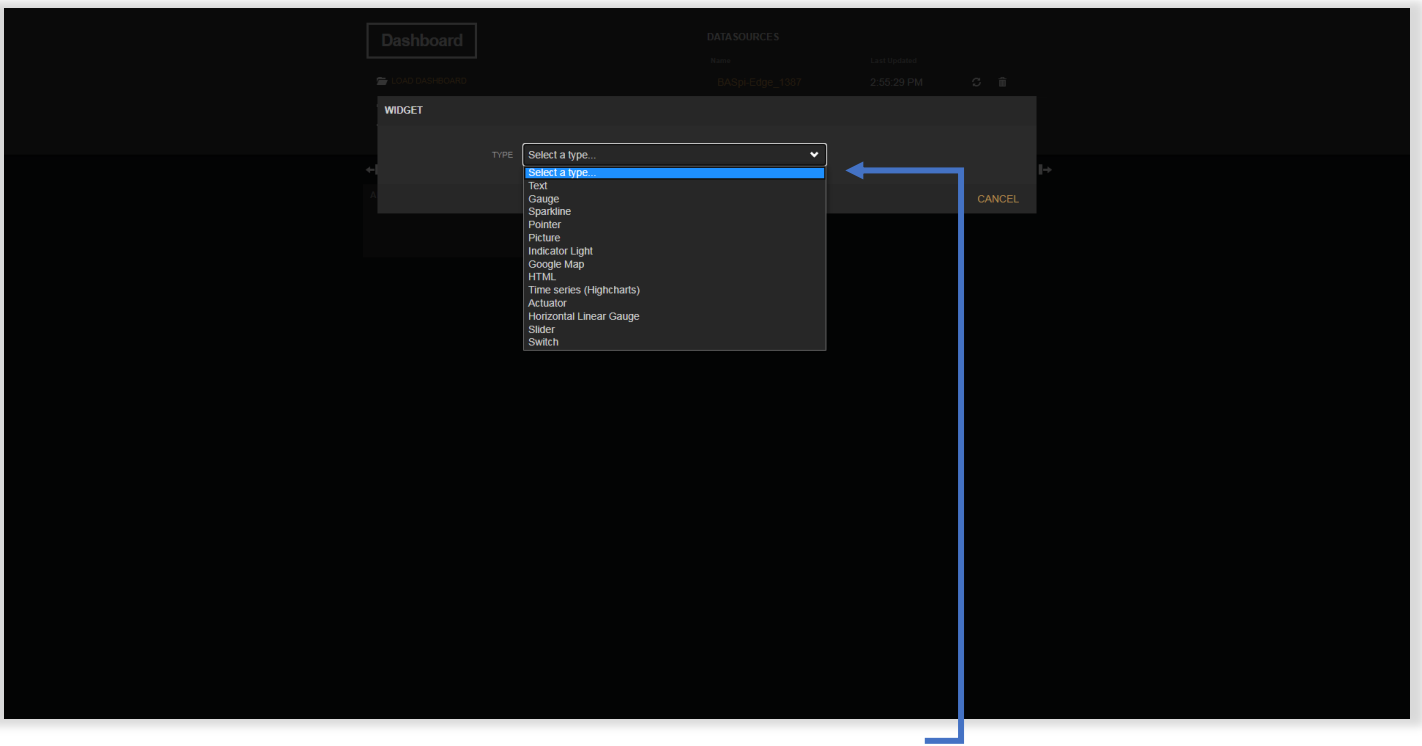

Once a widget is selected, it must be configured for one of the available BASpi-Edge points. All 12 physical I/O points as well as all 48 Virtual Points can be utilized in Dashboards. Web Components cannot be utilized in

Dashboards. Give the selected widget a name and then click on the + Data Source button next to value. Select the previously configured Data Source (BASpi-Edge_1387 in example).

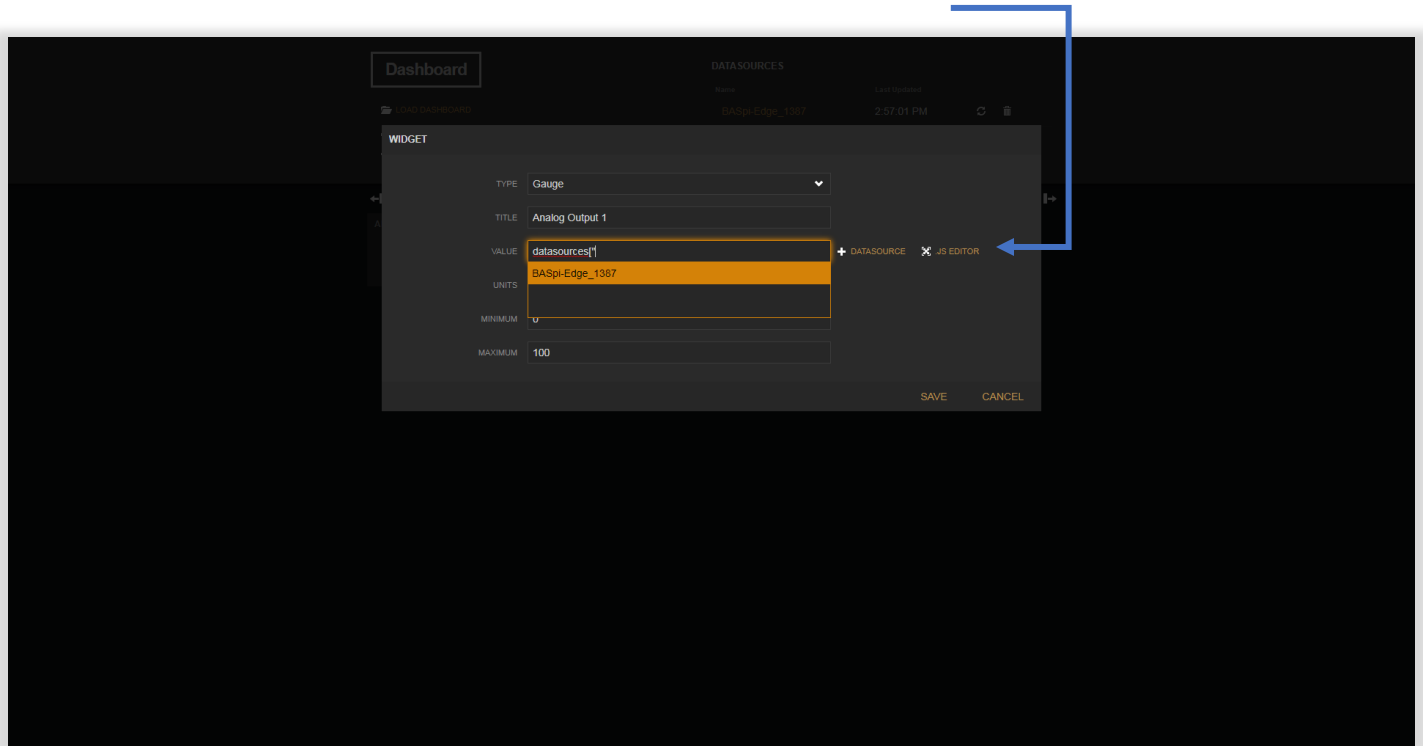

7.1.5 Choose Data Sources

Once you click on the configured data source, the Value field will begin to populate, and the data source available points will be shown in the dropdown next.

Points are listed in the same order as seen on BASpi-Edge main web page.

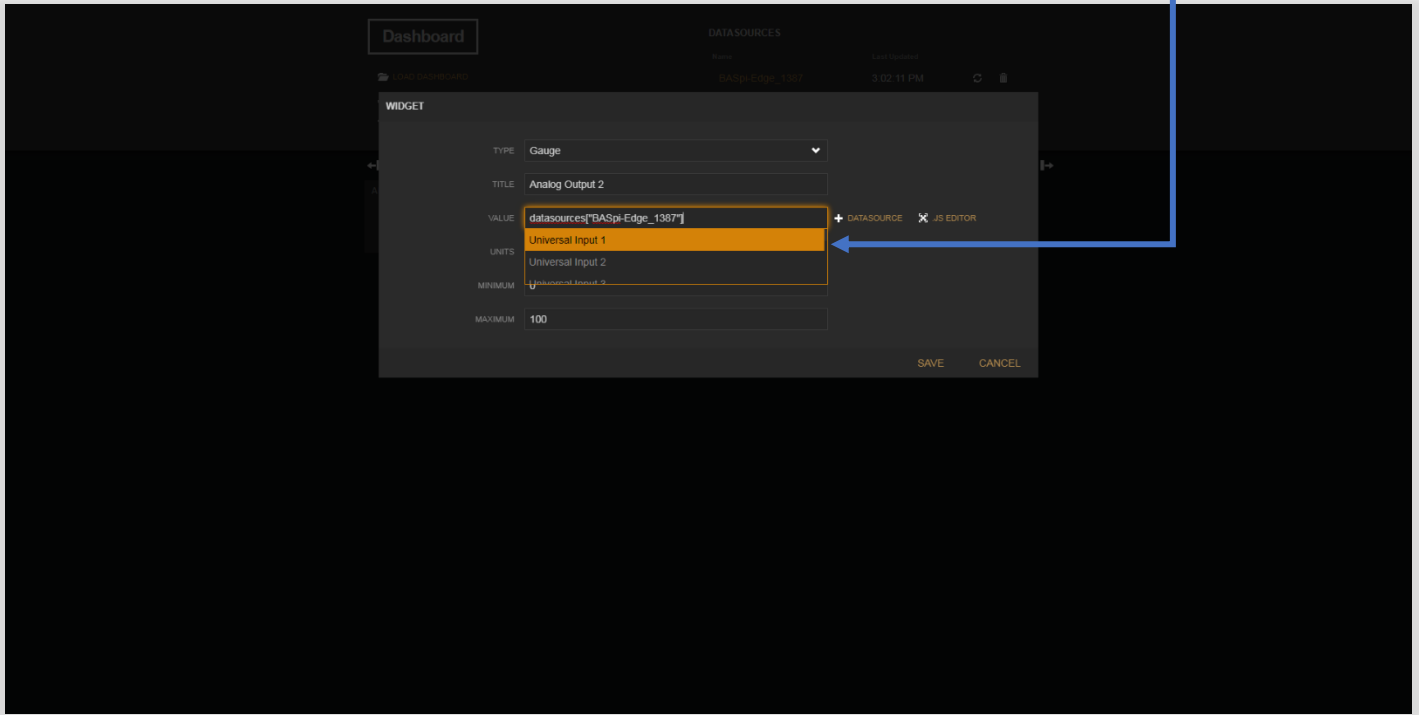

Scroll up/down the points list if necessary and choose a point of interest to be bound to the widget (Analog Output 2 in example). Point names can also be manually edited. For example, once `datasources[\"BASpi-Edge_1387\"][\"Analog Output 2\"]` is entered, it could easily be edited to `datasources[\"BASpi-Edge_1387\"][\"Analog Output 1\"]` by using the keyboard input. In addition, once you begin typing a point name, it will be displayed in the dropdown below automatically if that point name exists in the data source selected.

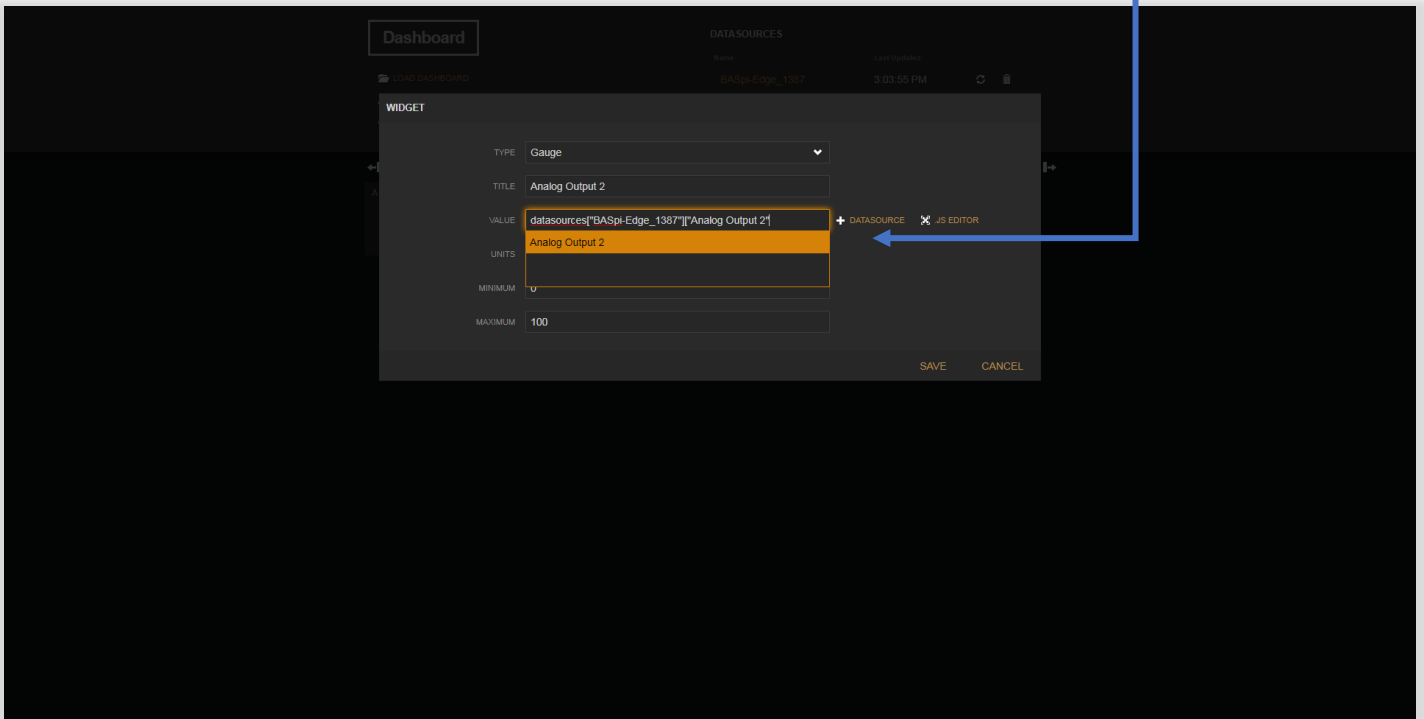

7.1.6 Create a Widget Pane

Assign Units, Minimum, and Maximum values for the point widget. In this example, analog outputs can be driven from 0 V to 10 V, therefore we enter V for Units, 0 for Minimum, and 10 for Maximum values.

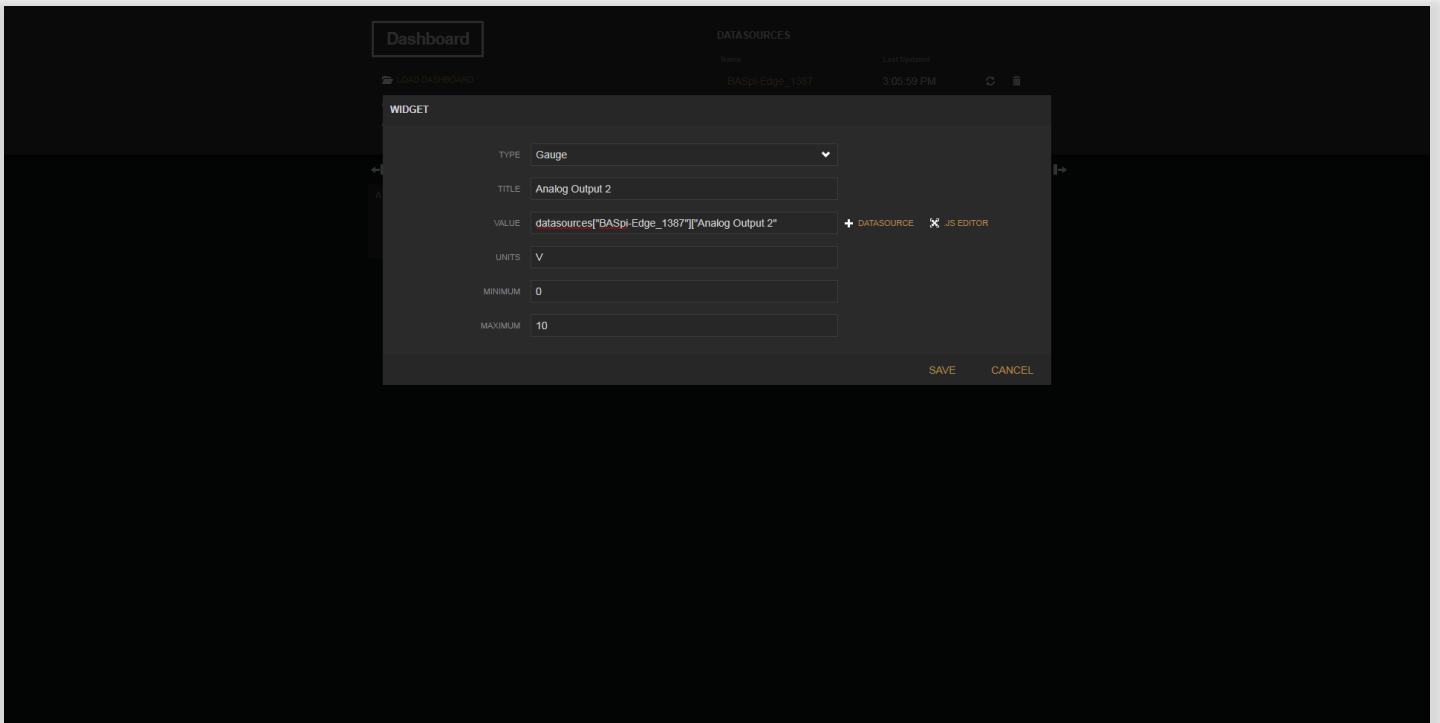

Click Save button and the Widget will be created in the pane and its value will be updated in the specified interval.

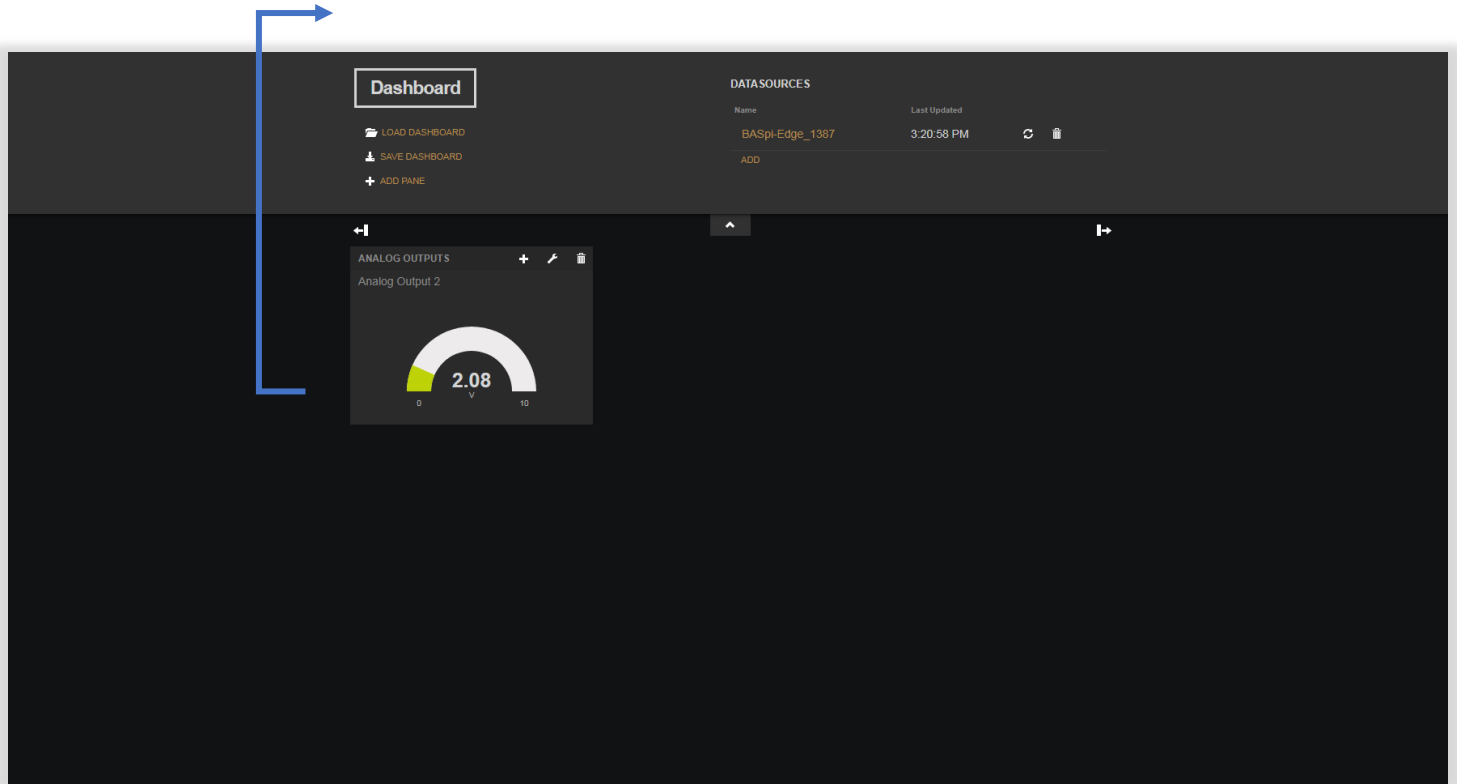

Widget properties can be edited by clicking the wrench icon in the Widget's upper right corner. Pane properties can be edited by clicking the wrench icon in the Pane's upper right corner.

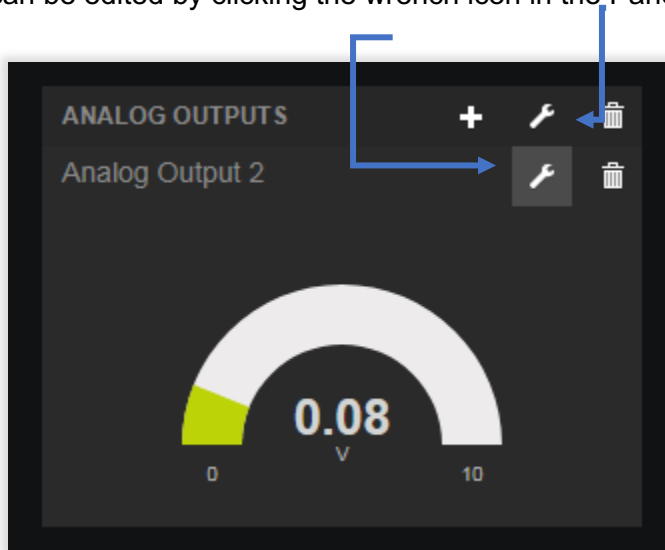

Repeat the process to add a second widget to the same pane or create a new pane. Both BASpi-Edge analog outputs are now added to the first pane. Widget order of appearance within the same pane can be changed as needed by clicking the small arrow on a given widget in a given pane.

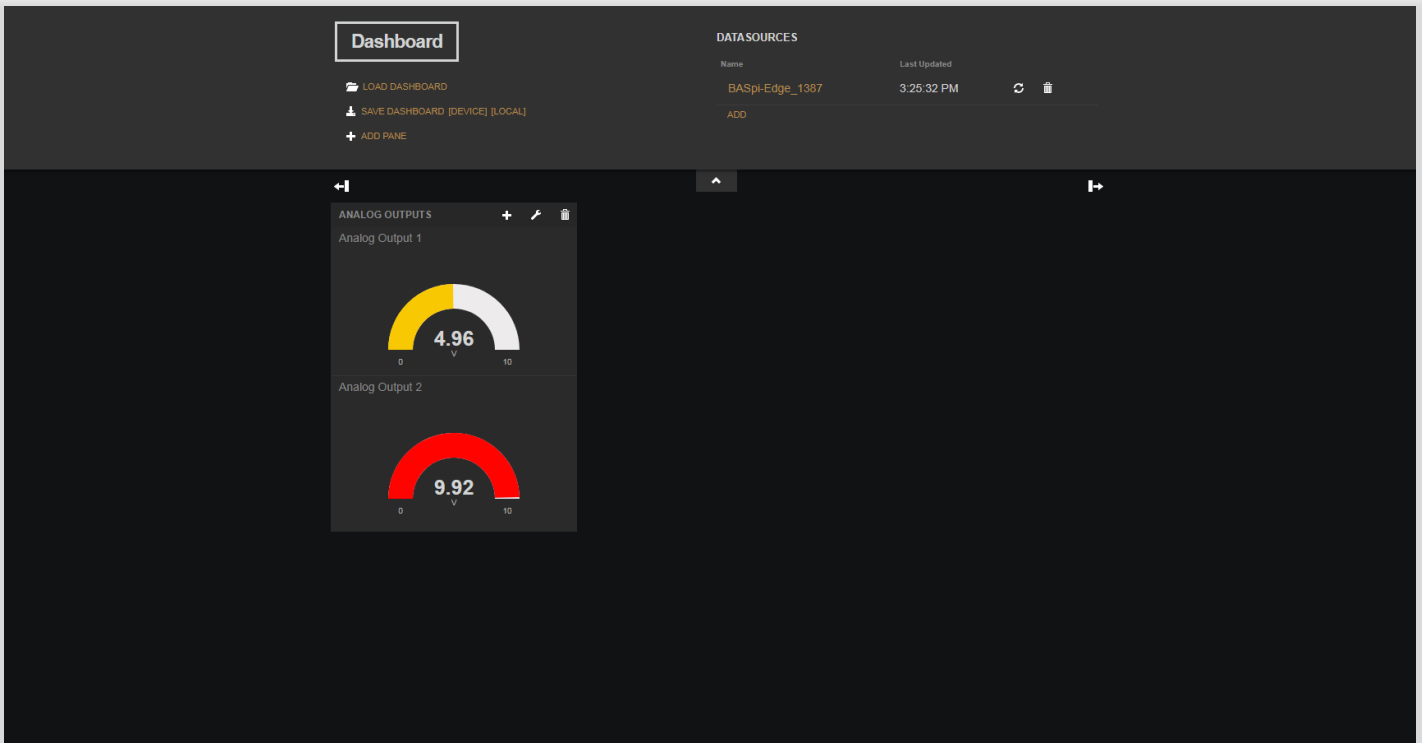

7.1.7 Create Another Pane (Sparkline)

The Sparkline widget allows you to graph point values without a time axis. The difference with this chart is that no time frame is configured or shown, and more than 3 points can be added to the same chart, useful for comparison of multiple point values. A new pane with 2 columns was created and the Sparkline widget configured to graph Analog Output 1 and Analog Output 2 values.

The 'WIDGET' configuration screen shows the following settings:

- TYPE:** Sparkline
- TITLE:** Analog Ouputs Sparkline
- VALUE:**
 - datasources["BASpi-Edge_1387"]["Analog Output 1"]
 - + ADD: datasources["BASpi-Edge_1387"]["Analog Output 2"]
- INCLUDE LEGEND:** YES
- LEGEND:** AO1 and AO2 Voltage

Buttons for '+ DATASOURCE' and '.JS EDITOR' are visible next to each value field. A 'SAVE' button is at the bottom right.

In this Sparkline chart, we can observe that one of the point values peaks above the other.

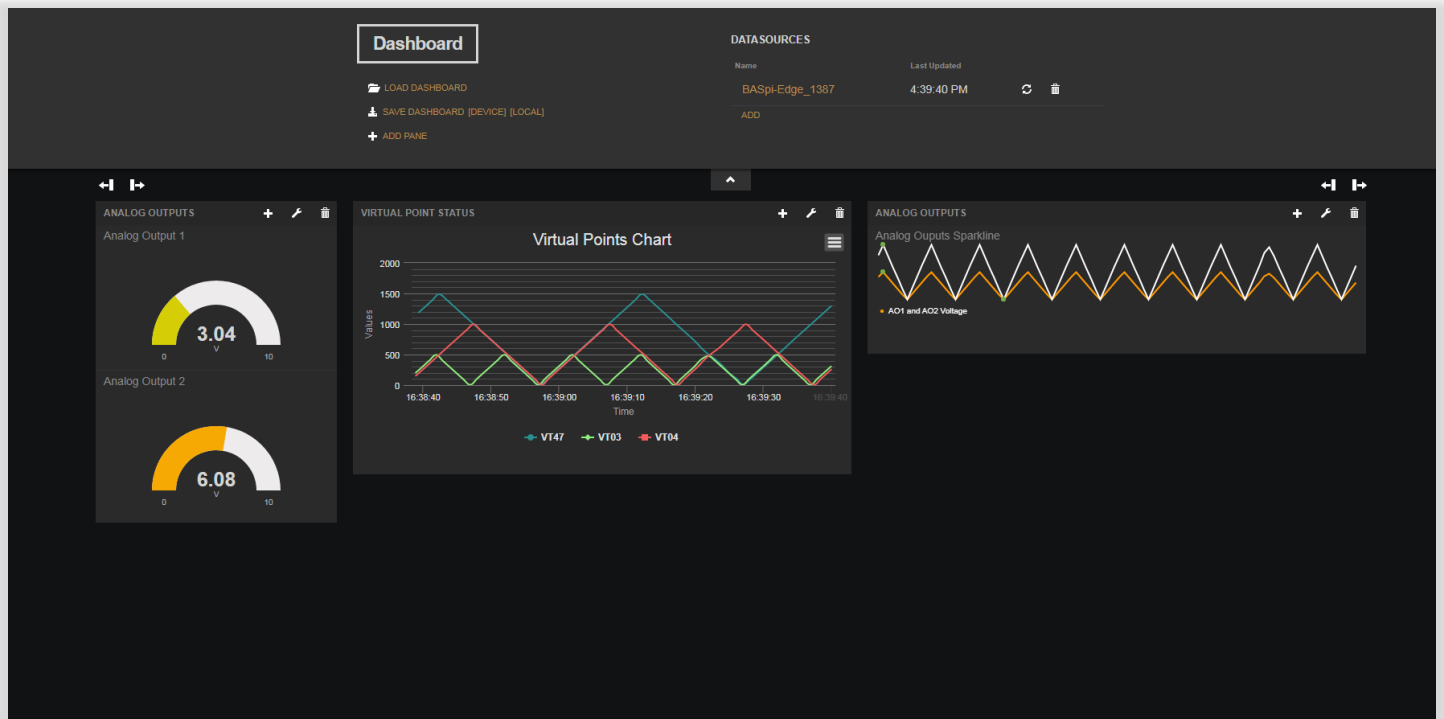

7.1.8 Create Another Pane (Indicator)

A new pane with column size of 1 was created to use the Indicator Light widget to indicate Binary Output states.

The 'WIDGET' configuration interface shows the following settings for an 'Indicator Light' widget:

- TYPE:** Indicator Light
- TITLE:** BO1
- VALUE:** `datasources["BASpi-Edge_1387"]['Binary Output 1']`
- ON TEXT:** ENGAGED
- OFF TEXT:** DISENGAGED

Each text field has a '+ DATASOURCE' and 'JS EDITOR' icon to its right. A blue arrow points from the 'OFF TEXT' field to the 'ON TEXT' field.

This widget allows for ON text and OFF text to be defined to anything which makes sense in the particular application. In this example ENGAGED was defined for ON text and DISENGAGED for OFF text for BO1, ON and OFF for BO2, and ENABLED and DISABLED for BO3.

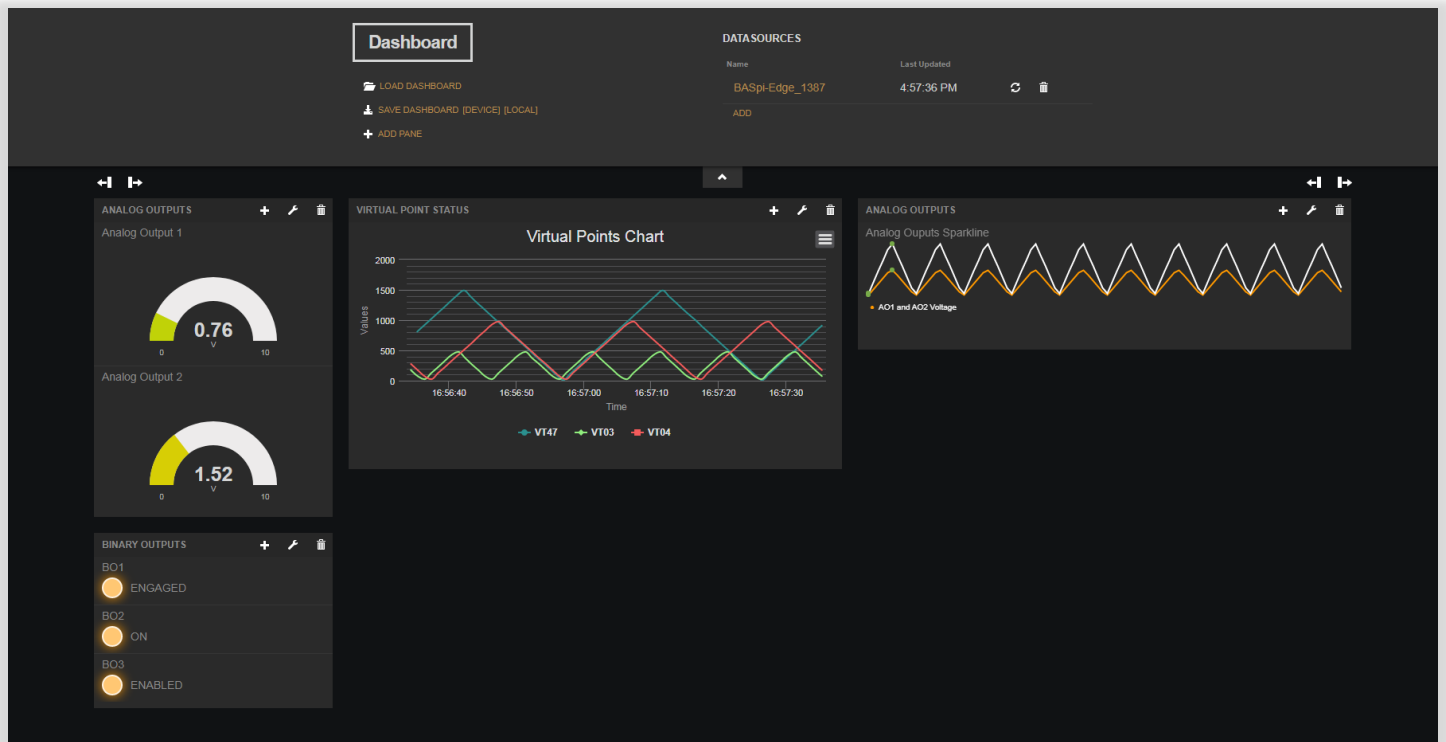

7.1.9 Create Another Pane (Slider)

A new pane with column size of 2 was created to use the Slider widget to drive Virtual Point 44 configured as Temperature Setpoint input to wire sheet.

WIDGET

Interactive Slider Plugin

TYPE	Slider			
TITLE	Zone Temperature Setpoint			
MIN	0	+ DATASOURCE	.JS EDITOR	
MAX	100	+ DATASOURCE	.JS EDITOR	
VALUE	<code>datasources["BASpi-Edge_1387"]["Virtual Point 44"]</code>	+ DATASOURCE	.JS EDITOR	
VALUE ON CHANGED	<code>%VALUE%</code>	+ DATASOURCE	.JS EDITOR	

SAVE
CANCEL

Using your mouse on PC/laptop or your finger on touchscreens/tablets allows you to set the slider to a desirable value which will then be written into the Sedona wire sheet logic Virtual Point 44 – in this case set up as a temperature setpoint.

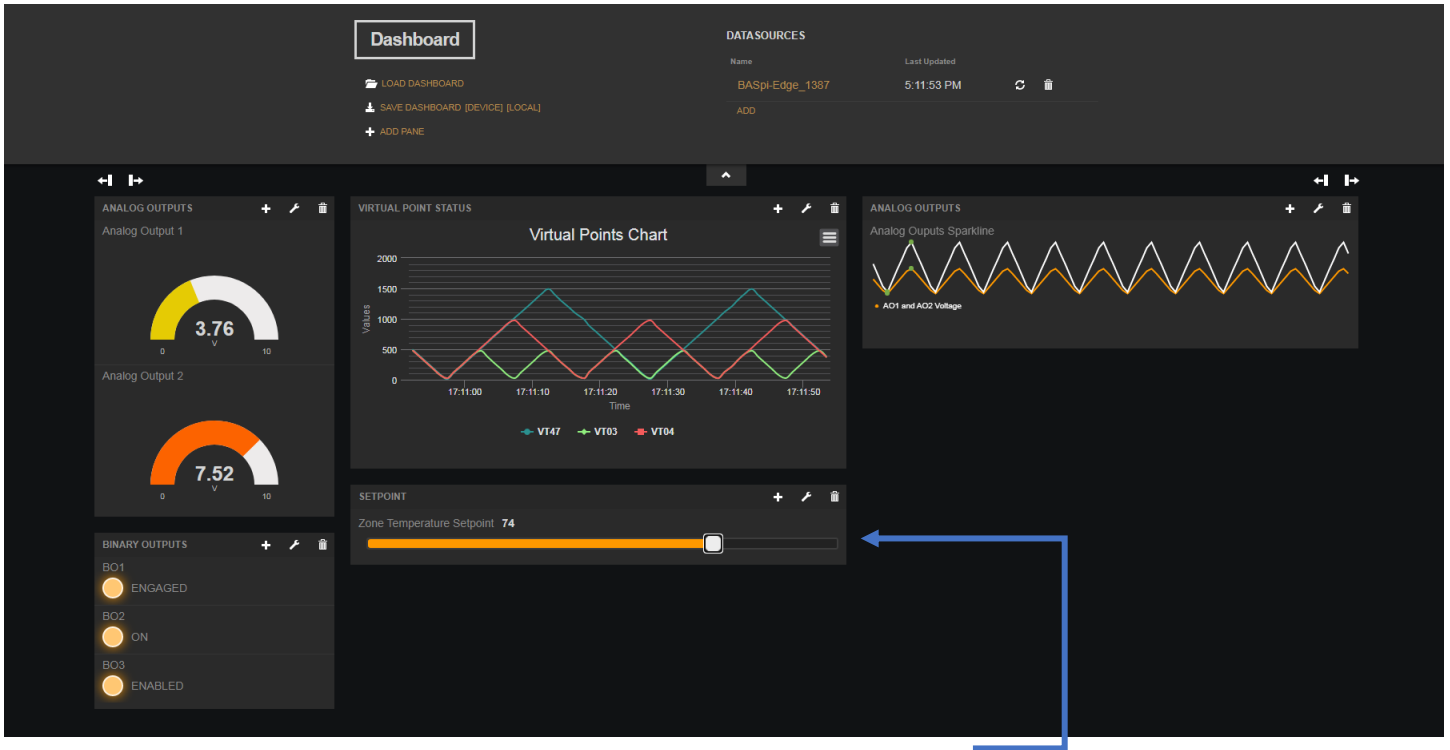

In the Dashboard example above, 74 was set on the Slider widget which is then used by the assigned Virtual Point 44 configured as input to wire sheet in the Sedona wire sheet logic.

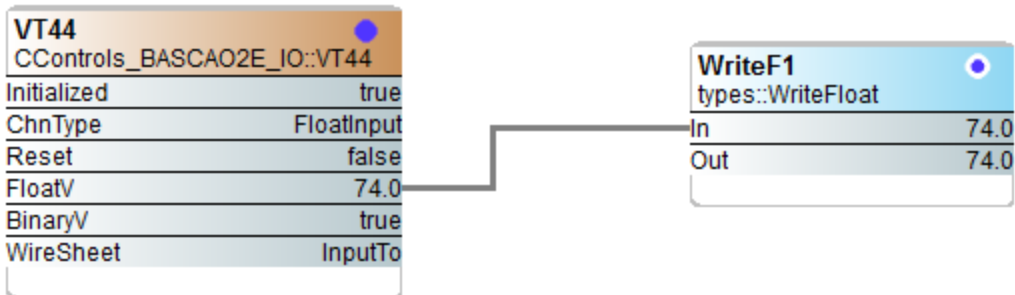

The dashboard created using the web interface can be saved/loaded to LOCAL or DEVICE as a dashboard.json file.

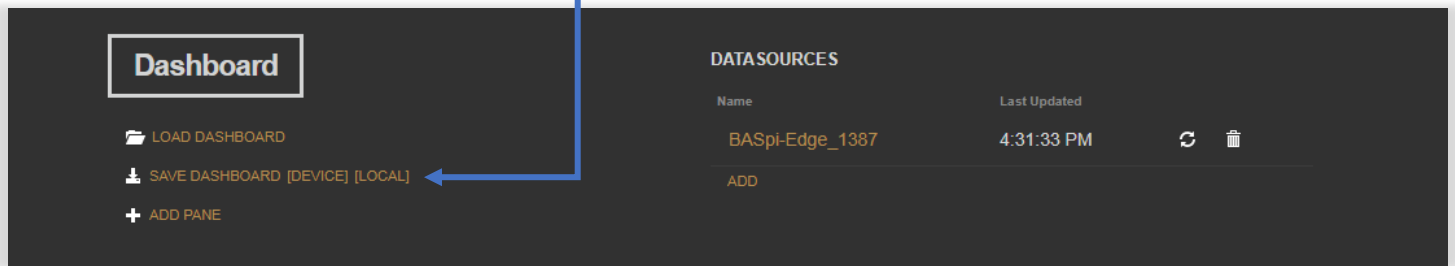

A dashboard.json file saved to LOCAL is saved directly to the Downloads folder (default folder configured in the PC web browser) on the PC/laptop/tablet used to configure the dashboard and will be the dashboard seen on that PC/laptop.

The dashboard.json file can be transferred to other PC/laptop/tablet devices on the IP network, however BASpi-Edge can only serve one dashboard instance at a time.

When finished with setup and the dashboard had been saved to LOCAL or DEVICE, click the wrench icon to hide configuration.

7.1.10 Complete Dashboard Examples

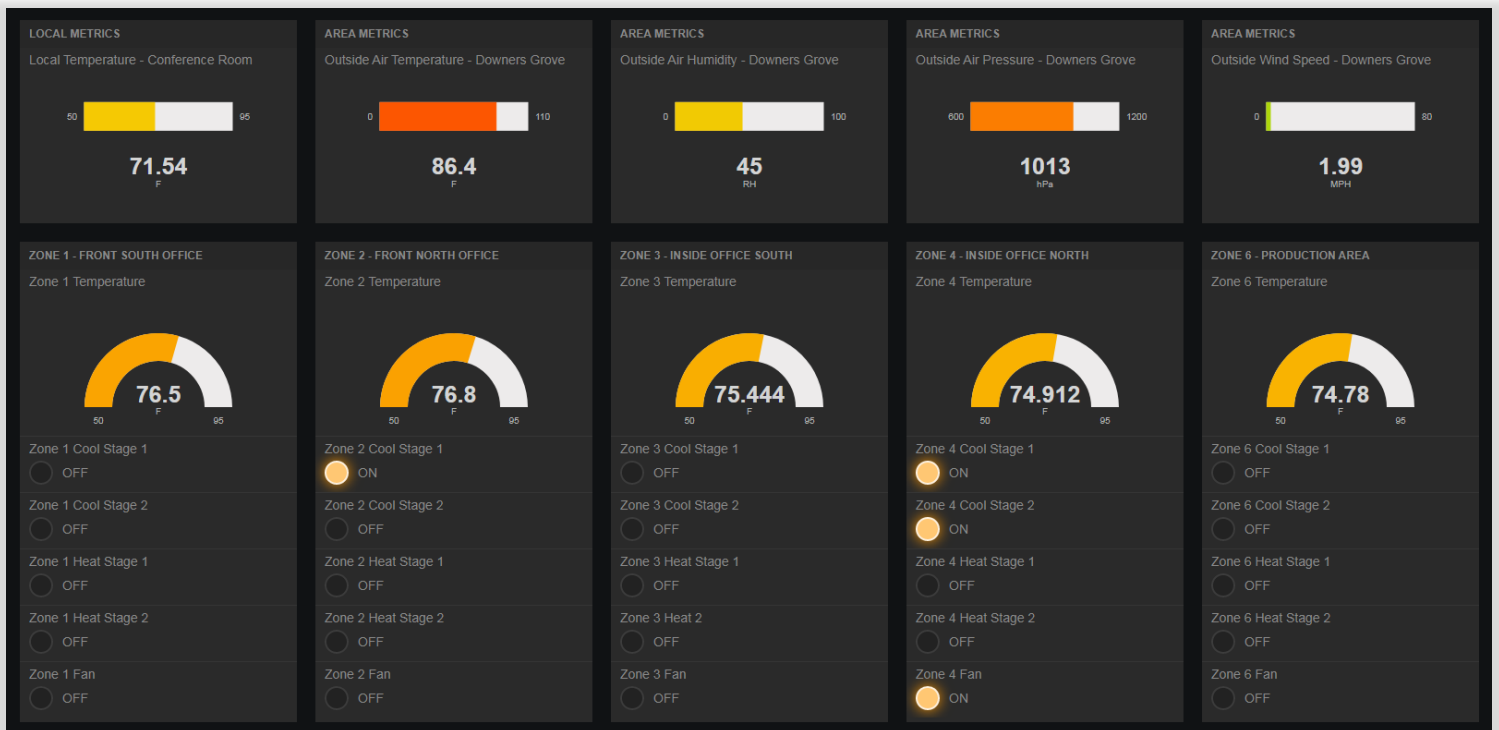



WARNING: Only one Dashboard instance is supported by a single BASpi-Edge. This Dashboard can be served over one source only whether it is Ethernet, Wi-Fi, or HDMI output.

7.2 HDMI Screen Setup

To set up a graphical dashboard with direct output to a screen/monitor, an HDMI connection is required. HDMI cable can only be plugged in while the BASpi-Edge is powered off. Connect a standard type A HDMI cable between the BASpi-Edge and the screen of your choice.

WARNING: Do not connect/disconnect HDMI cable while the BASpi-Edge is powered on. Always power the BASpi-Edge off when plugging/unplugging HDMI cable.



The graphical dashboard setup for HDMI output is identical as outlined in the web-based setup above, except the dashboard needs to be saved to DEVICE instead of LOCAL. A dashboard saved to DEVICE (saved directly on BASpi-Edge) will be the dashboard seen through the HDMI output connection. Once finished with web-based setup of a Dashboard and you want this to be displayed out of the HDMI output, click Save button and then the DEVICE button and a confirmation message from the BASpi-Edge with its IP address will be shown, indicating that the dashboard had been saved. Click Ok.

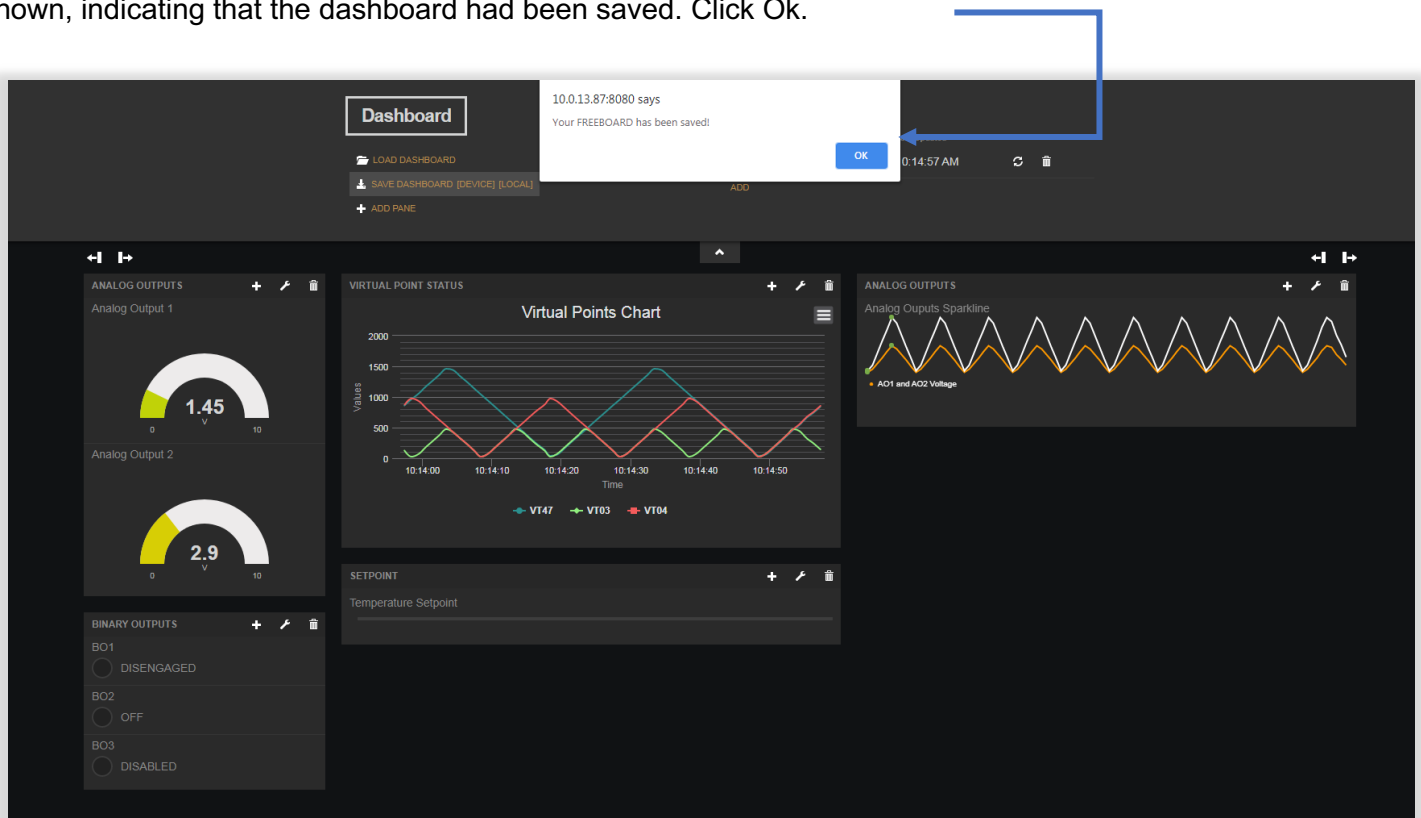

A Restart OS command is required to make the dashboard active on the HDMI connected screen. Right click on any of the access buttons on the main web page and choose Restart OS option from the dropdown.

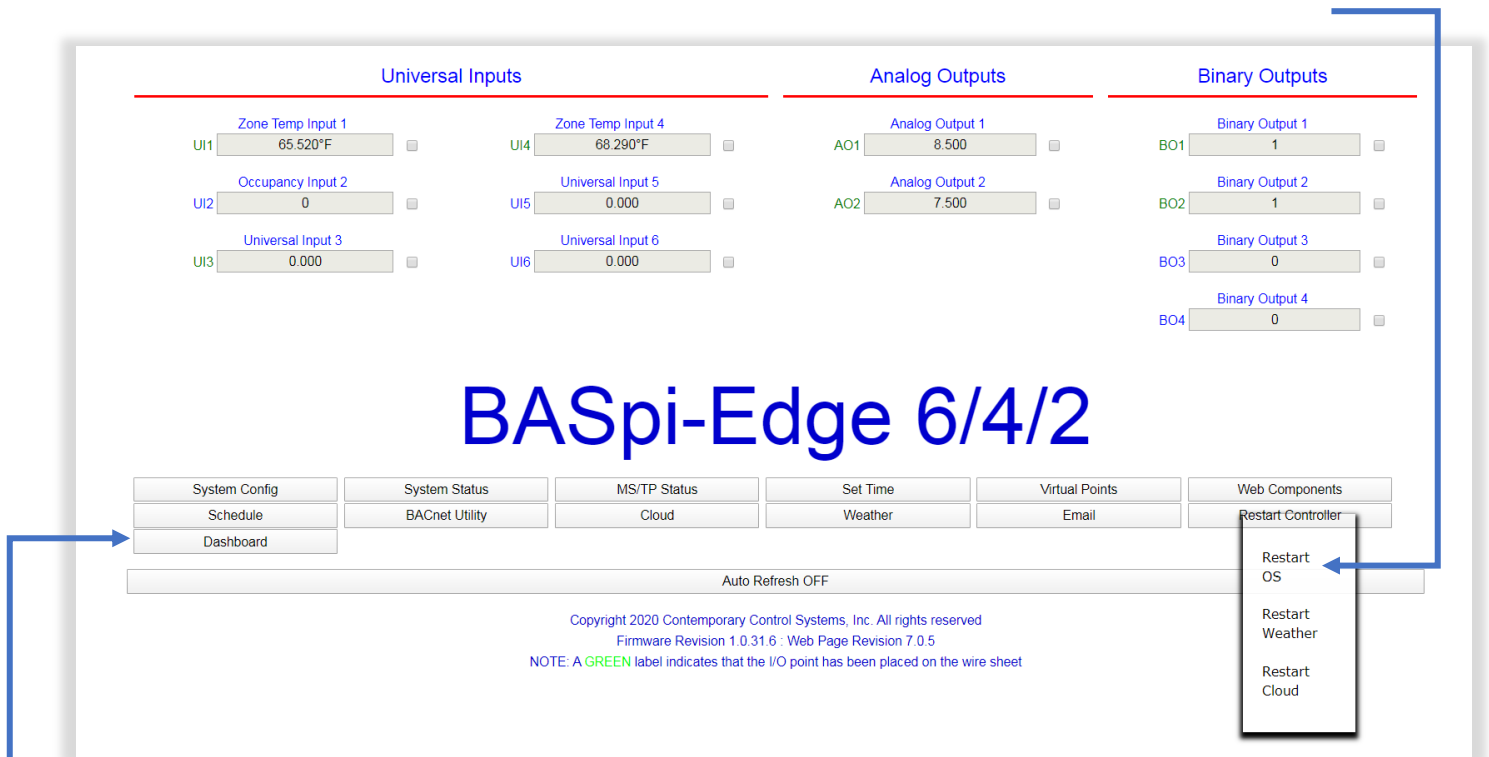

After the reboot, the BASpi-Edge web page login prompt will be shown. A mouse/keyboard input is required to enter in the login credentials. Plug in a USB connected mouse and keyboard to the available USB ports. Enter in the BASpi-Edge username and password as you had previously configured it on the System Configuration web page and click Sign In. The web browser will ask if you want to remember the login credentials. If you want to avoid entering the login credentials in the event the BASpi-Edge loses power and the dashboard is restarted, you could choose to store them in the BASpi-Edge web browser.

The BASpi-Edge main web page is shown after authenticating. Click the Dashboard button and observe the dashboard appear on your HDMI connected screen. Dashboards cannot be edited/configured using the connected screen. The wrench icon used to configure the Dashboard is not shown on HDMI output.

7.3 HDMI Touchscreen Human-Machine Interface Setup

To set up a touchscreen human-machine interface (HMI), both HDMI and USB connections are required. The additional USB connection is required to enable the touch input functionality of touchscreens. HDMI cable can only be plugged in while the BASpi-Edge is powered off. Connect a standard type A HDMI cable and a USB type A cable between the BASpi-Edge and the touchscreen of your choice.

WARNING: Do not connect/disconnect HDMI cable while the BASpi-Edge is powered on. Always power the BASpi-Edge off when plugging/unplugging HDMI cable. USB cables can be plugged/unplugged while BASpi-Edge is powered on.



The graphical dashboard setup for HDMI output is identical as outlined in the web-based setup above, except the dashboard needs to be saved to DEVICE instead of LOCAL. A dashboard saved to DEVICE (saved directly on BASpi-Edge) will be the dashboard seen through the HDMI output connection. Once finished with web-based setup of a Dashboard and you want this to be displayed out of the HDMI output, click Save button and then the DEVICE button and a confirmation message from the BASpi-Edge with its IP address will be shown, indicating that the dashboard had been saved. Click Ok.

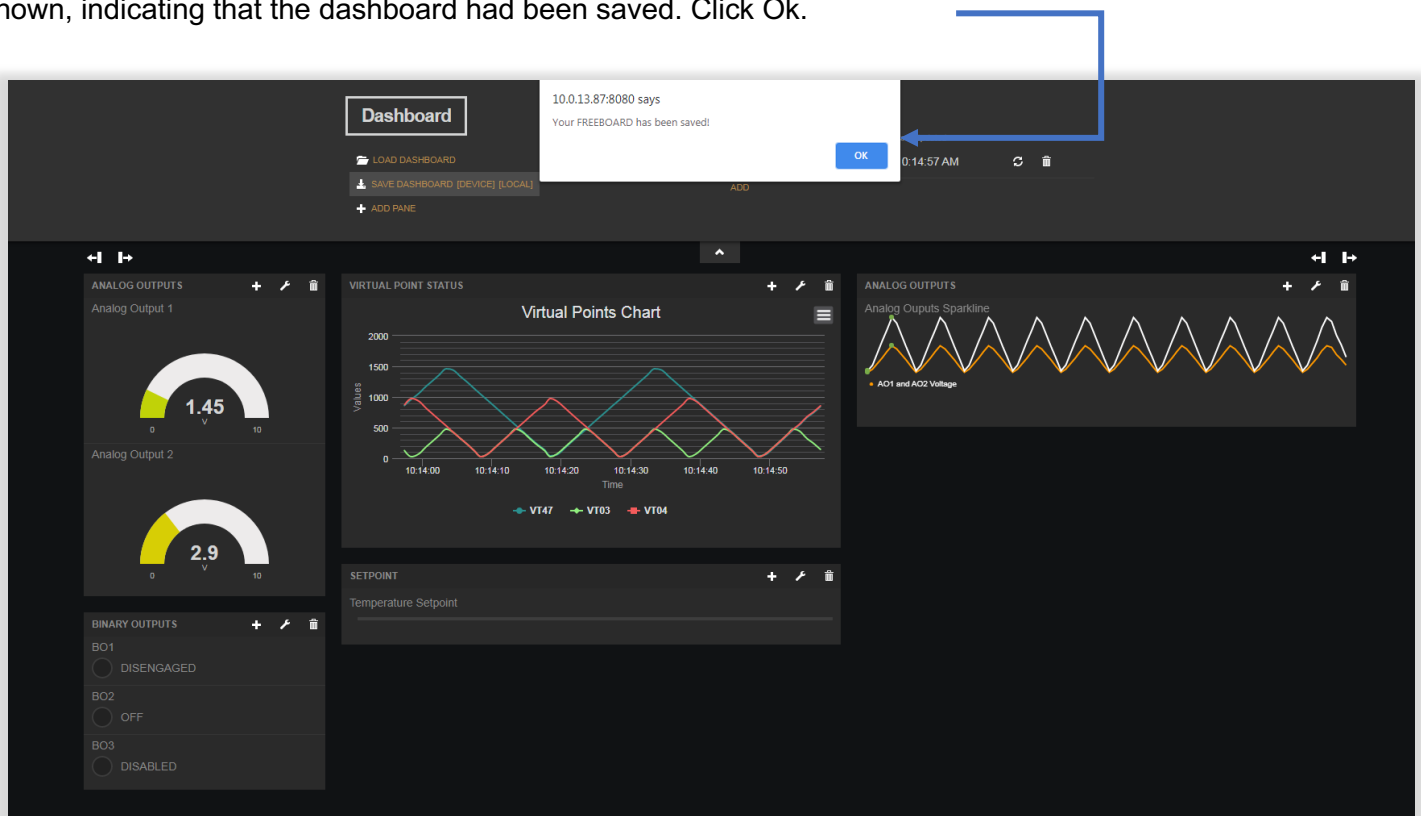

A Restart OS command is required to make the dashboard active on the HDMI connected touchscreen. Right click on any of the access buttons on the main web page and choose Restart OS option from the dropdown.

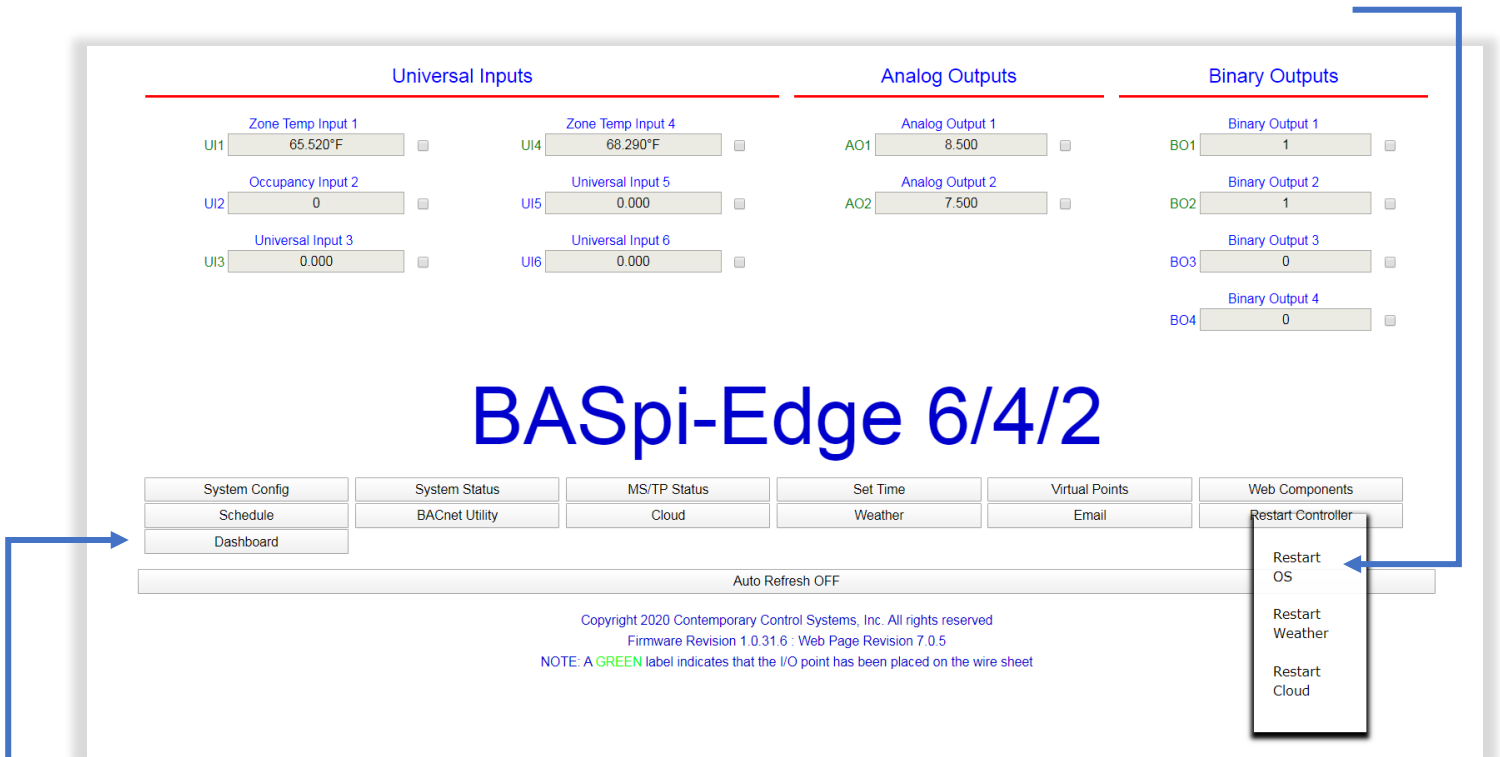

After the reboot, the BASpi-Edge web page login prompt will be shown. A mouse/keyboard input is required to enter in the login credentials. Plug in a USB connected mouse and keyboard to the available USB ports. Enter in the BASpi-Edge username and password as you had previously configured it on the System Configuration web page and click Sign In. The web browser will ask if you want to remember the login credentials. If you want to avoid entering the login credentials in the event the BASpi-Edge loses power and the dashboard is restarted, you could choose to store them in the BASpi-Edge web browser.

The BASpi-Edge main web page is shown after authenticating. Click the Dashboard button and observe the dashboard appear on your HDMI connected touchscreen. Dashboards cannot be edited/configured using the connected touchscreen. The wrench icon used to configure the Dashboard is not shown on HDMI output. If you chose to remember the login credentials in the BASpi-Edge web browser, there is no need to connect USB mouse and keyboard in the event of power loss when the BASpi-Edge and the dashboard are restarted. Using the touchscreen, the Sign In button and then the Dashboard button could be clicked to access the dashboard on the touchscreen. If login credentials need to be entered in, the USB mouse and keyboard inputs are required to access the Dashboard.

NOTE: It is advisable to use Virtual Points in Dashboards especially in HMI (Human-Machine-Interface) applications where outputs can be engaged by users of the touchscreen. This gives the integrator the opportunity to create additional safety logic between the Virtual Point displayed on the HMI and the physical output being engaged/disengaged.

8 Sedona

Sedona is a function block programming language used to create sequence of operation programs. As a Sedona developer, Contemporary Controls has produced several products utilizing Sedona. In addition to UM-18050000-AA2

developing custom Sedona components that complement those originally developed in the open source technology, Contemporary Controls has developed a free Sedona programming tool called the Sedona Application Editor (SAE) needed to program Sedona devices. The required kits and manifests for the connected BASpi-Edge Sedona device are also provided in the Component_Bundle_BASC as part of the tool installation. Contemporary Controls provides everything necessary for its series of Sedona products with the [BAScontrol Toolset download](#).

The BASpi-Edge incorporates the Sedona Virtual Machine (SVM). Once developed, the Sedona wire sheet program remains stored in the BASpi-Edge and executes in the SVM. The application can run standalone in the BASpi-Edge, or it can interact with a program in a supervisory BACnet controller over Ethernet or Wi-Fi or optional MS/TP dongle. The number of potential applications is unlimited.

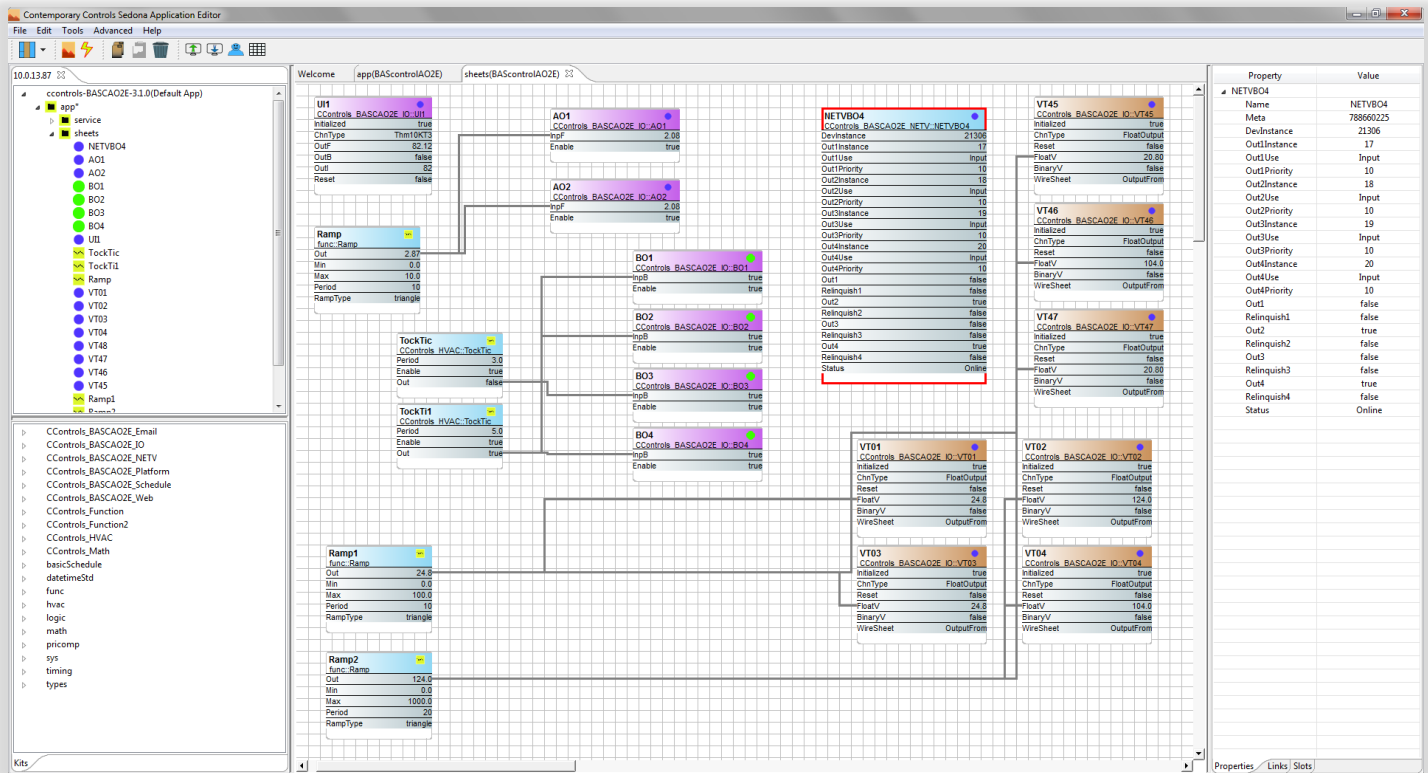

The BASpi-Edge includes Sedona 1.2 kits and Contemporary Controls' enhanced platform dependent and universal functionality kits.

- ▷ CControls_BASCAO2E_Email
- ▷ CControls_BASCAO2E_IO
- ▷ CControls_BASCAO2E_NETV
- ▷ CControls_BASCAO2E_Platform
- ▷ CControls_BASCAO2E_Schedule
- ▷ CControls_BASCAO2E_Web
- ▷ CControls_Function
- ▷ CControls_Function2
- ▷ CControls_HVAC
- ▷ CControls_Math
- ▷ basicSchedule
- ▷ datetimeStd
- ▷ func
- ▷ hvac
- ▷ logic
- ▷ math
- ▷ pricomp
- ▷ sys
- ▷ timing
- ▷ types

The BASpi-Edge IO kit provides 12 physical points, 48 BACnet Virtual Points, and 6 Universal Counters. In addition, ScanTime and Sunrise components are also included in the BASpi-Edge IO kit.

6x Universal Input components can be configured for different input types from the web page. These components are only retentive to flash memory when configured for Pulse Input and store data to flash every 30min.

UI1 ●	
CControls_BASCAO2E_IO::UI1	
Initialized	true
ChnType	Thm10KT3
OutF	87.56
OutB	false
OutI	87
Reset	false

6x Output components are available and model dependent to all 6 binary outputs (BASpi-Edge 6/6) or 4 binary outputs and 2 analog outputs (BASpi-Edge 6/4/2).

BO4 ●	
CControls_BASCAO2E_IO::BO4	
InpB	false
Enable	true

AO1	
CControls_BASCAO2E_IO::AO1	
InpF	4.75
Enable	true

ScanTime component reports the execution time parameters of the app.

ScanTim	
CControls_BASCAO2E_IO::ScanTim	
SampleSize	10
TimeMs	1
MinimumMs	0
MaximumMs	1
AverageMs	0
Reset	false

Sunrise component is used in conjunction with time and geolocation settings and provides sunrise and sunset information.

Sunrise	
CControls_BASCAO2E_IO::Sunrise	
IsDaytime	false
MinToSunrise	1440
MinToSunset	1440

UC (Universal Counter) components are used to store wire sheet data to flash at 30 min intervals. These could be used to store rollover counts for Universal Input components set for Pulse Input.

UC1	
CControls_BASCAO2E_IO::UC1	
Initialized	true
Count	0
CountF	0.0
Ovf	true
Clk	false
Enable	true
Rst	false
CDwn	false
Limit	0
HoldAtLimit	false

Virtual Points are BACnet server points which are also utilized in Weather and Cloud configuration.

VT04	
CControls_BASCAO2E_IO::VT04	
Initialized	true
ChnType	FloatOutput
Reset	false
FloatV	65.00
BinaryV	false
WireSheet	OutputFrom

VT48	
CControls_BASCAO2E_IO::VT48	
Initialized	true
ChnType	FloatInput
Reset	false
FloatV	0.0
BinaryV	false
WireSheet	InputTo

BASpi-Edge Web Kit has 48 components which share data with its web page and can be used for configuration points. Input web components receive data from the web page. Output web components send data to the web page.

WC01	
CControls_BASCAO2E_Web::WC01	
WcType	Input
MinVal	0.0
MaxVal	100.0
FltVal	0.0
IntVal	0
BinVal	false

The Contemporary Controls' BASpi-Edge Email component allows for emails to be triggered.

Email	
CControls_BASCAO2E_Email::Email	
MessageID	1
Sv1	0.0
Sv2	75.5
Sv3	0.0
Trigger	false
Reset	false
Status	Success

The Contemporary Controls' BASpi-Edge Schedule component allows for schedules to be triggered.

Sched 	
CControls_BASCAO2E_Schedule::Sched	
SchedName	RTU1
IsOccupied	true
MinToOccupied	1440
HeadActive	false
HeadOccupied	false
Status	Configured

The Contemporary Controls' BASpi-Edge NetV components allow for BACnet points to be obtained over the network and utilized in the BASpi-Edge wire sheet and other services such as Cloud and Dashboard.

NetV 	
CControls_BASCAO2E_NETV::NetV	
DevInstance	0
ObjInstance	0
ObjType	AnalogInput
Priority	10
DefOutF	0.0
DefOutB	false
DefOutI	0
ValF	0.0
ValB	false
ValI	0
Relinquish	false
Enabled	false
Status	NotConfigured

NETVBO4	
CControls_BASCAO2E_NETV::NETVBO4	
DevInstance	21306
Out1Instance	17
Out1Use	Input
Out1Priority	10
Out2Instance	18
Out2Use	Input
Out2Priority	10
Out3Instance	19
Out3Use	Input
Out3Priority	10
Out4Instance	20
Out4Use	Input
Out4Priority	10
Out1	false
Relinquish1	false
Out2	false
Relinquish2	false
Out3	false
Relinquish3	false
Out4	true
Relinquish4	false
Status	Online

Function, Function2, HVAC, and Math kits provide enhanced logic functionality.

The complete set of compatible kits is pre-installed on the BASpi-Edge from the factory. In order to install additional compatible kits such as custom kits developed or obtained through third parties, use the Kit Manager in Sedona Application Editor (SAE) by clicking on the Advanced menu item at the top and selecting Kit Manager. There is no need to use the Kit Manager unless you have compatible kits from third parties which need to be installed on BASpi-Edge.

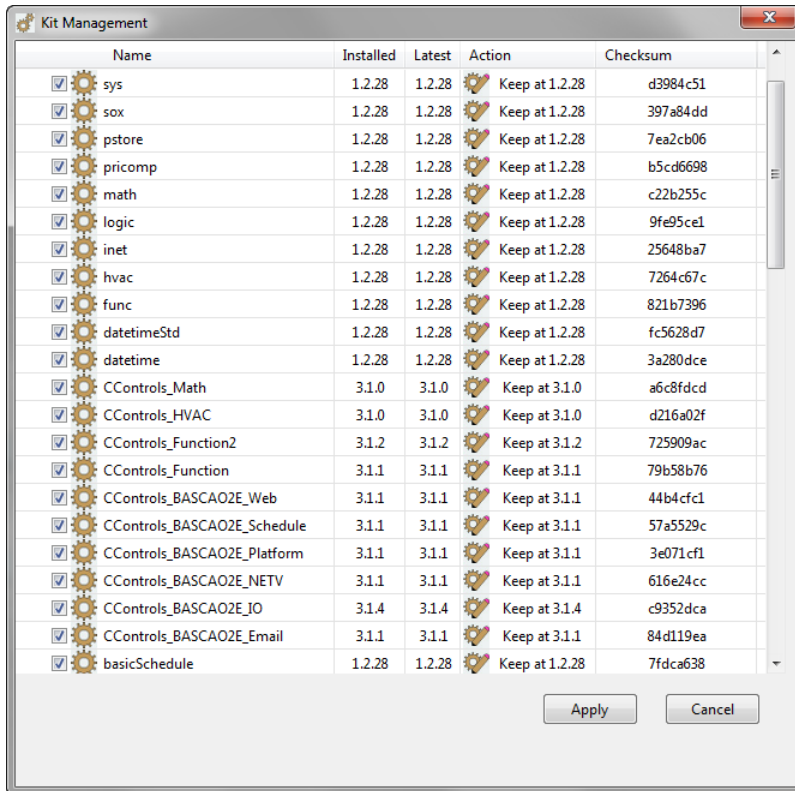

For complete details on Sedona Framework, SAE, and Sedona component functionality refer to the [Sedona Open Control Reference Manual](#).

9 Software Tools

9.1 BAScontrol Toolset

The BAScontrol Toolset is offered as a [free download](#). It consists of the Sedona Application Editor, BASbackup and BASemulator tools.

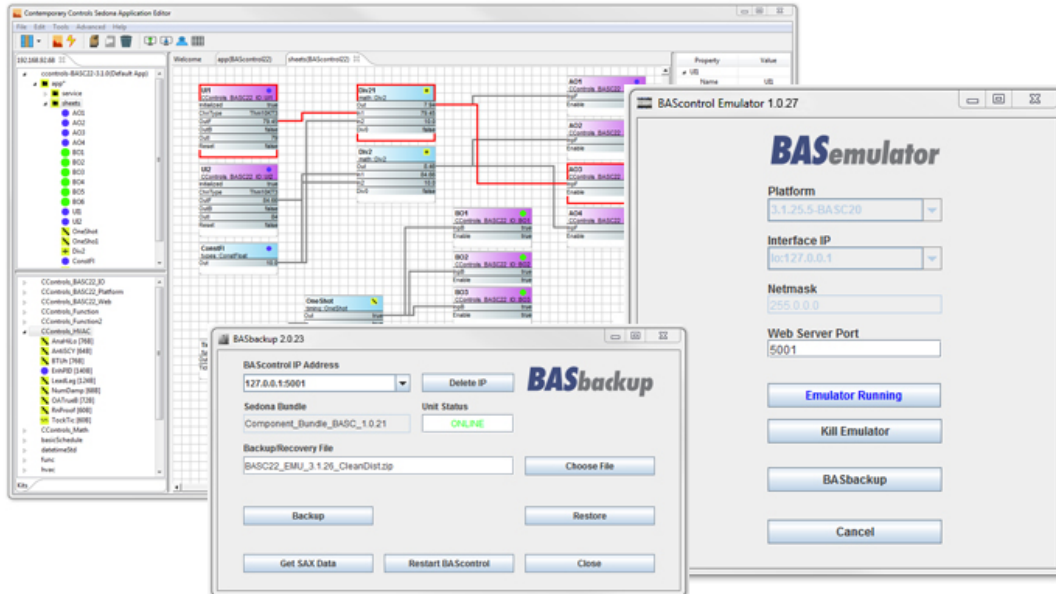

Sedona programming can be accomplished over Ethernet or Wi-Fi using the Sedona Application Editor (SAE) tool.

Backup or restore operations of complete projects can be accomplished over Ethernet or Wi-Fi using the BASbackup tool.

BASemulator emulates BASpi-Edge operation on your Windows PC for ease of application development, even when the real BASpi-Edge unit is not in front of you. Transferring projects between real and emulated BASpi-Edge devices is accomplished using BASbackup.

9.2 Sedona Programming / Data Processing

Sedona Application Editor (SAE) – used to connect to Sedona devices such as BASpi-Edge and program function block wire sheet control applications and saving or loading local wiresheet application (SAX file) on a Windows PC/laptop.

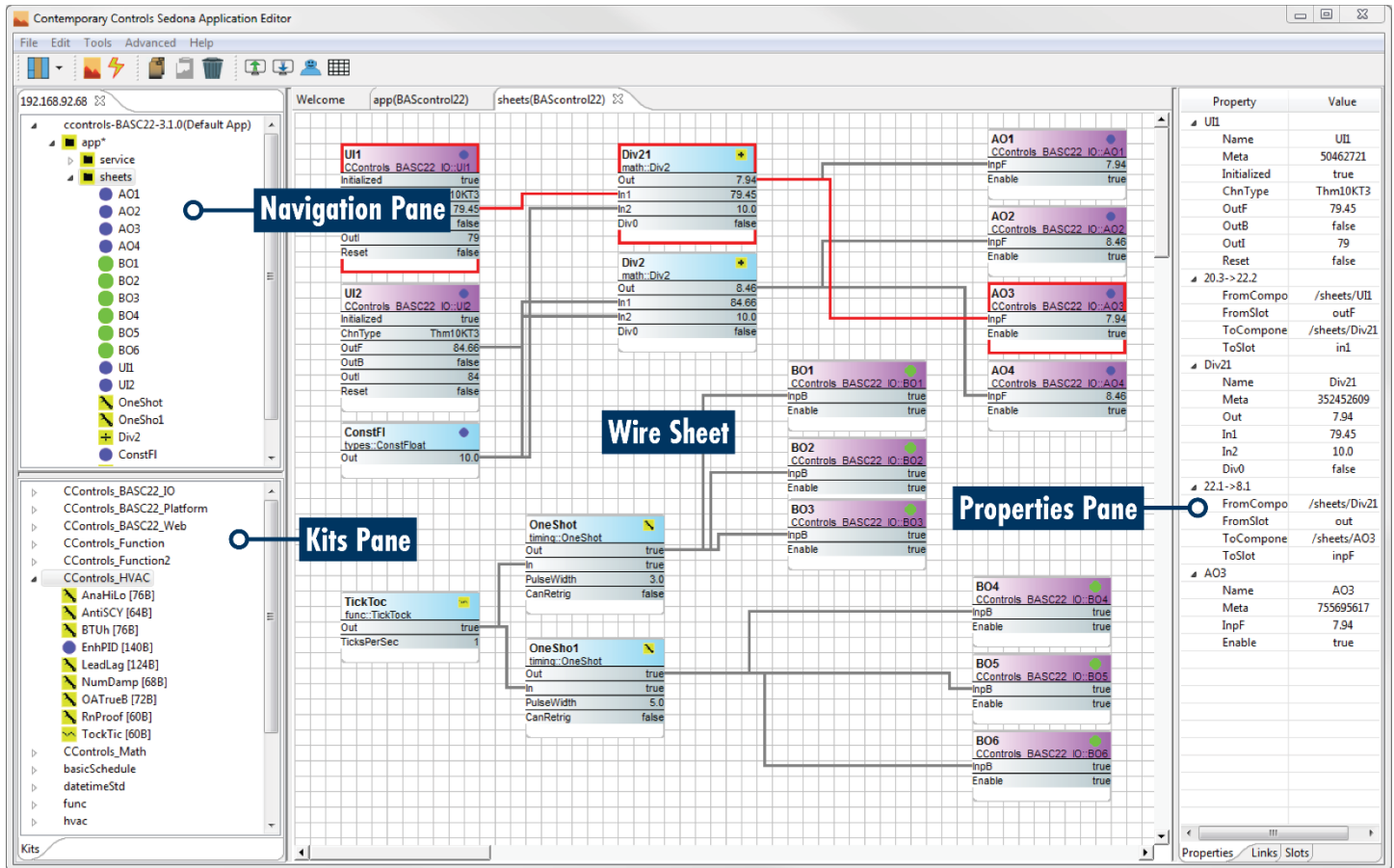

9.3 Project Backup and Restore

BASbackup – allows you to store complete BASpi-Edge projects (wire sheet logic and web page configuration) to a single file. This file can be used as a backup for archiving, or a template for similar future projects. The transferrable backup file (template) can be used to clone controllers or quickly reproduce controllers with slightly altered settings to save time. BASbackup can transfer emulated projects to real BASpi-Edge devices.

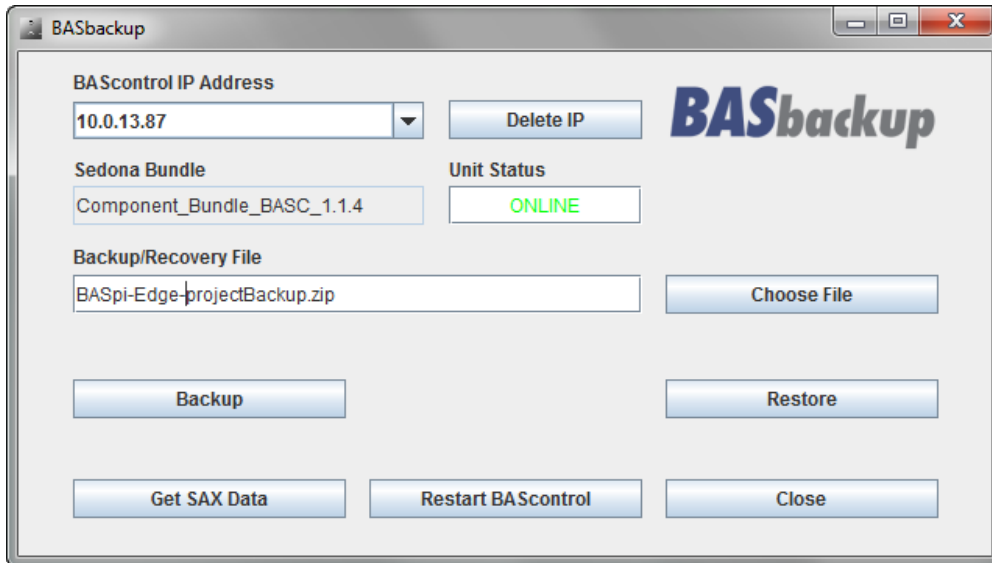

9.4 BASpi-Edge Emulation

BASemulator – is a software emulator for the BASpi-Edge series which runs on Windows. This BASpi-Edge emulator allows you to work on your projects even when the unit is not in front of you - program your Sedona wire sheet application and configure parameters such as I/O Channel configuration, BACnet settings, and Network settings before deploying onto real controllers. BASpi-Edge project files are transferred between real and emulated BASpi-Edge using BASbackup.

Choose BASpi-Edge under Platform and click Start Emulator to begin BASpi-Edge emulation on PC.

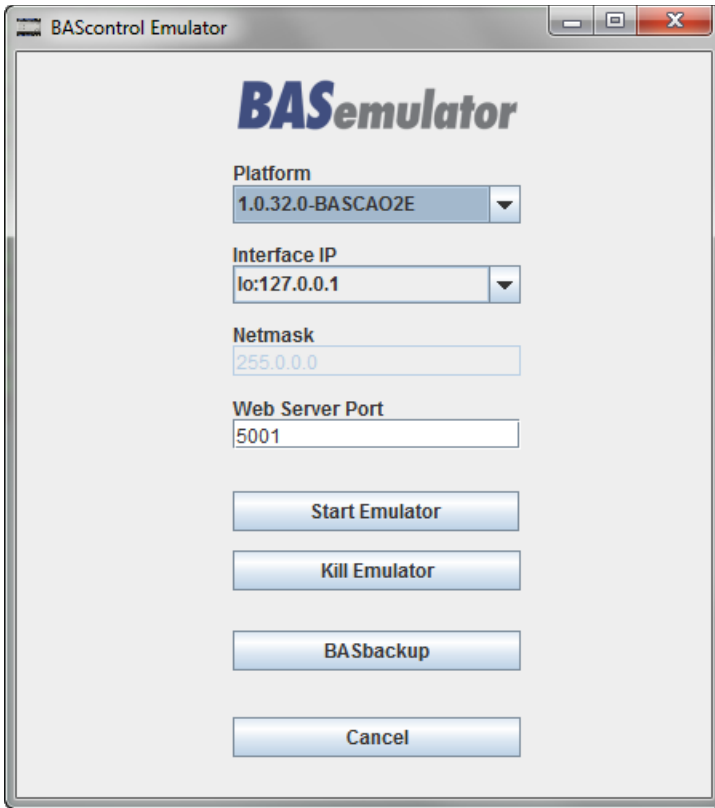

Once the emulator is running, a web page will open which can be used to apply configuration and Sedona Application Editor (SAE) can be used to connect to 127.0.0.1 to develop wire sheet sequence of operation.

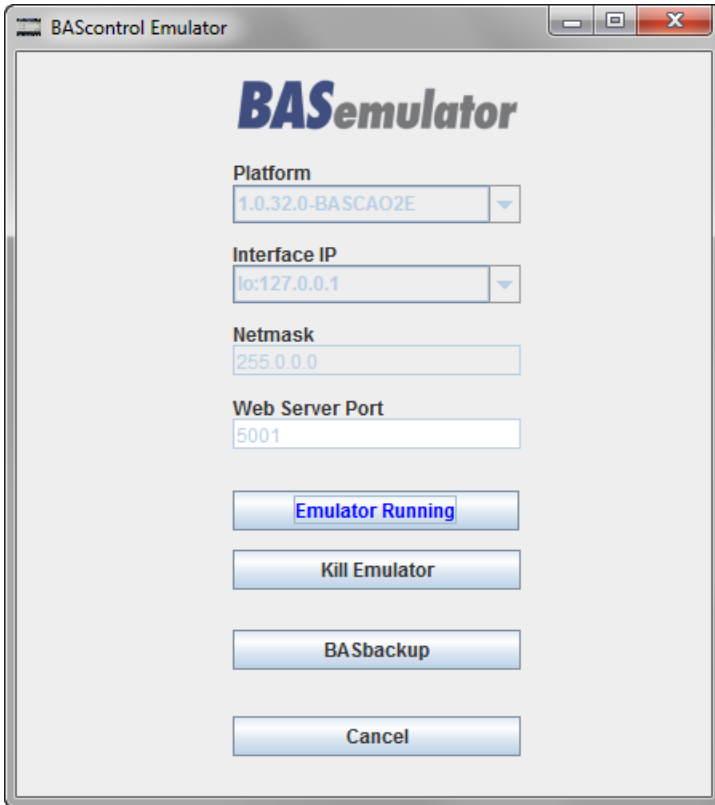

The Emulated BASpi-Edge web page can be used to configure the emulated device. Using BASbackup, this configuration can be transferred to real BASpi-Edge units.

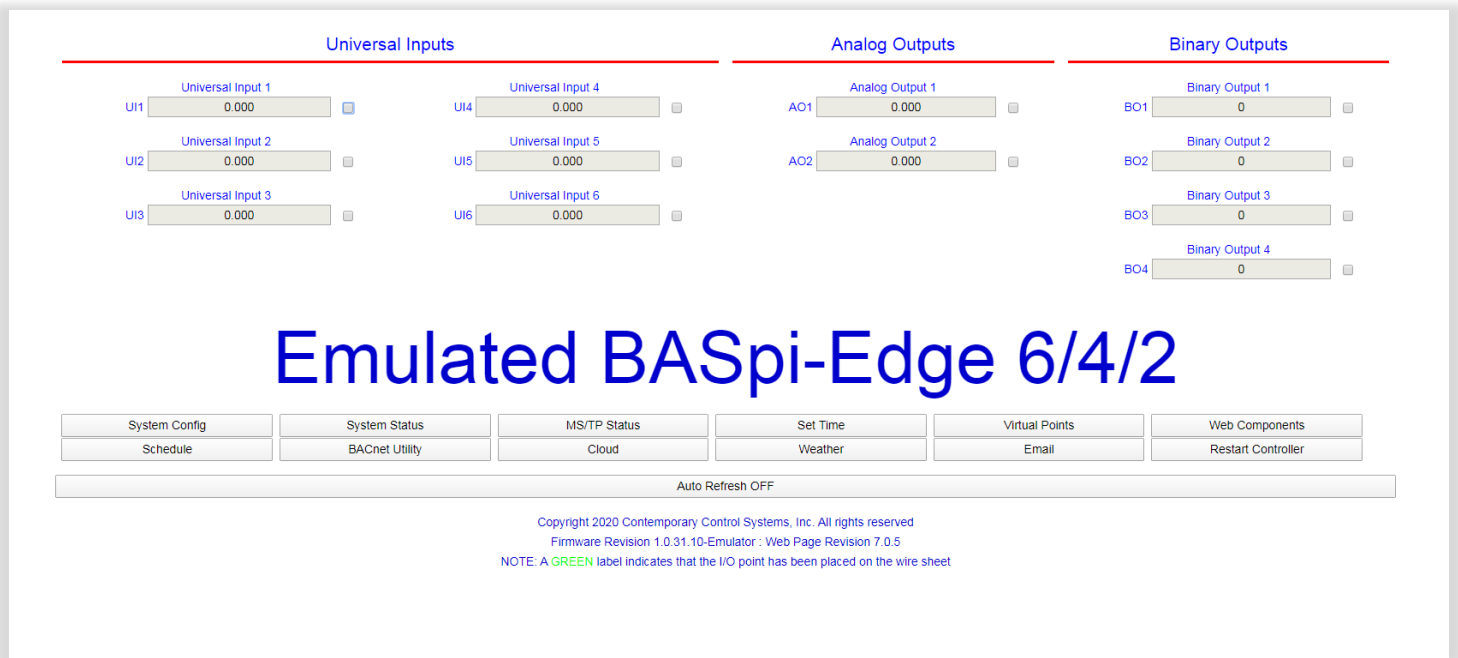

10 REST API

A REST API is offered and can be used to interface between BASpi-Edge 12 points of physical I/O points as well as 48 Virtual Points and third-party, legacy, or non-BACnet devices, custom applications, data servers, etc.

The BASpi-Edge REST interface presents a path-oriented method of reading and writing values from/to the BASpi-Edge using the common GET and SET methods. All data within the BASpi-Edge are accessed as if they are part of an XML document and served in XML data type payload upon request.

For more information on REST API, or to request API documentation, contact our [technical support team](#).

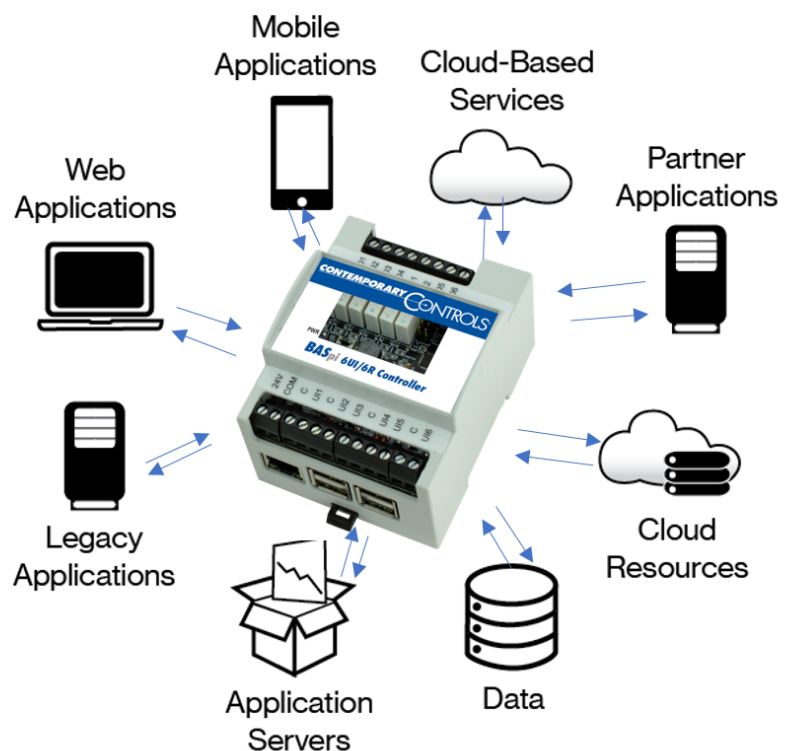

**United States
Contemporary Control
Systems, Inc.**

Tel: +1-630-963-7070
Fax: +1-630-963-0109

info@ccontrols.com

**China
Contemporary Controls
(Suzhou) Co. Ltd**

Tel: +86 512 68095866
Fax: +86 512 68093760

info@ccontrols.com.cn

**United Kingdom
Contemporary Controls
Ltd**

Tel: +44 (0)24 7641 3786
Fax: +44 (0)24 7641 3923

ccl.info@ccontrols.com

**Germany
Contemporary Controls
GmbH**

Tel: +49 341 520359 0
Fax: +49 341 520359 16

ccg.info@ccontrols.com

www.ccontrols.com

CONTEMPORARY CONTROLS®